

AIM APPLE ATARI KIM OSI PET SYM APPLE KIM PET AIM ATARI OSI SYM ATARI PET APPLE OSI AIM KIM AIM KIM AP  
ATARI SYM OSI ATARI AIM PET KIM APPLE SYM APPLE KIM PET AIM ATARI OSI SYM ATARI PET APPLE OSI AIM KIM AIM  
PET KIM ATARI SYM OSI ATARI AIM PET KIM APPLE SYM APPLE KIM PET AIM ATARI OSI SYM ATARI PET APPLE OSI AIM KIM AIM  
OSI SYM ATARI PET APPLE OSI AIM PET KIM APPLE SYM APPLE KIM PET AIM ATARI OSI SYM ATARI PET APPLE OSI AIM KIM AIM  
SYM AIM APPLE KIM PET AIM ATARI PET KIM APPLE SYM APPLE KIM PET AIM ATARI OSI SYM ATARI PET APPLE OSI AIM KIM AIM  
KIM PET APPLE AIM APPLE ATARI KIM PET AIM ATARI OSI SYM ATARI PET APPLE OSI AIM KIM AIM KIM AIM  
APPLE OSI KIM AIM SYM OSI PET ATARI SYM OSI ATARI AIM PET KIM APPLE AIM AIM SYM PET OSI KIM ATARI APPLE AT  
AIM APPLE ATARI KIM OSI PET SYM APPLE KIM PET AIM ATARI OSI SYM ATARI PET APPLE OSI AIM KIM AIM KIM APP  
ATARI SYM OSI ATARI AIM PET KIM APPLE SYM APPLE KIM PET AIM ATARI OSI SYM ATARI PET APPLE OSI AIM KIM AIM  
PET KIM ATARI SYM OSI ATARI AIM PET KIM APPLE SYM APPLE KIM PET AIM ATARI OSI SYM ATARI PET APPLE OSI AIM KIM AIM  
OSI SYM ATARI PET APPLE OSI AIM KIM PET KIM APPLE ATARI AIM PET KIM APPLE AIM AIM SYM PET OSI KIM ATARI APPLE AT  
SYM AIM APPLE KIM PET AIM ATARI SYM OSI ATARI AIM PET KIM APPLE AIM AIM SYM PET OSI KIM ATARI APPLE AT  
KIM PET APPLE AIM PET ATARI KIM PET AIM ATARI OSI SYM ATARI PET APPLE OSI AIM KIM AIM KIM APP  
APPLE OSI KIM AIM SYM OSI PET ATARI SYM OSI ATARI AIM PET KIM APPLE AIM AIM SYM PET OSI KIM ATARI APPLE AT  
AIM APPLE ATARI KIM OSI PET SYM APPLE KIM PET AIM ATARI OSI SYM ATARI PET APPLE OSI AIM KIM AIM KIM APP  
ATARI SYM OSI ATARI AIM PET KIM APPLE SYM APPLE KIM PET AIM ATARI OSI SYM ATARI PET APPLE OSI AIM KIM AIM

# MICRO

## THE 6502 JOURNAL

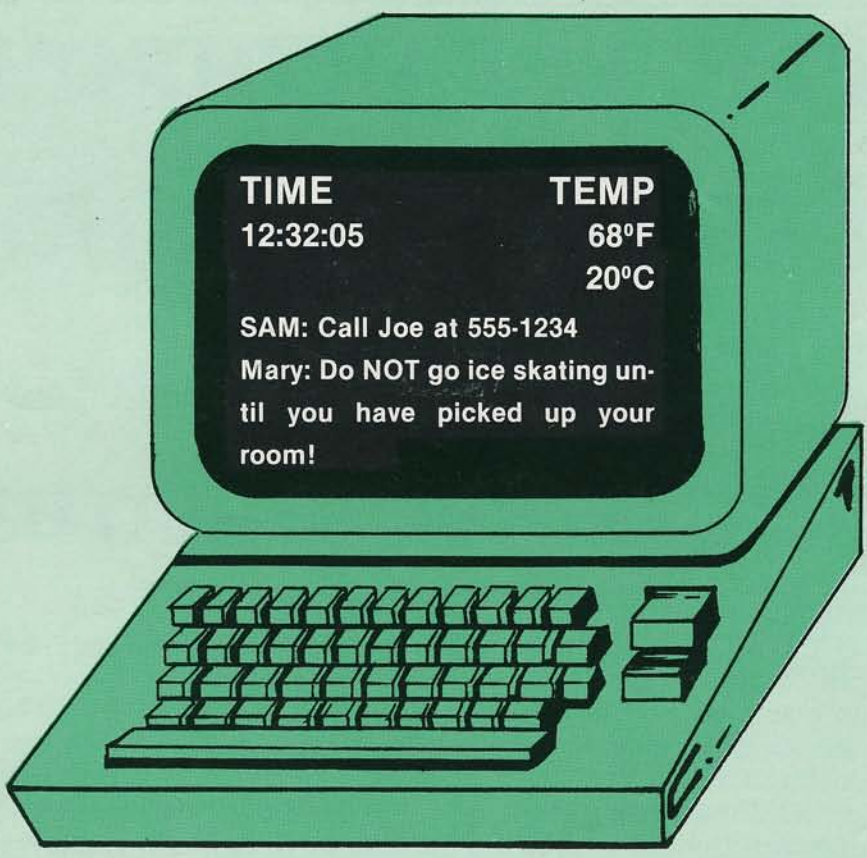

A Digital Thermometer for the APPLE II  
Clocking KIM  
A Home Message Center

AIM APPLE KIM PET AIM ATARI OSI SYM ATARI PET APPLE OSI AIM KIM AIM KIM APPLE PET ATARI SYM OSI ATARI A  
PET APPLE AIM APPLE ATARI KIM APPLE ATARI KIM OSI PET SYM APPLE KIM PET AIM ATARI OSI SYM ATARI PET APP  
LE OSI KIM AIM SYM OSI PET ATARI SYM OSI ATARI AIM PET KIM APPLE AIM AIM SYM PET OSI KIM ATARI APPLE ATARI K  
APPLE ATARI KIM OSI PET SYM APPLE KIM PET AIM ATARI OSI SYM ATARI PET APPLE OSI AIM KIM AIM KIM APPLE P  
RI SYM OSI ATARI AIM PET KIM PET SYM APPLE KIM PET AIM ATARI OSI SYM ATARI PET APPLE OSI AIM KIM AIM APP  
KIM AIM SYM OSI ATARI AIM PET KIM PET SYM APPLE KIM PET AIM ATARI OSI SYM ATARI PET APPLE OSI AIM KIM AIM AT  
SYM ATARI PET APPLE OSI AIM KIM AIM KIM APPLE PET ATARI SYM OSI ATARI AIM PET KIM APPLE AIM APPLE ATARI C  
AIM APPLE KIM PET AIM ATARI OSI SYM ATARI PET APPLE OSI AIM KIM AIM KIM APPLE PET ATARI SYM OSI ATARI A  
PET APPLE AIM APPLE ATARI KIM APPLE ATARI KIM OSI PET SYM APPLE KIM PET AIM ATARI OSI SYM ATARI PET APP  
LE OSI KIM AIM SYM OSI PET ATARI SYM OSI ATARI AIM PET KIM APPLE AIM AIM SYM PET OSI KIM ATARI APPLE ATARI K

NOV-22 MARCH 1980 \$2.00

softside software \$15.95 PET



**ASSEMBLER 2001**  
 full featured mnemonic assembler-disassembler  
 enter save load list run  
 list the secret basic ROMs

softside software \$9.95 PET



**DRIVING ACE**  
 ☆ ☆ 2 ACTION PACKED VIDEO GAMES ☆ ☆ ©1979

# PET BASIC BREAKTHROUGH

## Softside Software presents

### SYMBOLIC/STRUCTURED BASIC

At last, **Symbolic/Structured Basic** is available for your PET 8-32K personal computer! S-Basic is a pre-compiler that enhances the PET's built-in basic monitor with the addition of extra-control statements found only in the most sophisticated computers. **WHILE ... GOSUB ...** calls a subroutine as long as a condition is true. **UNTIL ... GOSUB ...** jumps to a subroutine unless the condition is true. The **IF ... Then ... ELSE** statement allows the programmer to command the computer to execute instructions if the normal IF condition is not met.

**Forget about line numbers**, S-Basic allows you to program naturally only naming (numerically or alphabetically!) statements that you will need to refer to, for ex-

ample: LOOP/PRINT "HI": GO TO LOOP. S-Basic program **lines can be up to 255 characters long**, two-and-one-half times as long as on standard Basic. S-Basic does not compromise any of PET Basic's existing features. All PET Basic commands can be used.

S-Basic includes an **editor** with full text capabilities, a **translator/pre-compiler** with its own error messages, and the **S-Basic loader**. These programs are recommended for disk-based PETs. A printer is optional but suggested. Cassette copies are available and require two cassette drives. Comprehensive instructions are included. Symbolic-/Structured Basic package is available complete for an **introductory price of \$35.95**.

- WHILE....GOTO....
- IF....THEN....ELSE
- 255 CHAR. LINES

**A PET PROGRAMMING BREAKTHROUGH**

- UNTIL....GOTO....
- SYMBOLIC OPTIONAL
- LINE NUMBERS

**305 RIVERSIDE DRIVE, NEW YORK, NEW YORK 10025**



# Said the Toolkit to the Word Processor: "You're in My Space!" Said the Word Processor to the Toolkit: "Let's Share...here's

## Socket 2 Me™!"

From the original producer of peripherals exclusively for PET lovers everywhere . . . the device that allows you to select between the BASIC Programmer's Toolkit and the Commodore Word Processor II while they occupy the same address space.

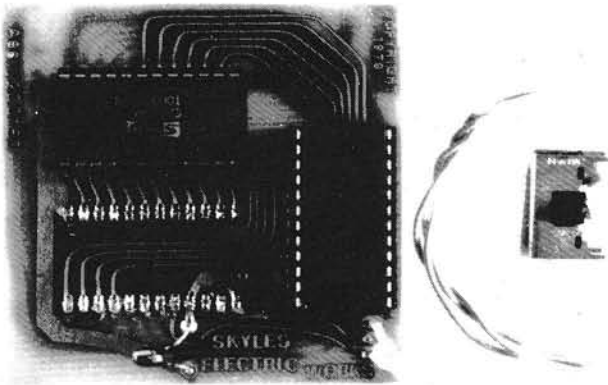

The **Socket 2 ME** . . . doubles your memory expansion in a single socket. It's a 2.5" x 2.75" board that fits neatly into the Toolkit/Word Processor socket on the main logic board of all *new* PETs. Then both the Word Processor and the Toolkit plug into the **Socket 2 ME**.

A miniature slide switch — part of the kit — mounts with double-stick tape (supplied) to the front part of the right side of the PET base, almost hidden by the overhang of the top of the PET cabinet. The slide switch is connected to the **Socket 2 ME** by a special cable (also supplied) . . . and you're up and running.

Up and running; installation took only a minute or so. Flip the switch from Toolkit to Word Processor. And back. No need to open the PET.

Complete with the first-rate installation and operating instructions you've come to expect from all Skyles documentation.

### YOU HAVE AN ORIGINAL 2001-8 PET?

*No problem.* The **Socket 2 ME** interfaces with the BASIC Programmer's Toolkit model TK 160E or TK 160S connector board, the Word Processor II interfaces with the **Socket 2 ME**, the slide switch is placed on the PET base. Then, as long as the PET 2001-8 has at least 8K of memory expansion, the system is up and running.

### YOU HAVE A COMPUTHINK DISK AND YOU WANT A BASIC PROGRAMMER'S TOOLKIT?

*How would you like to switch between the Computhink and the Toolkit with a single SYS command?*

Just add two small jumpers to the Computhink system and a short program to the DOS diskette. Plug in the BASIC Toolkit TK 80E, enter the **SYS** command and your system is up and running.

### NO ROOM ON THE PET 2 COMPUTHINK DISK BOARD?

*All your sockets are booked?* Fret not; Skyles comes to the rescue. **Skyles Electric Works** now has a modified EPROM board available with sockets for the Toolkit and Computhink ROM chips. Plug in the ROMs, add a jumper (supplied) to the PET 2 Computhink disk board, plug the new EPROM board into the Computhink disk board. Power up and enter a short switching program into the DOS diskette. Switch between the Computhink disk and the Toolkit with a single **SYS** command.

### ORDER NOW — with Skyles' 10-day money-back guarantee:

**Socket 2 ME:** \$22.50\*

Commodore Word Processor II: \$100.00\*

Commodore Word Processor III: \$200.00\*

BASIC Programmer's Toolkit

Model TK 80ED \$85.00\*

Model TK 160ED \$95.00\*†

\*Add \$2.50 to each for shipping and handling.

†Note: If Computhink EPROM board is returned, after purchase of TK 160ED, Skyles will refund \$20.00.

"Socket 2 ME" is the trademark of Skyles Electric Works.

California residents: please add 6% or 6.5% sales tax as required

VISA, MASTERCARD ORDERS CALL (800) 538-3083 (except California residents)

CALIFORNIA ORDERS PLEASE CALL (408) 257-9140



# Skyles Electric Works

231 E. South Whisman Road  
Mountain View, CA 94041  
(408) 735-7891



**ALL THE MEMORY AN AIM · SIM · KIM WILL NEED  
EVER!**

16 or 32K RAM Addressable in 4K segments

REGULATORS

Prototyping area with  
separate connector  
space.

8 to 16K EPROM  
[Eprom not included.]

Two 6522  
VIA I/O CHIPS

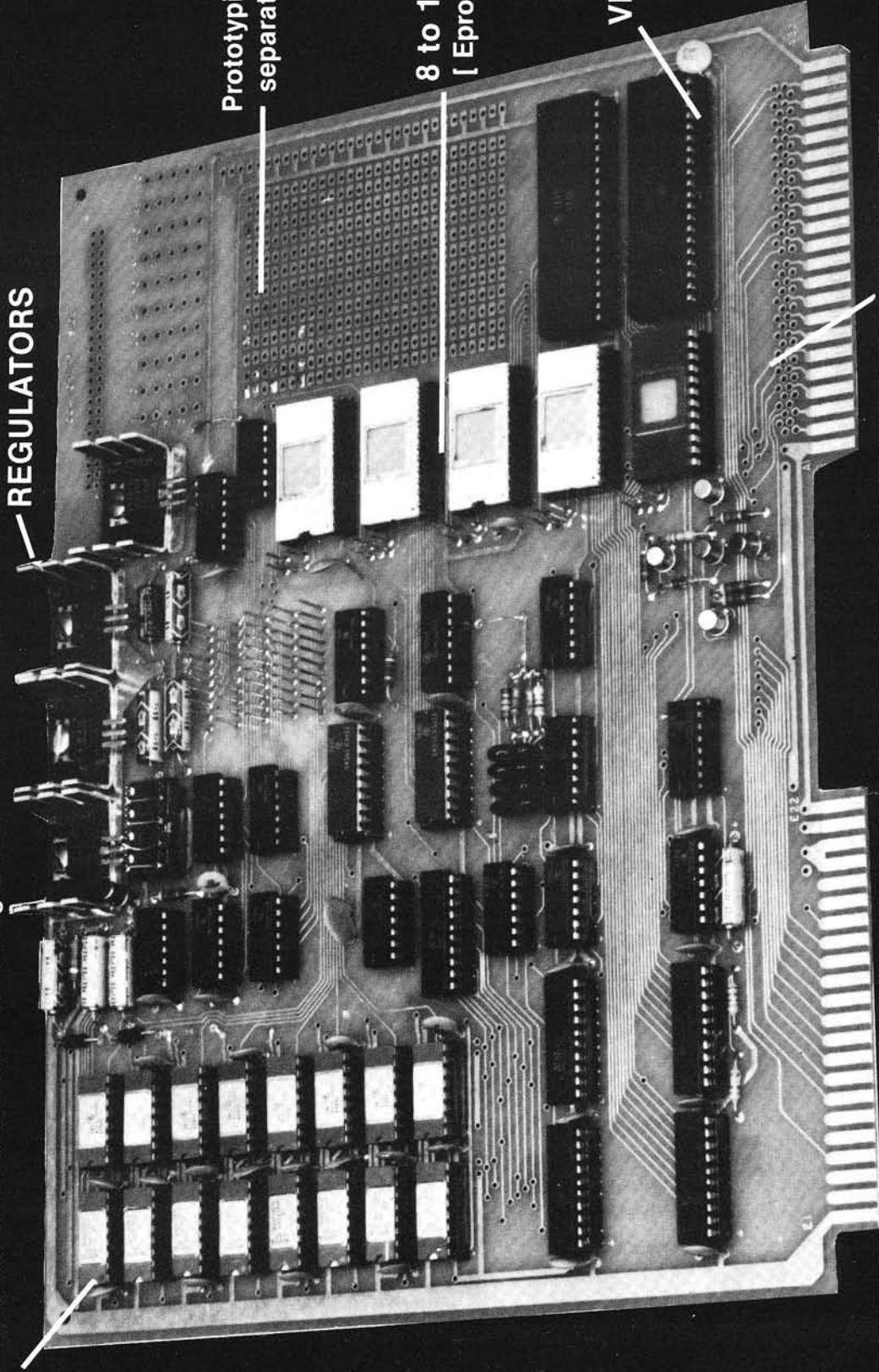

**THE COMPUTERIST, INC.**

P.O. Box 3  
So. Chelmsford, MA 01824  
617/256 - 3649

Write for 1980 catalog.

**EPROM PROGRAMMER**  
[ 2716 or 2732 ]

U.S./Canada  
Price: 16K \$295  
32K \$395

plus shipping  
Foreign prices slightly higher.

**DRAM PLUS™**

## Table of Contents

<b>Editor's Notes</b>	5
<b>APPLE II Floating Point Utility Routines</b> by Harry L. Pruetz	7
<b>A Machine Language Screen Print Program for the Old (or New) PET</b> by Kenneth Finn	13
<b>Polling OSI's Keyboard</b> by Edward H. Carlson	17
<b>A Digital Thermometer for the APPLE II</b> by Carl J. Kershner	21
<b>Challenger II Cassette Techniques</b> by Richard A. Lary	25
<b>Beginning Boolean: A Brief Introduction To Boolean Algebra for Computerists</b> by Marvin L. DeJong	29
<b>Program Checksum Calculator</b> by Nicholas Vrtis	39
<b>Ask the Doctor</b> by Robert M. Tripp	42
<b>Clocking KIM</b> by Ronald A. Guest	45
<b>MICRO Dealers</b>	51
<b>A Home Message Center</b> by William McLean	53
<b>Stop That PET!</b> by Gary Bullard	57
<b>The MICRO Software Catalogue: XVIII</b> by Mike Rowe	63
<b>6502 Bibliography: Part XVIII</b> by William R. Dial	67

## Staff

<b>Editor/Publisher</b> Robert M. Tripp
<b>Associate Editor</b> Mary Ann Curtis
<b>Assistant Editor</b> Evelyn M. Heinrich
<b>Business Manager</b> Maggie E. Fisher
<b>Circulation Manager</b> Carol A. Stark
<b>Art/Advertising Coordinator</b> Terry Spillane
<b>Comptroller</b> Donna M. Tripp
<b>Production Assistant</b> L. Catherine Bland
<b>MICRO Lab</b> R. Keith Beal

MICRO™ is published monthly by MICRO INK, Inc., Chelmsford, MA 01824. Tel. 617/256-5515.  
Second Class postage paid at Chelmsford, Ma 01824.  
Publication Number: COTR 395770.  
Circulation: Paid subscriptions: U.S.: 3800, Foreign: 350; Dealers: U.S.: 4500, Foreign: 1900.  
Subscription rates: U.S.: \$15 per year. Foreign, surface mail: \$18 per year.  
For air mail rate, change of address, back issue or subscription information write to: MICRO, P.O. Box 6502, Chelmsford, MA 01824.  
Entire contents Copyright © 1980 by MICRO INK, Inc.

## Advertiser's Index

AB Computers	33	Micro Technology Unlimited	27,72
Balcan	19	Mighty Byte	19
Beta Computer Devices	66	Muse Software	38
CJM-Industries	41	NIBBLE	24
Classified Ads	9,11,40	Perry Peripherals	50
COMPAS	16	Powersoft, Inc.	4
Computer Applications Tomorrow	66	Programma International	BC
The Computerist, Inc.	2	Progressive Computing	19
Connecticut microComputers	23,50	Progressive Software	49
Decision Systems	66	Rainbow Computing	IBC
Eastern House Software	63	Raygam, Inc.	71
Electronic Specialists, Inc.	33	RNB-Enterprises	36,37
Excert, Inc.	28	Shepardson Microsystems	6
Galaxy	19	SKYLES Electric Works	1,12,56
Hudson Digital Electronics	44	Softside Publications	20
Information Unlimited Software	15	Softside Software	IFC
Instant Software, Inc.	34,35	Stoneware	11
MICRO	50	United Software of America	61

# Software for the Apple II

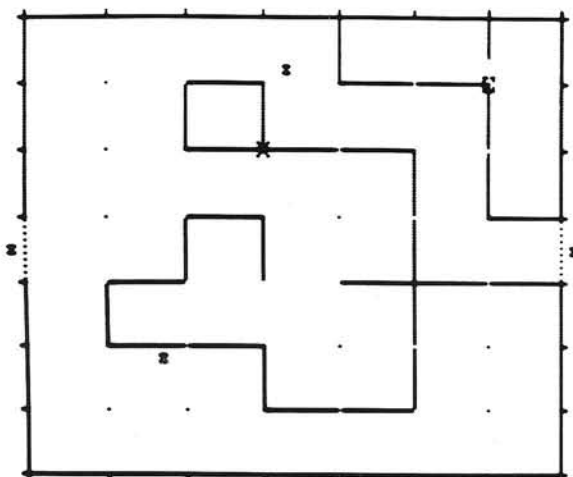

SCORE: 108

SCORE: 105

**DYNAMAZE**—a dazzling new real-time game. You move in a rectangular game grid, drawing or erasing walls to reflect balls into your goal (or to deflect them from your opponent's goal). Every ball in your goal is worth 100 points, but you lose a point for each unit of elapsed time and another point for each time unit you are moving. Control the speed with a game paddle: play as fast as ice hockey or as slowly and carefully as chess. Back up and replay any time you want to; it's a reversible game. By Don Stone. Integer Basic (plus machine language); 32 K; \$9.95.

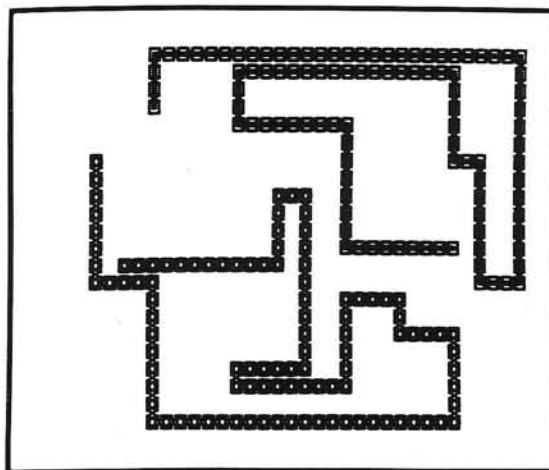

**ULTRA BLOCKADE**— the standard against which other versions have to be compared. Enjoy Blockade's superb combination of fast action (don't be the one who crashes) and strategy (the key is accessible open space—maximize yours while minimizing your opponent's). Play against another person or the computer. New high resolution graphics lets you see how you filled in an area—or use reversibility to review a game in slow motion (or at top speed, if that's your style). This is a game that you won't soon get bored with! By Don Stone. Integer Basic (plus machine language); 32 K; \$9.95.

What is a **REVERSIBLE GAME**? You can stop the play at any point, back up and then do an "instant replay", analyzing your strategy. Or back up and resume the game at an earlier point, trying out a different strategy. Reversibility makes learning a challenging new game more fun. And helps you become a skilled player sooner.

**WORLD OF ODYSSEY**—a new adventure game utilizing the full power of Disk II, which enables the player to explore 353 rooms on 6 different levels full of dragons, dwarfs, orcs, goblins, gold and jewels. Applesoft II 48K; \$19.95 includes diskette.

**PERQUACKEY**—an exciting vocabulary game which pits the player against the clock. The object of the game is to form words from a group of 10 letters which the computer chooses at random. The words must be 3 to 10 characters in length with no more than 5 words of any particular length. Each player has only 3 minutes per turn. The larger the words the higher the score. Applesoft II 16K; \$9.95.

**APPLESHIP**—is a naval game in which two players enter their ships in respective oceans. Players take turns trying to blast their opponent's ships out of the water. The first player to destroy their opponent's ships may win the game. A great low-res graphics game. Applesoft II 32K; \$14.95.

Available at your  
local computer store

Call or write for our free  
SOFTWARE CATALOG

Apple II is a registered  
trademark of  
Apple Computer, Inc.

DEALER INQUIRIES INVITED

**POWERSOFT, INC.**

P. O. BOX 157  
PITMAN, NEW JERSEY 08071  
(609) 589-5500

Programs Available on Diskette  
at \$5.00 Additional

- Check or Money Order
- Include \$1.00 for shipping and handling
- C.O.D. (\$1.00 add'l. charge)
- Master Charge and VISA orders accepted
- New Jersey residents add 5% sales tax

## A 16 Bit 6502?

Several microprocessor manufacturers who make 8 bit micros have recently come out with 16 bit versions or variations. Some of these are true 16 bit micros and some might be best termed "pseudo" 16 bit, that is micros that are basically 8 bit and have an 8 bit data bus, but which can perform some 16 bit operations. There has been talk from time to time about a pseudo 16 bit version of the 6502. It has even had a number, 6509 or 6516, but at present it looks as though it is only a designer's dream.

If someone were to come up with a pseudo 16 bit version of the 6502, what should it contain? And, is there really a need for such a device? I have a few ideas on these matters which I will present next month. An article by Randall Hyde will describe in detail the specifications which were generated for a Synertek 6516. Between now and

then, why don't you think about these topics and see what you would like to have in a 16 bit version of the 6502? Maybe with enough input from various sources we can help get such a project moving.

### A MICROscope Note

If you have applied to be a reviewer for the **MICROscope** product review, thank you. We will be sending out acknowledgements and additional information this month. A number of products have been submitted for review, so we will be getting these out to the reviewers soon, and the first **MICROscope** should appear within a couple of months. If you have a product to be reviewed: hardware, software, book, or whatever, contact us for the proper forms.

*Robert M. Tripp*

Statement of Ownership, Management, etc., required by the act of Congress of October 23, 1962 of **MICRO** published monthly at Chelmsford, Massachusetts for March 1980.

The name and address of the publisher is **MICRO INK, Inc.**, 34 Chelmsford Street, Chelmsford, Massachusetts. The Editor/Publisher is Robert M. Tripp of Chelmsford, Mass.

The owner is **MICRO INK, Inc.**, Chelmsford, Mass. and the name and address of stockholders owning or holding one percent or more of the total amount of stock is: Robert M. Tripp and Donna M. Tripp of Chelmsford, Mass.

The known bondholders, mortgagees and other security holders owning one percent or more of the total amount of bonds, mortgages or other securities are: none.

The average number of copies of each issue of this publication sold or distributed through the mails or otherwise to paid subscribers during the twelve months preceding the date shown above is: 7063.

I certify that the statements made by me above are correct and complete.

Signed: Robert M. Tripp  
Editor/Publisher



PO Box 6502  
Chelmsford, Mass 01824  
617-256-5515

"The BEST of MICRO Volume 1" contains all of the important material from the first six issues of **MICRO** in book form.

"The BEST of MICRO Volume 2" contains all of the important material from the second six issues [#7 to 12] of **MICRO** in book form.

Back Issues:

Issues 7 to 12: .....  
Issues 13 on: .....

All payments must be in US dollars.  
Make checks payable to: **MICRO**  
Foreign payments in International Money Order or cash.

If you are a subscriber, attach label or write subscription number here: .....

Name: .....

Address: .....

City: ..... State: ..... Zip: .....

Country (if not U.S.): .....

Help **MICRO** bring you the info you want by completing this short questionnaire.

Microcomputers Owned/Planning to Buy: AIM SYM KIM PET APPLE OSI Other: .....

Peripherals Owned/Planning to Buy: Memory Disk Video Printer Terminal Other: .....

Microcomputer Usage: Educational Business Personal Control Games Other: .....

Languages Used: Assembler BASIC FORTH PASCAL Other: .....

Your comments and suggestions on **MICRO**: .....

Subscription: One Year = 12 issues. Circle correct category and write amount in space provided.

Surface:

United States \$15.00  
All Other Countries \$18.00

Air Mail:

Central America \$27.00  
Europe/So. America \$33.00  
All Other Countries \$39.00 \$ .....

"BEST of MICRO Volume 1"

Surface \$7.00  
Air Mail \$10.00 \$ .....

"BEST of MICRO Volume 2"

Surface \$9.00  
Air Mail \$13.00 \$ .....

No. Surface @ \$1.75 each = \$ .....

No. Air Mail @ \$2.75 each = \$ .....

No. Surface @ \$2.25 each = \$ .....

No. Air Mail @ \$3.25 each = \$ .....

TOTAL \$ .....

Announcing...

## OPTIMIZED SYSTEMS SOFTWARE

### UPGRADE YOUR APPLE II<sup>®</sup> WITH A NEW SYSTEMS SOFTWARE PACKAGE

- Unified Operating System
- Disk File Manager
- Commercial Basic
- Editor/Assembler/Debugger
- Data Base Manager

Optimized Systems Software does not use Apple DOS<sup>®</sup>. OSS is a unified and complete systems software package with its own Operating System and File Manager. The Operating System, the File Manager and the Basic combined use only slightly more RAM than Apple DOS<sup>®</sup> alone. Requires 48K Apple II<sup>®</sup> with Disk II.

#### Operating System

- Byte and Block I/O
- Simple User Interface
- Simple Device Interface  
(create your own)

#### Basic

- Nine Digit Precision DECIMAL Floating Point
- 32K Byte Strings
- Variable Names to 256 significant characters
- I/O Interface Statements  
(no PRINT "control-D...")

#### File Manager

- Open, Read, Write, Delete, Lock, etc.
- Random Access via Note & Point
- File Names of Primary.Ext type

#### Editor/Assembler/Debugger

- Line Editor  
(Edits Basic programs, too)
- Mini Assembler
- Maxi Assembler
- Disassembler
- Step, Trace, etc.

#### Available NOW at Special Introductory Prices

- |   |         |
|---|---------|
| ● Operating System + File Manager               | \$24.95 |
| ● Operating System + File Manager + Basic       | \$49.95 |
| ● Operating System + File Manager + ASM         | \$49.95 |
| ● Operating System + File Manager + Basic + ASM | \$89.95 |
| ● Operating System + Data Base Manager          | (2nd Q) |

Order today. Add \$2.00 for shipping & handling. California residents add 6% sales tax. Visa/Mastercharge welcome. Personal checks require 2 weeks to clear.

Note: Apple II<sup>®</sup>, Apple DOS<sup>®</sup> are trademarks of Apple Computer, Inc.

Optimized Systems Software  
Shepardson Microsystems, Inc.  
20823 Stevens Creek Blvd., Bldg. C4-H  
Cupertino, CA 95014  
(408) 257-9900



# APPLE II Floating Point Utility Routines

Here is a guide to the Applesoft BASIC floating point utility routines which will permit them to be used effectively from assembly language programs. Get the best of both worlds: optimize your programs by writing them in assembly, and, use these excellent floating point math routines directly.

Harry L. Pruetz  
2213A Lanier Drive  
Austin, TX 78758

Although floating point capabilities are available in Applesoft BASIC, it is still useful to do floating point operations from machine language. This is especially true when the floating point operations are needed at some point in a machine language routine and it would be very tedious to pass parameters back up to a FP BASIC program. The alternative of writing special machine language routines for the solution of a few calculations can also delay a programming project unnecessarily. The purpose of this article is to give an idea of how the AFPUR (Apple Floating Point Utility Routines) work and how to use them.

AFPUR uses 248 bytes from \$F425 to \$F4FB and the FIX and underflow routines from \$F63D to \$F65D. In case of overflow, a jump to OVLOC (\$3F5) is taken, where a jump to your own code should be stored. Floating Point work space is given in the reference manual as \$F0 to \$FF although only \$F3 to \$FF are used. The floating point work space bytes and their uses are given in Table 1

E is an extra copy of the FPI mantissa saved during all arithmetic operations although it is actually used only in division. EG is an extra byte changed by the align and normalize code when FP1 and FP2 are being shifted. FP = X,H,M,L is the floating point format of a number where X is the exponent and H, M, and L are the high, medium, and low bytes of the mantissa. Note that the order of the bytes according to significance is opposite that in Integer and FP BASIC and the Sweet 16 interpreter.

The floating point format is similar to 32-bit hardware on many larger computers. The exponent is excess 128 so that \$80 represents  $2^0$ . The mantissa is two complement normalized until the two leading bits are different so that  $+1.0 = \$80\ 40\ 00\ 00$  and  $-1.0 = \$7F\ 80\ 00\ 00$ . Here are some more examples of decimal numbers in hex floating point format:

```
0.0 = $00 00 00 00
1.5 = $80 60 00 00
1.75 = $80 70 00 00
10.0 = $83 40 00 00
256.0 = $88 40 00 00
0.1 = $7C 66 66 66
```

Note that the floating point form \$7C 66 66 66 is a truncated approximation of 0.1 so that 0.1 multiplied by 10.0 will give \$7F 7F FF FE instead of \$80 40 00 00. The AFPUR will work on unnormalized numbers although there can be a loss of accuracy because of the way the alignment code works. For example, in adding the numbers \$7F 80 00 00 and \$69 40 00 00, the result is \$7F 80 00 00 + \$7F 00 00 01 = \$7F 80 00 01. Using the unnormalized \$80 C0 00 00 would give \$80 C0 00 00 + \$80 00 00 00 = \$7F 80 00 00. These cases give trivial losses of accuracy, but more extreme cases can make your Apple II seem like it can't add. Since results of arithmetic operations are normalized in all cases, unnormalized numbers can only be input to the AFPUR by the programmer in the form of stored constants.

Table 2 gives a general idea of how the AFPUR works.

Trying to POKE or PEEK from Integer BASIC will not work because critical information is stored in the same locations as the floating point work space. For example, \$F6 and \$F7 contain the current Integer BASIC line number and \$F8 contains the automatic line numbering mode flag. If a machine language routine is called from Integer BASIC and AFPUR routines are used, then location \$F8 should be set to 0 before returning to the Integer BASIC program.

In the following examples of calls to AFPUR, FP1 and FP2 are used as the 4-byte FP registers at \$F8 and \$F4. If you can try the monitor calls on your Apple II, the examples will be more instructive.

FCOMPL is called by FSUB one time, FMUL two or three times, and FDIV two or three times. It may be called directly by the user. The only FP number which can cause an overflow error is \$FF 80 00 00. FCOMPL is easy to use from the monitor:

```
*F8:80 60 00 00
*F8.FB F4A4G F8.FB.
```

An example of a call to give  $A = -A$  can be coded by the steps:

```
*0) Declare hex storage as a hex string
A .HS 00000000
*1) Load FP1 with A
LDX #3
LDAL LDA A,X
STA FP1,X
DEX
BPL LDAL
```

\*2) Floating complement the number

```

JSR $F4A4 FCOMPL
*3) Store FP1 in A
LDX #3
STAL LDA FP1, x
STA A,X
DEX
BPL STAL

```

FLOAT of a fixed point number assumes a 15-bit signed integer in M1H and M1M and an 8-bit fraction in M1L. If no fraction is intended, then M1L must be set to \$00. FLOAT is a special entry point preceding normalization code and is called no other place in APFUR. FLOAT is solely for the user. Because of the 15-bit limit on the magnitude of the integer, there can be no overflow errors.

An example of using FLOAT from the monitor is:

```

*F9:00 64 00
*F8. FB F451G F8.FB.

```

An example of a call to give FPA = float (IA) can be coded by the steps:

```

*0) Declare hex strings for IA and FPA
IA .HS 0000
FPA .HS 00000000
*1) Load IA into M1
LDA IA + 1 Intg high byte
STA M1H
LDA IA Intg low byte
STA M1M
LDA #0
STA M1L
*2) Float the integer
JSR $F451 FLOAT
*3) Store FP1 into FPA
LDX #3
STAL LDA FP1, X
STA FPA, X
DEX
BPL STAL

```

The FIX of an FP number returns a 15-bit signed integer in M1H and M1M and an 8-bit fraction in M1L. Depending on the size of the FP number, EH, EM and EL may also contain parts of a frac-

tion which could be useful in some calculation. In the more typical uses of FIX, only M1H and M1M are of practical use. FIX has a flaw in the way it treats negative numbers. The FIX1 (\$F63D) entry point must be used for negative FP numbers. Calling FIX for FP numbers with exponents larger than \$8E will cause overflow errors. Calling FIX1 for negative FP numbers with \$8E 7F FF 00, \$8E 80 00 00, or exponents larger than \$8E will cause overflow errors. To insure that the overflow routine given later in this article will operate properly, a CLV should precede all FIX and FIX1 calls. Some examples of fixing FP numbers from the Monitor are:

```

*F8:7F 80 00 00
*F8.FB F63DG F8.FB
*F8:80 7F FF 00
*F8.FB F640G F8.FB

```

An example of using an intermediate routine UFIX to give IA = fix(FPA) is:

```

*0) Declare hex strings for IA and FPA
IA .HS 0000
FPA .hs 00000000
*1) General UFIX routine
UFIX CLV FOR
OVERFLOW PROCESS-
ING
LDA M1H GET SIGN OF
FP1
BPL UFIM
JSR $F68D FIX1
(NEGATIVE FP1)
RTS
UFIM JSR $F640 FIX
(PPOSITIVE FP1)
RTS
*2) Load FPA into FP1
LDX #3
LDAL LDA FPA, X
STA FP1, X
DEX
BPL LDAL
*3) Fix the FP number
JSR UFIX
*4) Store M1 into IA, reversing

```

byte order

```

LDA M1M
STA IA
LDA M1H
STA IA + 1

```

Unfortunately, FP2 is sometimes changed depending on the signs and exponents of FP1 and FP2 in routines FADD, FSUB, FMUL, and FDIV. Thus, if FP2 is a constant being used in a series of calculations, it would be wise to restore FP2 each time.

An overflow error can occur in the FSUB call to FCOMPL. FP1 can be corrected and control returned to FSUB. FADD and FSUB may both have overflow errors after the operation is completed and normalization is being done. FP2 and FP1 are swapped (interchanged) if FP1 has the larger exponent since alignment operates by shifting the mantissa of FP1 right until the exponents X1 and X2 are equal.

An example of using FADD and FSUB from the monitor is:

```

*F4:81 40 00 00 80 40 00 00
*F0.FF F46EG F0.FF
*F4:81 40 00 00 80 40 00 00
*F0.FF F468G F0.FF

```

FMUL and FDIV both call FCOMPL to get the absolute value of the operand in FP1. This is done by swapping FP1 and FP2, taking the absolute value of FP1, swapping FP1 and FP2 again, and taking the absolute value of FP1 again. The sign of the result (product or quotient) is stored at location \$F3 in the right-most bit. Before returning to the user's program, the sign is tested and FCOMPL is called if bit 0 of SIGN is set. An overflow error can occur on any of these FCOMPL calls if FP1 is \$FF 80 00 00. Both FMUL and FDIV check for overflow and underflow when calculating the exponent of the unnormalized result. Underflow is handled by UNDFL at \$F657 and overflow by the user's own routine.

Table 1

ADDR	NAME	USE
\$F3	SIGN	Product/Quotient sign
\$F4	X2	FP2 exponent
\$F5	M2H	FP2 mantissa high byte
\$F6	M2M	FP2 mantissa medium byte
\$F7	M2L	FP2 mantissa low byte
\$F8	X1	FP1 exponent
\$F9	M1H	FP1 mantissa high byte
\$FA	M1M	FP1 mantissa medium byte
\$FB	M1L	FP1 mantissa low byte
\$FC	EH	M1H copy
\$FD	EM	M1M copy
\$FE	EL	M1L copy
\$FF	EG	garbage

Table 2

ADDR	ROUTINE	OPERATION	TIME
\$F46E	FADD	FP1 = FP2 + FP1	1.5 millisecond
\$F468	FSUB	FP1 = FP2 - FP1	1.6 millisecond
\$F48C	FMUL	FP1 = FP2 * FP1	3.5 millisecond
\$F4B2	FDIV	FP1 = FP2 / FP1	5.6 millisecond
\$F451	FLOAT	FP1 = float(M1)	105 microsecond
\$F640	FIX	M1 = fix(FP1)	125 microsecond
\$F4A4	FCOMPL	FP1 = - FP1	135 microsecond

FP constants may be calculated by using the monitor as in finding 29.43. The steps are:

- 1) load M1M with 43 = \$2B
  - 2) float
  - 3) move FP1 to FP2
  - 4) load M1M with 100 = \$64
  - 5) float
  - 6) divide giving FP1 = float (43)/float (100)
  - 7) move FP1 to FP2
  - 8) load M1M with 29 = \$1C
  - 9) float
  - 10) add giving FP1 = 29.43
- \*F8:00 00 2B 00 F8.FF  
 \*F451G F4 F8.FBM F0.FF  
 \*F8:00 00 64 00 F8.FF  
 \*F451G F4B2G F4 F8.FBM F0.FF  
 \*F8:00 00 1C 00 F8.FF  
 \*F451G F46EG F0.FF

The final result is FP1 = \$84 71 B8 51 or 29.43.

As is obvious to the most casual observer, calculating very many constants using the monitor is hazardous to your enthusiasm.

The order in which operands are loaded in FP1 and FP2 for addition and multiplication can be chosen so that the user's code is more efficient. For example, the statement  $D = A * B + C$  can be coded by the steps:

- \*0) Declare hex strings for A,B,C,D
- A .HS 80 60 00 00 1.5  
 B .HS 82 40 00 00 4.0  
 C .HS 7F 80 00 00 -1.0  
 D .HS 00 00 00 00
- \*1) Load FP1 with A
- ```
LDAL LDX #3
      LDA A,X
      STA FP1,X
      DEX
      BPL LDAL
```
- \*2) Load FP2 with B
- ```
LDBL LDA #3
      LDA B,X
      STA FP2,X
      DEX
      BPL LDBL
```
- \*3) Multiply with product left in FP1
- ```
JSR $F48C
```
- \*4) Load FP2 with C
- ```
LDCL LDX #3
      LDA C,X
      STA FP2,X
      DEX
      BPL LDCL
```
- \*5) Add with sum left in FP1
- ```
JSR $F46E
```
- \*6) Store answer in D
- ```
STD LDX #3
      LDA FP1,X
      STA D,X
      DEX
      BPL STD L
```

The statement  $D = A/B - C$  can be coded by the steps:

- \*7) Load FP2 with A and FP1 with B
- ```
LDX #3
LABL LDA A,X
      STA FP2,X
      LDA B,X
      STA FP1,X
      DEX
      BPL LABL
```
- \*8) Divide leaving the result in FP1
- ```
JSR $F4B2
```
- \*9) Move FP1 to FP2 and load FP1 with C
- ```
LDX #3
LDCL LDA FP1,X
      STA FP2,X
      LDA C,X
      STA FP1,X
      DEX
      BPL LDCL
```
- \*10) Subtract leaving the difference in FP1
- ```
JSR $F468
```
- \*11) Store the answer in D
- ```
LDX #3
STD L LDA FP1,X
      STA D,X
      DEX
      BPL STD L
```

All of the overflow errors detected in the AFPUR jump to OVLOC and then to the user's code. When CLV is used before fixing a FP number, the status register bits N,V,Z can be used to determine the routine where the error occurred. Table 3 demonstrates this.

Table 3

| Routine | N | V | Z | EOR Test | STK |
|---------|---|---|---|----------|-----|
| FIX     | 0 | 0 | 1 | \$02     | 0   |
| FIXL    | 0 | 0 | 1 | \$02     | 0   |
| FCOMPL  | 0 | 1 | 1 | \$42     | 0   |
| FADD    | 0 | 1 | 1 | \$42     | 0   |
| FSUB    | 0 | 1 | 1 | \$42     | 0   |
| FMUL    | 1 | 0 | 0 | \$80     | 2   |
| FDIV    | 1 | 0 | 0 | \$80     | 2   |

The routine in Listing 1 determines which minimum or maximum integer or FP number to store in FP1 before returning to the AFPUR. The contents of the status register and the AFPUR return address are stored in locations \$F0, \$F1, \$F2.

The times for the AFPUR given at the first of this article are for the routines themselves. As can be seen by the previous examples, much more code is required to make practical use of the AFPUR. Two fairly simple programs were used to time the AFPUR. The program used to time FADD consisted of summing the floated values of the integers 1 to 32,768. The program required about 55 seconds to get \$9C 7F 64 00, which is close to  $5.37 * 10^8$ . Part of the

time was spent in the FLOAT routine and the summing program itself. A listing of the program is given in Listing 2.

The relative offsets of labels from SUM1 are ZL = \$04, INC2 = \$0A, FLT = \$2D, SL = \$3E and IH = \$49.

The program used to time FMUL consisted of summing a geometric progression with a factor close to 1.0. The multiplications involved calculating the next term in the sequence. For a factor too close to 1.0, the loss of accuracy in the floating point operations gave an incorrect answer. However, for factors like \$80 3F FF F0, the answer was close enough. A listing of the program for finding  $(1 - R^N)/(1 - R) = 1 + R + \dots + R^N$  is given in Listing 3.

The code in the AFPUR demonstrates many useful machine language programming tricks. I also think too much speed was sacrificed to get a minimum amount of code. Although the floating point format used is fairly standard, the methods used would work better with a signed magnitude floating point format so that negative operands could be easily complemented before multiplication or division.

Finally, a 3-byte floating point format would be entirely sufficient such that integers and FP numbers had the same byte order for many machine language programming applications.

## Classified Ads

For the SERIOUS APPLE II User  
 Quality Software in machine code:  
 Video/Print/List Controller—Word  
 Processor & Text Editor—Catalog  
 Sorter & Alphabetizer—And in Applesoft: 1979 Income Tax.  
 Howard Software Services  
 7722 Hosford Ave., Dpt. M  
 Los Angeles, CA 90045

FOR SALE: APPLE II COMPUTER,  
 new, 2 disks, 2 printers, Pascal  
 Language Board, CRT monitor,  
 D.C. Hayes Modem, Interface Bd.,  
 clock calendar card, joysticks, Apple  
 word processor. Sell all or part,  
 good price.

Don  
 (714) 776-6384, California

### Listing 1

```

*          OVFL
*AFPUR OVERFLOW ROUTINE
*
      .OR $3F5
      JMP OVFL
      .OR $900
SIGN  .EQ $F3
FP1   .EQ $F8
OVFL  PHP      SAVE STATUS
      PLA
      AND #$C2
      STA $F0  STORE STATUS
      PHA
      EOR #$80
      BEQ MLDV MULTIPLY/DIVIDE
      PLA
      EOR #$42
      BEQ ADSB ADD/SUBTRACT
*FIX  OVERFLOW--SIGN BIT IN C
      BCS FIXM
      LDX #3   INTEGER MINIMUM
      BPL OVST
FIXM  LDX #7   INTEGER MAXIMUM
      BPL OVST
*MULTIPLY/DIVIDE OVERFLOW--SIGN BIT IN SIGN
MLDV  FOR SIGN
      PLA      ADJUST STACK
      PLA
*ADD/SUBTRACT OVERFLOW--SIGN BIT IN C
ADSB  BCS ASM
      LDX #11  FP MINIMUM
      BPL OVST
ASM   LDX #15  FP MAXIMUM
*STORE OVERFLOW VALUE IN FP1 FOR ALL CASES
OVST  LDY #3
OVSL  LDA OTBL,Y
      STA FP1,Y
      DEX
      DEY
      BPL OVSL
*SAVE AFPUR RETURN ADDRESS
      CLV      CLEAR V STATUS BIT
      PLA
      STA $F1
      INC 1F1
      PLA
      STA $F2
      JMP ($F1)
OTBL  .HS 8E7FFF00
      .HS 8E800100
      .HS FF7FFFFF
      .HS FF800001

```

### Listing 2

```

*          SUMI
*SUM INTEGERS PROGRAM
*
      FP1 .EQ $F8
      FP2 .EQ $F4
      M1  .EQ $F9
SUMI  LDX #6   ZERO IH THROUGH S
      LDA #0
ZL    STA IH,X
      DEX
      BPL ZL

```

```

INC2  INC IM   INCREMENT IM AND IH
      BNE FLT
      INC IH   INCREMENT IH EVERY 256 ITERATIONS
      LDA IH
      CMP #$80
      BNE INC2
      RTS
*LOAD INTEGER INTO M1
FLT   LDA IH
      STA M1
      LDA IL
      STA M1+1
      LDA #0
      STA M1+2
      JSR $F451 FLOAT
      LDX #3   ADD INTEGER TO SUM
AL    LDA FP1,X
      STA FP2,X FP2=FP1
      LDA S,X
      STA FP1,X FP1=S
      DEX
      BPL AL
      JSR $F46E FADD
      LDX #3   SAVE SUM
SL    LDA FP1,X
      STA S,X  S=FP1
      DEX
      BPL SL
      JMP INC2
IH    .DA #0   INTEGER HIGH BYTE
IM    .DA #0   INTEGER MIDDLE BYTE
IL    .DA #0   INTEGER LOW BYTE
S     .HS 00000000 SUM

```

### Listing 3

```

          GSUM
*GEOMETRIC PROGRESSION SUM
*
FP1     .EQ $F8
FP2     .EQ $F4
      .OR $800
GSUM    LDX #6   ZERO I AND S
      LDA #0
ZL      STA IH,X
      DEX
      BPL ZL
*SET T = 1.0
      LDA #$40
      STA T
      LDA #$40
      STA T+1
      LDA #0
      STA T+2
      STA T+3
*ST R = 1.0 - 2 (-18)
      LDA #$80
      STA R
      LDA #$3F
      STA R+1
      LDA #$FF
      STA R+2
      LDA #$F0
      STA R+3
*INCREMENT IM AND IH
INC2  INC IM
      BNE CALC
      INC IH
      LDA IH
      CMP #$80

```

```

BNE INC2
RTS
*LOAD S AND T FOR ADD
CALC LDX #3
AL LDA S,X
STA FP1,X FP1=S
LDA T,X
STA FP2,X FP2=T
DEX
BPL AL
JSR $F46E FADD S+T
*SAVE S
LDX #3
SL LDA FP1,X
STA S,X
DEX
BPL SL
*LOAD T AND R FOR MULT
LDX#3
ML LDA T,X
STA FP1,X FP1=T
LDA R,X
STA FP2,X FP2=R
DEX
BPL ML
JSR $F48C FMUL R*T
*SAVE T
LDX #3
TL LDA FP1,X
STA T,X
DEX
BPL TL
JMP INC2
IH .DA #0 LOOP INDEX HIGH
IM .DA #0 LOOP INDEX MIDDLE
S .HS 00000000SUM
T .HS 00000000TERM
R .HS 00000000FACTOR

```

A JSR FDIV was substituted in this program to get the FDIV timing.

## Classified Ads

**TEXTPRO:** Hardware, Firmware and powerful Software. Apple II plug-in addition for (1) Text editing, (2) Screen editing, (3) programming Upper/Lower case, Powerful Supermon-3 2716 EPROM Monitor I.C. Complete: 45 page documentation, text-processing software (disk) and all hardware. 15-minute installation. Call collect for information. \$349.

TextPro Corporation  
1367 Post St. Studio 19  
San Francisco, Ca 94109  
(415) 775-5708

**PET MACHINE LANGUAGE GUIDE:** Comprehensive manual to aid the machine language programmer. More than 30 routines are fully detailed so that the reader can put them to immediate use. For either Old or New ROMs. \$6.95 plus .75 postage. VISA or MasterCard accepted. Order from:

Abacus Software  
P.O. Box 7211  
Grand Rapids, MI 49510

**ASTROsoft presents:** Solar System Simulator: graphic display of planets orbiting Sun for any range

of dates. Requires Applesoft 32K, HIRES character generator in APPLE II contributing pages, Volume 3. Specify RAM or ROM Applesoft, mem. size, I/O. Tape \$15. Disk \$30. Check or MO to:

William Judd  
701 South 22nd Street  
Omaha, NE 68102  
Soon, Star Map, Life of Sun.

**AIM 65 Newsletter**  
six bimonthly issues for \$5.00 in U.S. and Can. (\$12.00 elsewhere).

The Target, c/o Donald Clem  
RR number 2  
Spencerville, OH 45887

**CHALLENGER 1P OWNERS:** Tired of 24X24 graphics? \$40 worth of components will upgrade your video display to give 30 lines X 50 characters on screen and double your processor speed. Complete software and step by step hardware modifications for only \$8.00. Contact:

S. Chalfin  
905 Clinton St.  
Philadelphia, PA 19107

# STONEWARE for APPLE II\*

## For the Serious Business or Home User: MICRO MEMO

MICRO MEMO is the first sophisticated "Desk Calendar" program to make good use of your computer's power.

- \* Micro Memo includes one time, weekly, monthly, semi-annual and annual reminders.
- \* Monthly reminders may be for fixed or "floating" dates (ex. 1st Saturday of every month).
- \* Each reminder allows choice of one week, 2 week or 1 month advance notice—reminds you ahead of time to prepare for meetings, purchase tickets, make reservations, etc.
- \* Micro Memo includes "shorthand" for fast memo entry, greater capacity.
- \* Micro Memo will display or print any day's or week's reminders.
- \* Micro Memo is a "perpetual" calendar—automatically creates new months with all appropriate memos (birthdays, anniversaries, monthly meetings, etc.) as past months are dropped—system holds full year's reminders on one disk.
- \* Micro Memo "knows" most major holidays.
- \* Supports Mountain Hardware clock (optional).
- \* "Bomb Proof" menu driven command and data entry.
- \* Requires 48K, disk, RAM or ROM Applesoft.

**\$39<sup>95</sup>**

**STONEWARE**  
Microcomputer Software  
P.O. Box 7218, Berkeley, CA 94707  
(415) 548-3763

## And Just for Fun: TRANQUILITY BASE



TRANQUILITY BASE is a fast high resolution Lunar Lander game by Bill Budge, creator of Apple's "Penny Arcade." TRANQUILITY BASE is just like the popular arcade game, including multiple moonscapes, craft rotation, and zoom in for a close-up view as you approach the Lunar surface.

TRANQUILITY BASE requires 32K and disk.

Available at your favorite computer store or direct from STONEWARE (add \$2 shipping & handling; Calif. residents add sales tax. Visa & MasterCard accepted, no C.O.D.'s).

DEALER INQUIRIES INVITED

\*Apple II is a Trademark of Apple Computer, Inc.



# Skyles Electric Works

## Old PET or New PET... Expand Its User Memory Now!

...up to 40K with the precision made Skyles Memory Systems

The printed circuit board adapter connects directly to the data bus on your PET, with ribbon cable and 50 pin connector that keeps the data bus open to the outside world. Installs in minutes without special tools or equipment...you need just an ordinary screwdriver.

Three Skyles Memory Expansion Systems to choose from: 8K, 16K, 24K...allowing the 2001-8 to be expanded to 32K, the new 8N also to 32K, the new 16N/32N and 16B/32B PETs to 40K. You can, *at any time*, increase your PET's memory by 8 kilobyte increments up to the limits indicated. Let your PET's user memory grow on you, 8K at a time.

Each System now comes complete with a test cassette--at no extra cost--for testing high speed read-write and low speed memory retention.

At the great prices you should always expect from Skyles:

|                                                          |           |
|----------------------------------------------------------|-----------|
| 8KM 8K Memory Expansion Board                            | \$200.00* |
| 16KM 16K Memory Expansion Board                          | 400.00*   |
| 24KM 24K Memory Expansion Board                          | 600.00*   |
| PMA-8 Memory Adapter for 2001-8                          | 50.00*    |
| PMA-16 Memory Adapter for 8N and 8B, 16N/32N and 16B/32B | 50.00*    |

**Note: All Memory Expansion Boards require a Memory Adapter.**

**We're so sure of ourselves,  
we're guaranteeing  
all complete Skyles  
Memory Expansion  
Systems for a period  
of 16 months!**

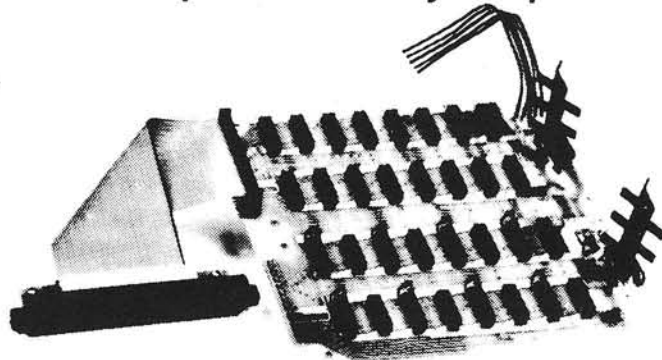

*\*California residents: please add 6% or 6.5% sales tax as required.*

VISA, MASTERCHARGE ORDERS CALL (800) 538-3083 (except California residents)  
CALIFORNIA ORDERS PLEASE CALL (408) 257-9140



# Skyles Electric Works

231 E South Whisman Road  
Mountain View, CA 94041  
(408) 735-7891

# A Machine Language Screen Print Program- for the Old (or New) PET

A program is presented which gives the user control over printing from the old PET screen. The commented assembly language program provides information on printing and can be used as a starting point for other print utilities.

Kenneth Finn  
Little Old Farm  
Bedford, NY 10506

After waiting almost a year, I finally received the dot matrix, friction feed printer for the Commodore PET. The printer plugs right into the IEEE port and will print all the PET graphics as well as upper and lower case letters.

When I received the printer, I also got some very scanty documentation. What I learned from it is that you can print in your programs by using PRINT# statements after OPEN-ing the file. I also learned that you could set up the printer as the primary device by using the following code:

```
OPEN 4,4,0 : CMD 4
```

This is fine to have the printer print *everything* that would be on the screen but still not very good if you just want to print *some* things.

What I needed was a short program that would print what was on the screen when I wanted it printed. This dictated a machine language program stored in the second cassette buffer that I could call with a SYS826 when I wanted anything printed. After some trepidation and a lot of help from other programs, the following is the result. It can reside in the second cassette buffer and will print the *top 22 lines* of the screen at *40 characters per line* when you want it.

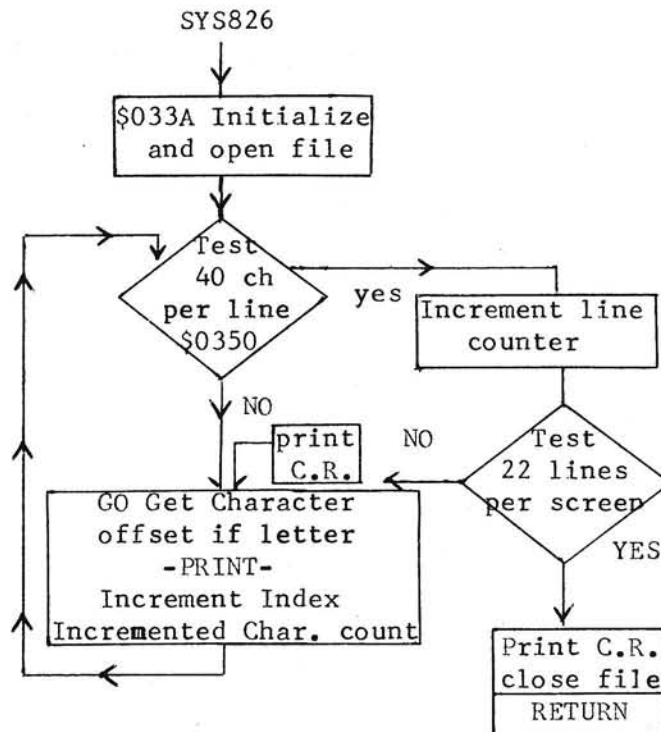

|      |          |          |          |                                       |
|------|----------|----------|----------|---------------------------------------|
| 033A | A9 00    | LDA      | #\$00    |                                       |
| 033C | 8D 56 02 | STA      | \$ 0256  | Printer Secondary Address             |
| 033F | 8D FE 03 | STA      | \$ 03FE  | Screen Line Counter                   |
| 0342 | 8D FF 03 | STA      | \$ 03FF  | Character counter                     |
| 0345 | 85 DA    | STA      | \$ DA    | Index Lo-Byte                         |
| 0347 | A9 01    | LDA      | #\$01    |                                       |
| 0349 | 8D 62 02 | STA      | \$ 0262  | GPiB File Length                      |
| 034C | A9 04    | LDA      | #\$04    |                                       |
| 034E | 8D 42 02 | STA      | \$ 0242  | Logical File #                        |
| 0351 | 8D 4C 02 | STA      | \$ 024C  | Device Number                         |
| 0354 | A2 04    | LDX      | #\$04    |                                       |
| 0356 | 20 C9 FF | JSR      | \$ FFC9  | Open File (i.e. Open 4,4,0)           |
| 0359 | A9 80    | LDA      | #\$80    |                                       |
| 035B | 85 DB    | STA      | \$ DB    | Index Hi-Byte                         |
| 035D | AD FF 03 | LDA      | \$ 03FF  |                                       |
| 0360 | C9 28    | CMP      | #\$28    | 40 Characters per line, test          |
| 0362 | D0 14    | BNE      | \$ 0378  | (GO)                                  |
| 0364 | EE FE 03 | INC      | \$ 03FE  | Increment Line Counter                |
| 0367 | AD FE 03 | LDA      | \$ 03FE  |                                       |
| 036A | C9 16    | CMP      | #\$16    | 22 lines/screen test                  |
| 036C | F0 23    | BEQ      | \$ 0391  | (END)                                 |
| 036E | A9 00    | LDA      | #\$00    |                                       |
| 0370 | 8D FF 03 | STA      | \$ 03FF  |                                       |
| 0373 | A9 0D    | LDA      | #\$0D    | C.R. in ASCII                         |
| 0375 | 20 30 F2 | JSR      | \$ F230  | Print #4,C.R.                         |
| 0378 | 18       | (GO)CLC  |          |                                       |
| 0379 | A2 00    | LDX      | #\$00    |                                       |
| 037B | A1 DA    | LDA      | (\$DA,X) | Get next character via indirect addr. |
| 037D | C9 1F    | CMP      | #\$1F    | Test for Letter                       |
| 037F | 10 02    | BPL      | \$ 0383  |                                       |
| 0381 | 69 40    | ADC      | #\$40    | Offset for Pet screen to ASCII        |
| 0383 | 20 30 F2 | JSR      | \$ F230  | Print #4                              |
| 0386 | E6 DA    | INC      | \$ DA    | Increment index Lo-byte               |
| 0388 | D0 02    | BNE      | \$ 038C  | Branch if not zero                    |
| 038A | E6 DB    | INC      | \$ DB    | Increment Index Hi-byte               |
| 038C | EE FF 03 | INC      | \$ 03FF  | Increment Character counter           |
| 038F | 10 CC    | BPL      | \$ 035D  | Return for next character             |
| 0391 | A9 0D    | (end)LDA | #\$0D    | Ascii C.R.                            |
| 0393 | 20 30 F2 | JSR      | \$ F230  | Print #4                              |
| 0396 | A9 04    | LDA      | #\$04    |                                       |
| 0398 | 20 CC FF | JSR      | \$ FFCC  | Close 4                               |
| 039B | 60       | RTS      |          | Return                                |

• 033A,039B

|      | 0     | 1     | 2     | 3     | 4 | 5 | 6 | 7 |
|------|-------|-------|-------|-------|---|---|---|---|
| 033A | A9 00 | 8D 56 | 02 8D | FE 03 |   |   |   |   |
| 0342 | 8D FF | 03 85 | DA A9 | 01 8D |   |   |   |   |
| 034A | 62 02 | A9 04 | 8D 42 | 02 8D |   |   |   |   |
| 0352 | 4C 02 | A2 04 | 20 C9 | FF A9 |   |   |   |   |
| 035A | 80 85 | DB AD | FF 03 | C9 28 |   |   |   |   |
| 0362 | D0 14 | EE FE | 03 AD | FE 03 |   |   |   |   |
| 036A | C9 16 | F0 23 | A9 00 | 8D FF |   |   |   |   |

• 033A,039B

|      | 0     | 1     | 2     | 3     | 4 | 5 | 6 | 7 |
|------|-------|-------|-------|-------|---|---|---|---|
| 0372 | 03 A9 | 0D 20 | 30 F2 | 18 A2 |   |   |   |   |
| 037A | 00 A1 | DA C9 | 1F 10 | 02 69 |   |   |   |   |
| 0382 | 40 20 | 30 F2 | E6 DA | D0 02 |   |   |   |   |
| 038A | E6 DB | EE FF | 03 10 | CC A9 |   |   |   |   |
| 0392 | 0D 20 | 30 F2 | A9 04 | 20 CC |   |   |   |   |
| 039A | FF 60 | EA EA | EA EA | EA EA |   |   |   |   |



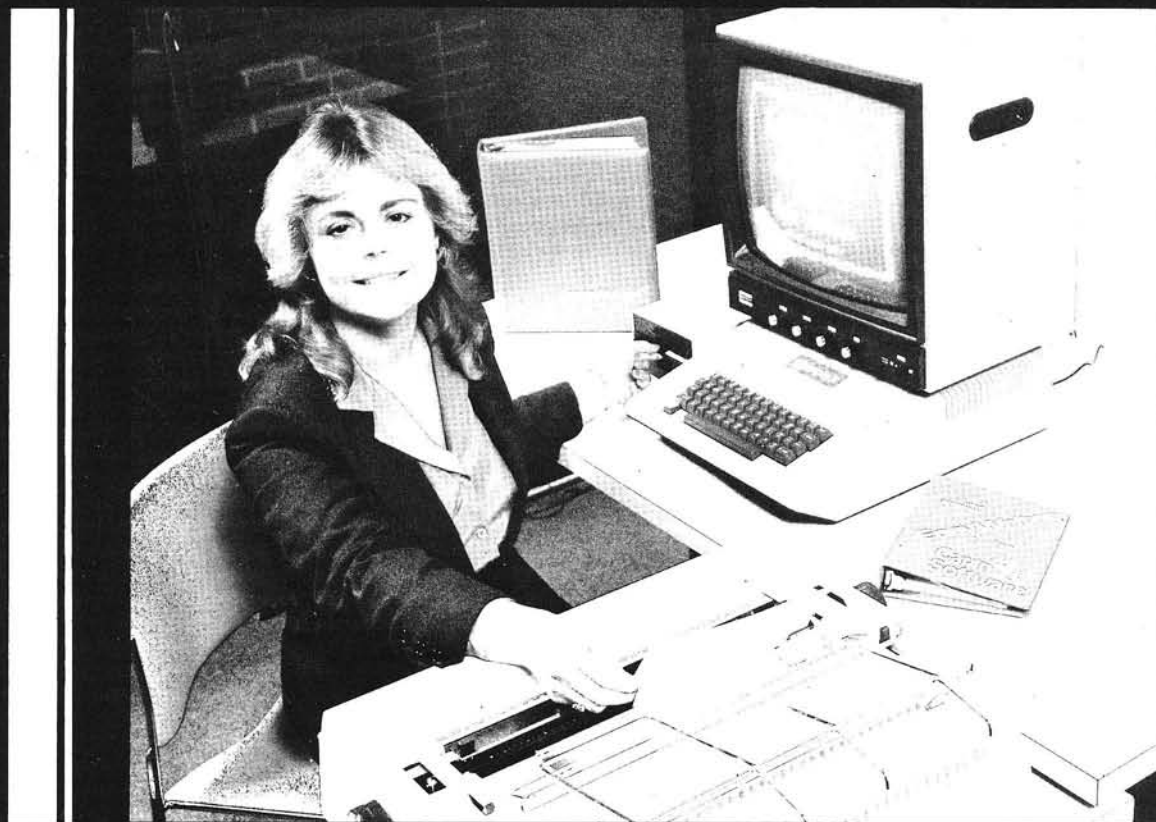

*"As manager of Personal Computers, here at Computerland of San Francisco, evaluating new software products is part of my job. With all the word processors on the market today, I choose EasyWriter for my business and personal use."*

*—Karen Dexter Weiss*

# EasyWriter<sup>TM</sup>

## 80 COLUMNS OF WORD PROCESSING POWER FOR YOUR APPLE II COMPUTER

Finally . . . INFORMATION UNLIMITED SOFTWARE is able to bring you a complete word processing system for the Apple II. The new EasyWriter system gives you **80 columns of upper and lower case characters** for your Apple's video display, using the new SUP'R'TERM 1 board!



You can purchase the new EasyWriter 80 column word processing system as a complete hardware and software package directly from our new office in California, or from your local computer dealer.

A long time ago, we decided to bring you the best simple-to-use and understand tools for your computer system. Today we've taken another stride in that same direction. It took some doing, in both hardware and software, but we think you'll agree that for the buck, no one can touch us.

Check it out:

- 80 Columns on the Screen!
- Upper & Lower Case!
- Global Search & Replace!
- Underlining!
- Bidirectional Printing!
- Incremental Spacing!
- File Appending!
- 50 Pages of Text Per Disk!



Information Unlimited Software, Inc.  
793 Vincente St.  
Berkeley, CA 94707  
(415) 525-4046

- EasyWriter is a TM of Cap'n Software, Inc.
- Apple II is a TM of Apple Computers, Inc.

See The System at the 5th West Coast Computer Faire.



**compas**  
**microsystems**

P.O. Box 687  
224 S.E. 16th Street  
Ames, Iowa 50010

## DAIM

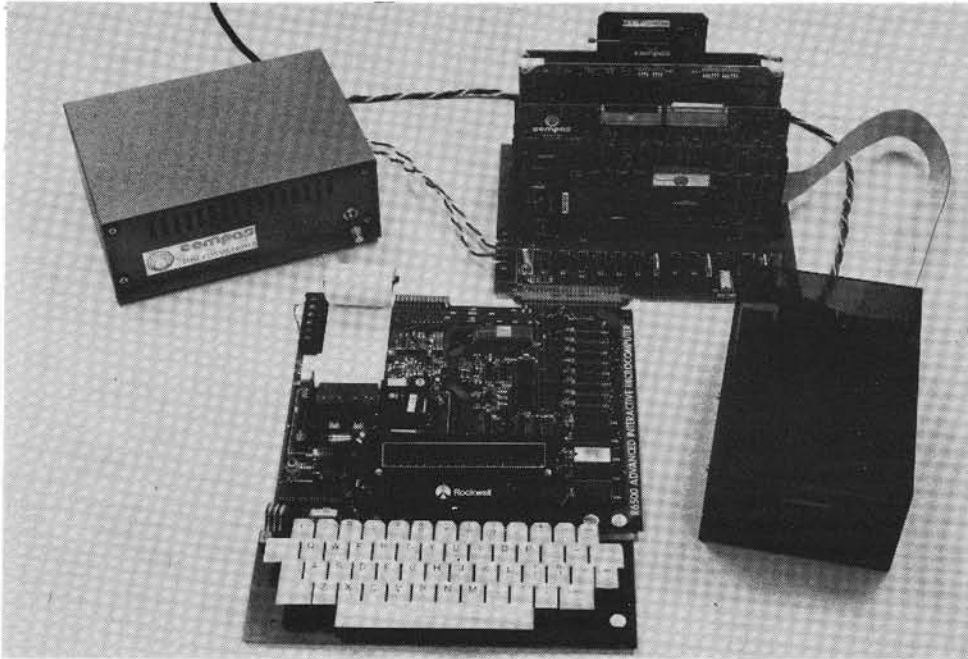

DAIM is a complete disk operating system for the ROCKWELL INTERNATIONAL AIM 65. The DAIM system includes a controller board (with 3.3K operating system in EPROM) which plugs into the ROCKWELL expansion motherboard, packaged power supply capable of driving two 5 1/4 inch floppy drives and one or two disk drives mounted in a unique, smoked plastic enclosure. DAIM is completely compatible in both disk format and operating system functions with the SYSTEM 65. Commands are provided to load/save source and object files, initialize a disk, list a file, list a disk directory, rename files, delete and recover files and compress a disk to recover unused space. Everything is complete — plug it in and you're ready to go! DAIM provides the ideal way to turn your AIM 65 into a complete 6500 development system. Also pictured are CSB 20 (EPROM/RAM) and CSB 10 (EPROM programmer) which may be used in conjunction with the DAIM to provide enhanced functional capability. Base price of \$850 includes controller board with all software in EPROM, power supply and one disk drive. Now you know why we say —

*There is nothing like a*

**DAIM**

**Phone 515-232-8187**

# Polling OSI's Keyboard

---

The "Polled Keyboard" technique used by OSI and others permits the user to define the function of the various keys to his own specifications, and to change them at will. Even though your keyboard may appear to be UPPER case only, it is easy to make it lower case as well.

---

Edward H. Carlson  
3872 Raleigh Drive  
Okemos, MI 49964

OSI machines come with a polled keyboard arranged in the standard 53 key format. Each key is a switch whose state (open or closed) can be ascertained under software control. Polled keyboard hardware affords maximum flexibility to the programmer. The most immediate use of the keyboard is for input to BASIC and other standard software which expects letters to be ASCII capitals but numbers and symbols to be unshifted. For this reason, the keyboard ROM in OSI machines has been programmed to yield capital letters and unshifted numbers when the SHIFT LOCK key is depressed. I am writing an editor program and desire the keyboard to act in the conventional "typewriter" manner with respect to shifting. The Program Listing gives a subroutine (lines 80 to 730) for returning the standard ASCII from the keyboard, and a driver program (lines 10 to 70) to demonstrate the subroutine. As a bonus, all the function keys (ESC, etc.) ignored by the OSI ROM are implemented to yield standard ASCII code.

When called, the subroutine loops until a key (other than SHIFT or CTRL) is depressed, then returns with the appropriate ASCII code in bits 0 through 6 of the accumulator. If CTRL was also depressed, bit 7 in the accumulator is set (1), otherwise it is reset (0). Except for the

CTRL and SHIFT keys, the routine expects only one key to be depressed at a time. The routine detects the first character key depressed if several are depressed at the same time. The subroutine clobbers the X register.

Several choices have been made which you can easily change. The SHIFT LOCK key is ignored. The program works the same whether it is depressed or not. AND #7 in line 540 will enable the SHIFT LOCK key. LEFT and RIGHT SHIFT keys are made equivalent, just as on a typewriter. Since REPT is not an ASCII signal, I chose the code \$00 for it arbitrarily. The BREAK key on OSI machines is hard wired to the reset line of the 65XX chips and so is not detectable by this program. ESC, RUB OUT, LINE FEED, and RETURN have ASCII codes \$1B, 7F, 0A, and 0D respectively.

The keys are arranged electrically as an 8x8 matrix. I will not discuss this matrix in detail. It is shown in the OSI Graphics Manual. The first row of the matrix contains only control keys: LEFT SHIFT, RIGHT SHIFT, SHIFT LOCK, REPT, CTRL, and ESC. I call this row CTLROW and read it first. If the REPT or ESC keys are depressed, the program returns immediately with the appropriate code. If not, CTLROW is saved and rows 2 through 8 are polled for character keys.

RUB OUT, LINE FEED, and RETURN are included among the character keys. When shifted, they give \$20 "space" as their code. You could change line 730 so that some other ASCII function not represented on the keyboard (for example, \$07 "bell") would be signaled. The polling for character keys continues in a loop until a key closure is detected. Then its ASCII code is put in the accumulator. If a SHIFT key is down, the shifted code is put in the accumulator. Then the CTRL key closure is tested. Bit 7 of the accumulator is set if appropriate.

All this happens in a millisecond or so. Many uses of the subroutine will require a check to see if the keyboard is clear of the old keystroke so that a new keystroke can be sought. The KYDONE subroutine (lines 740 to 780) accomplishes this. Once entered, KYDONE (ignoring the CTLROW keys) loops until there are no depressed keys on the keyboard, then returns.

A modified KYDONE could be a useful element in a more sophisticated keyboard program. One may wish to implement the repeat-after-a-delay mode that OSI uses in its keyboard routine. Or a two-key-rollover mode can be implemented which allows recovery from errors induced by fast, sloppy typing.





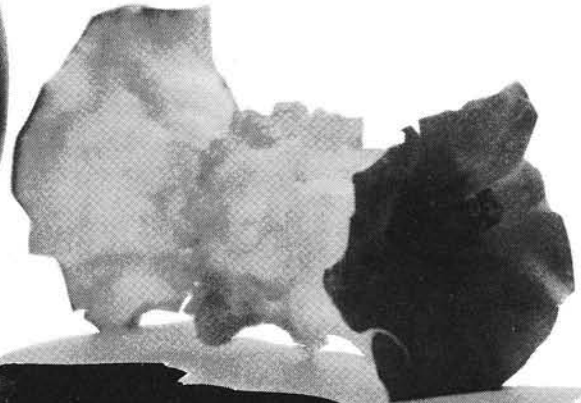
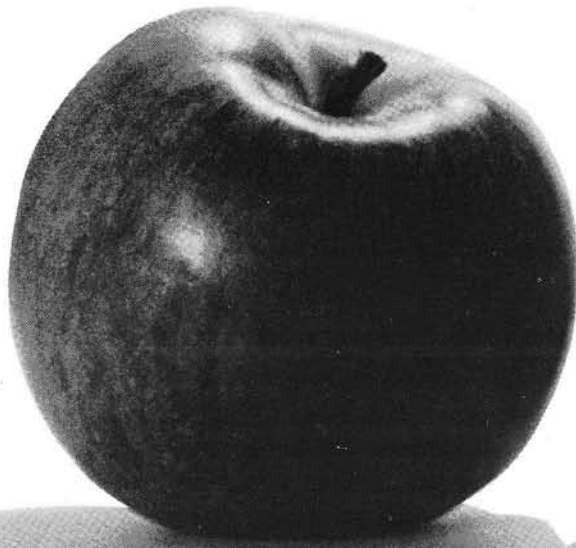

## Introducing AppleSeed, our newest publication to whet your Apple\* appetite!

We invite you to subscribe to AppleSeed - the magazine that is to the Apple II\* what SoftSide is to the TRS-80\*\*. It offers the newest in software programming hints and ideas tailored especially for your computer. AppleSeed features challenging programs for both the do-it-yourselfer and the individual interested in pre-packaged programs and games ... your own preview of the best available on the market today. A typical slice of AppleSeed consists of one major (new 16K) commercial level program (completely listed for your keying pleasure), accompanied by two or three applications for practical use or fun, supplemented by informative articles to polish your Apple\*. Get right to the core of your Apple\* needs and order AppleSeed today! 12 issues, 1 year, \$15.00. AppleSeed is the newest member of ...

**SoftSide™**

**PUBLICATIONS**

6 South Street, Millford, NH 03055  
(803) 673-5144

\*A registered trademark of Apple Computers. \*\*A registered trademark of Radio Shack and Tandy Corp.

# A Digital Thermometer for the APPLE II

---

**Thermistor probes can be connected directly to the APPLE II Game I/O Connector and their output signals processed via a linearizing algorithm to produce a digital display in both degrees Celsius and Fahrenheit.**

---

Carl J. Kershner  
2123 Timberidge Circle  
Dayton, OH 45459

*Thermistor probes can be connected directly to the APPLE II Game I/O Connector and their output signals processed via a linearizing algorithm to produce a digital display in both Celcius and Fahrenheit.*

A thermistor temperature measuring probe can be directly connected to the APPLE II computer via its built-in Game I/O Connector. This is possible since thermistors are "thermal resistors" which exhibit large resistance changes in response to a change in temperature and paddle input ports, PDL(0,1,2,&3), on the APPLE are essentially eight bit A/D converters for such variable resistance sources.

The APPLE and the thermistor are quite suited for one another since the inherent nonlinearity of the thermistor can be easily handled with a simple algorithm in software. In addition, the small current drain during the sampling cycle of the RC network on the APPLE's 553 timer closely approaches the ideal zero-power operating condition for a thermistor. Both the nonlinearity and the induced temperature due to the probing current have been particularly troublesome characteristics which engineers have had to find ways of working around when applying thermistors.

The program written in Applesoft consists of an input section, a data reduction section and a display section. The input section calls for the selection of a paddle input and two thermistor specifications used by most manufacturers; the room temperature resistance designated as RO and a value representing the ratio of the resistance at 25°C to that at 50°C designated as RA. The selected paddle input is then read and scaled to represent the resistance value at the input port. The corresponding temperature in both degrees Celcius and Fahrenheit are calculated from the resistance via a temperature-resistance relationship:

$$R_1/R_2 = e^{\beta(1/T_1 - 1/T_2)}$$

where R1 and R2 are the resistances at the absolute temperature T1 and T2 respectively, and  $\beta$  is a constant for the particular thermistor material. The results are rounded to the nearest integer and displayed in a three digit format with the blanking of leading zeros and a negative sign for temperatures below zero.

A thermistor probe can be connected to the APPLE II by merely attaching one of its leads to the +5 volt supply, pin 1, and the other to one of the

PDL ports, pins 6,7, 10, or 11 on the Game I/O connector J 14. No other components or modifications are required so long as a thermistor is chosen with a room temperature resistance and ratio which suits the temperature range and sensitivity desired for application. A 40,000 ohm thermistor with a ratio of 9 or 10 will provide at least one degree Fahrenheit sensitivity and a working range suitable for an indoor thermometer application. The best way to choose a thermistor for your particular application is to run the program using a game paddle as input, enter values for RO and the RA from a manufacturer's specification sheet, and observe the useful operating range and sensitivity of the selected thermistor. This latted procedure demonstrates the additional usefulness of the program as an engineering design aid in selecting thermistor for other applications.

Thermistors suitable for this application can be purchased for less than five dollars from most supply houses or directly from a manufacturer. A Fenwal GA44P2 glass probe type thermistor with a room temperature resistance of 40,000 ohms and a ratio of 9.53 is a good choice for an indoor thermometer application, whereas a Fenwal GA42P2 with a room temperature resistance of 15,000 ohms and a ratio of 9.1 is a good compromise

for indoor-outdoor use. It is best to house the thermistor probe in a small metal tube to protect it from mechanical damage and to provide thermal inertia to minimize effects of short term temperature transients. It is also advisable to calibrate the thermistor probes against a laboratory type thermometer, if high accuracy is desired, because the manufacturing

tolerances on RO and RA values for the inexpensive probes described here are generally no better than  $\pm 10\%$ .

Because thermistors can be used that have relatively high resistances, transmission line and contact temperature effects can be neglected and the probes can be situated far from the

computer console. Thus the APPLE II digital thermometer can perform many useful temperature monitoring tasks in and around the house.

*The Fenwal products mentioned in this article can be purchased from Fenwal Electronics, 63 Fountain St., PO Box 585, Framingham, MA 01701.*

```

LIST
100 REM DIGITAL THERMOMETER FOR THERMISTOR PROBE(DISPLAYS
    BOTH CELCIUS &FAHRENHEIT)
110 PRINT "WHICH INPUT DO YOU WANT(0,1,2,3)": INPUT NUMBER
120 PRINT "WHAT THERMISTOR CONSTANTS DO YOU WANT(RO,RATIO)":
    INPUT RO,RA
125 BETA = 1.7636E3 * LOG (RA)
130 HOME : REM CLEAR SCREEN
140 REM PRINT TEMPERATURE SCALE CHARACTERS
150 GR : COLOR= 15
160 HLIN 26,27 AT 6: HLIN 26,27 AT
    7: HLIN 26,27 AT 9: HLIN 26,
    27 AT 10: VLIN 7,9 AT 25: VLIN
    7,9 AT 28
170 HLIN 34,38 AT 9: HLIN 34,38 AT
    10: HLIN 34,36 AT 14: HLIN 3
    4,36 AT 15: VLIN 9,20 AT 33
180 HLIN 26,27 AT 23: HLIN 26,27
    AT 24: HLIN 26,27 AT 26: HLIN
    26,27 AT 27: VLIN 24,26 AT 2
    5: VLIN 24,26 AT 28
190 VLIN 28,29 AT 38: VLIN 27,28
    AT 37: VLIN 26,27 AT 36: VLIN
    26,27 AT 35: VLIN 27,28 AT 3
    4
200 VLIN 28,35 AT 33: VLIN 35,36
    AT 34: VLIN 36,37 AT 35: VLIN
    36,37 AT 36: VLIN 35,36 AT 3
    7: VLIN 34,35 AT 38
210 T = 298: REM SET T(0) AT 29
    8 DEGREES ABSOLUTE
220 RI = 589.94 * PDL (NUMBER): REM
    READ INPUT & SCALE TO OHMS
230 IF RI = 0 THEN RI = 1: REM
    PREVENT DIVISION BY ZERO
240 TC = INT (1 / (1 / T - LOG
    (RO / RI) / BETA) - 272.5): REM
    CALCULATE TEMPERATURE IN D
    EGREES CELCIUS AND ROUND TO
    NEAREST INTEGER
245 IF ABS (TC) > 999 THEN GOTO
    220: REM LIMIT OVERFLOWING
    DISPLAY
250 SIGN = 0
260 IF TC < 0 THEN SIGN = 15
270 COLOR= SIGN
280 HLIN 3,5 AT 29: HLIN 3,5 AT
    30: REM DISPLAY NEGATIVE S
    IGN
290 TC = ABS (TC)
300 J = INT (TC / 100):I = J: REM
    SEPARATE HUNDRED'S DIGIT
310 IF J = 0 THEN J = 10: REM
    BLANK LEADING ZERO
320 X = 1:Y = 26: GOSUB 1000: REM
    DISPLAY CELCIUS HUNDRED'S
330 J = INT ((TC - J * 100) / 10
    ): REM SEPARATE TEN'S DIGI
    T
340 IF I = 0 AND J = 0 THEN J =
    10: REM BLANK BOTH HUNDRED
    'S AND TEN'S LEADING ZEROS I
    F J&I ARE BOTH ZERO
350 X = 9:Y = 26: GOSUB 1000: REM
    DISPLAY CELCIUS TEN'S DIGI
    T
360 J = TC - I * 100 - J * 10: REM
    SEPARATE ONE'S DIGIT
370 X = 17:Y = 26: GOSUB 1000: REM
    DISPLAY CELCIUS ONE'S DIGI
    T
380 TF = INT (9 * (1 / (1 / T -
    LOG (RO / RI) / BETA) - 273
    ) / 5 + 32.5): REM CALCULA
    TE FAHRENHEIT & ROUND TO NEA
    REST INTEGER
390 SIGN = 0
400 IF TF < 0 THEN SIGN = 15
410 COLOR= SIGN
420 HLIN 3,5 AT 12: HLIN 3,5 AT
    13: REM DISPLAY NEGATIVE S
    IGN
430 TF = ABS (TF)
440 J = INT (TF / 100):I = J: REM
    SEPARATE HUNDRED'S DIGIT

```



```

450 IF J = 0 THEN J = 10: REM
    BLANK LEADING ZERO
460 X = 1: Y = 9: GOSUB 1000: REM
    DISPLAY FAHRENHEIT HUNDRED
    'S DIGIT
470 J = INT ((TF - I * 100) / 10
    ): REM SEPARATE TEN'S DIGI
    T
480 IF I = 0 AND J = 0 THEN J =
    10: REM BLANK BOTH HUNDRED
    'S AND TEN'S LEADING ZEROS
490 X = 9: Y = 9: GOSUB 1000: REM
    DISPLAY FAHRENHEIT TEN'S D
    IGIT
500 J = TF - I * 100 - J * 10: REM
    SEPARATE ONE'S DIGIT
510 X = 17: Y = 9: GOSUB 1000: REM
    DISPLAY FAHRENHEIT ONE'S D
    IGIT
520 GOTO 220
1000 REM SEVEN SEGMENT ENCODER

1010 ON J GOTO 1110, 1120, 1130, 11
    40, 1150, 1160, 1170, 1180, 1190,
    1200
1100 A = 15: B = 15: C = 15: D = 15:
    E = 15: F = 15: G = 0: GOTO 20
    00
1110 A = 0: B = 15: C = 15: D = 0: E =
    0: F = 0: G = 0: GOTO 2000
1120 A = 15: B = 15: C = 0: D = 15: E
    = 15: F = 0: G = 15: GOTO 200
    0
1130 A = 15: B = 15: C = 15: D = 15:
    E = 0: F = 0: G = 15: GOTO 200
    0

```

```

1140 A = 0: B = 15: C = 15: D = 0: E =
    0: F = 15: G = 15: GOTO 2000
1150 A = 15: B = 0: C = 15: D = 15: E
    = 0: F = 15: G = 15: GOTO 200
    0
1160 A = 15: B = 0: C = 15: D = 15: E
    = 15: F = 15: G = 15: GOTO 20
    00
1170 A = 15: B = 15: C = 15: D = 0: E
    = 0: F = 0: G = 0: GOTO 2000
1180 A = 15: B = 15: C = 15: D = 15:
    E = 15: F = 15: G = 15: GOTO 2
    000
1190 A = 15: B = 15: C = 15: D = 15:
    E = 0: F = 15: G = 15: GOTO 20
    00
1200 A = 0: B = 0: C = 0: D = 0: E =
    0: F = 0: G = 0: J = 0: GOTO 20
    00
2000 REM SEVEN SEGMENT DISPLAY
2010 COLOR= A
2020 HLINE X + 1: X + 4 AT Y
2030 HLINE X + 1: X + 4 AT Y + 1
2040 COLOR= G
2050 HLINE X + 1: X + 4 AT Y + 5
2060 HLINE X + 1: X + 4 AT Y + 6
2070 COLOR= D
2080 HLINE X + 1: X + 4 AT Y + 10
2090 HLINE X + 1: X + 4 AT Y + 11
2100 COLOR= F
2110 VLINE Y + 1: Y + 5 AT X
2120 COLOR= B
2130 VLINE Y + 1: Y + 5 AT X + 5
2140 COLOR= E
2150 VLINE Y + 6: Y + 10 AT X
2160 COLOR= C
2170 VLINE Y + 6: Y + 10 AT X + 5
2180 RETURN

```

CmC

# APPLE ANALOG INPUT

## Analog to Digital Conversion System for the APPLE Computer

µMAC SYSTEMS

Give your APPLE computer the ability to measure and control the world around it with µMAC SYSTEMS modules. Just plug the APSET1 into your APPLE to get 16 channels of analog input. Screw terminals are provided for each channel so you can hook up pots, joysticks, thermometers, light probes, or whatever appropriate sensors you have.

Each of the 16 analog inputs, in the range of 0 to 5.12 volts, is converted to a number between 0 and 255 (20 millivolts per count). Software is included.

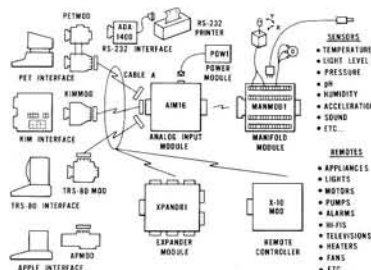

- APSET1
- 1-AIM16 - 16 ANALOG INPUTS - 8 BITS - 100 MICROSEC
  - 1-APMOD - APPLE TO µMAC INTERFACE
  - 1-CABLE A24 - 24 INCH INTERCONNECT CABLE
  - 1-MANMOD1 - MANIFOLD MODULE - SCREW TERMINALS FOR INPUTS, REFERENCE, GROUND
  - 1-POWER1 - POWER MODULE

APSET1a for 110 VAC \$295  
APSET1e for 230 VAC \$305

Order direct or contact your local computer store.

**CONNECTICUT microCOMPUTER, Inc.**  
150 POCONO ROAD  
BROOKFIELD, CONNECTICUT 06804

TEL: (203) 775-9659 TWX: 710-456-0052

VISA AND M/C ACCEPTED-SEND ACCOUNT NUMBER, EXPIRATION DATE AND SIGN ORDER.  
ADD \$3 PER ORDER FOR SHIPPING & HANDLING-FOREIGN ORDERS ADD 10% FOR AIR POSTAGE.

# INTRODUCING . . . NIBBLE THE REFERENCE FOR APPLE COMPUTING

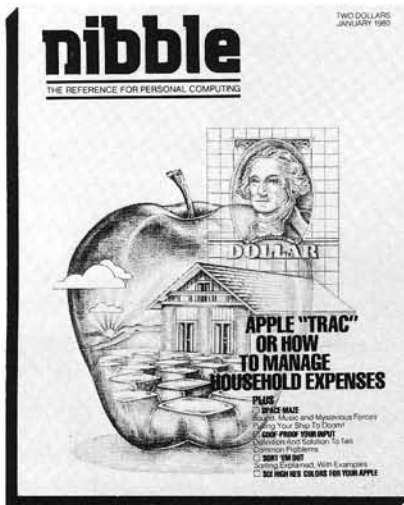

**NIBBLE IS:**  
*A SOFTWARE GUIDE* for high quality Applications Programs for your Home and Business.

**NIBBLE IS:**  
*A REFERENCE GUIDE* to new Programming Methods.

**NIBBLE IS:**  
*A BUYERS GUIDE* for making purchase decisions on new products.

**NIBBLE IS:**  
*A CONSTRUCTION PROJECT COOKBOOK* for adding function and value to the system you already own.

**NIBBLE IS:**  
*A COMMUNICATIONS CLEARING HOUSE* for users, vendors, and associations.

Each issue of NIBBLE features at least one significant new application program of commercial quality. The programs in NIBBLE are surrounded with articles which show how to USE the programming methods in your OWN programs.

Examples of upcoming articles:

- Modeling and Forecasting Your Business  Build a Two-Tape Controller for \$12  
 Arcade Shooting Gallery — Save Your Quarters!  Data Base Management System I, II, III

And many many more! NIBBLE will literally “Nibble Away” at the mysteries of your system to help you USE IT MORE. In 1980, the principal featured system is the Apple II.

**Try a NIBBLE**

**nibble**

BOX 325 Lincoln, Mass. 01773

**I'll try NIBBLE!**

**Enclosed is my \$15 for 8 issues.**

**check**     **money order**

Name \_\_\_\_\_

Address \_\_\_\_\_

City \_\_\_\_\_

State \_\_\_\_\_ Zip \_\_\_\_\_

# Challenger II Cassette Techniques

---

The Challenger II has available a useful feature which allows the storage and retrieval of sequential data files on cassette using SAVE and LOAD commands in a program. This can be used to extend the size of your BASIC programs by permitting DATA to be INPUT from tape as needed.

---

Richard A. Lary  
P.O. Box 234  
Kilauea, HI 96754

Well, I knew it would happen sooner or later. I came across a program which I wished to run on my Challenger II but my 8K of memory was not enough to satisfy the program's appetite.

The desired program used several arrays to store variable values with DATA statements being used to supply the required values for the arrays. After dimensioning the arrays and entering all the required DATA statements, I discovered, much to my dismay, that these two steps had consumed nearly the entire 8K. What to do...?

After staring blankly at the CRT for several minutes wondering what I was going to do, I remembered reading something in my system documentation about entering data files from the cassette interface using the INPUT statement. This seemed to be my only hope to get the program running.

The Challenger II has a useful feature available which allows you to conveniently store and retrieve sequential data files on cassette using SAVE and

LOAD commands as part of a program. The remainder of this article will describe a simple method to make use of this feature.

The first step is to store the data in a sequential file on cassette tape. Program 1 shows how this can be done. Program line 20 allows for setup and start of the recorder before the data file is recorded. Line 30 is a programmed SAVE instruction which, when executed, turns on the cassette output such that any ASCII characters listed or printed after the SAVE instruction will be output to the cassette tape. Lines 40-70 form a loop which reads data from lines 100 and 110, prints the data on the screen and outputs the data to the cassette, one variable at a time, each variable being followed by the PRINT command's carriage return.

Program 1 shows how to use DATA statements as the data source. Program 1 can be modified, as shown in Program 2 to load the data variables into an array via the keyboard and INPUT statement and then dump the array variables to the cassette. In Program 2, lines 20-60 input

and store the variables in the array "D"; lines 80-110 create the sequential data file on tape as in Program 1. Line 70 allows you to set up and start your recorder before the data file is actually created.

It is very important to insure that there is no unwanted data stored on the cassette tape immediately before the start of the data file because this erroneous data will be mistaken for real data by the program which retrieves the data file. This is easy to accomplish if your recorder erases previous data before it records new data. If your recorder operates in this manner, simply allow the recorder to run in its record mode for approximately 10 seconds before the save portion of Programs 1 or 2 are executed. Doing so will create a leader free of erroneous data before the start of the data file. If your recorder does not erase before it records, you will have to use a method compatible with your recorder which will erase a portion of the tape before the start of the data file.

After you have recorded your data file using Program 1 or 2, the next task is to retrieve the data.

Program 3 demonstrates a method for retrieving the data. Program 3 will allow you to retrieve the sample data file you created using Program 1. Line 20 dimensions the array into which the data is to be stored as it is retrieved from the data file. You must be sure to dimension the array so it will be large enough to store all your data variables. In this case, the array is dimensioned to ten since we'll only have ten variables. Line 30 is a programmed LOAD instruction which allows the INPUT statement in line 50 to accept inputs from the cassette. Lines 40-60 form a loop which reads the data file from the cassette and stores the data variables in array "D".

Line 70 stores a decimal 0 at decimal memory location 515. On the Challenger II this memory location is a flag which controls the system monitor's cassette load routine. A decimal 0 stored at the location exits the routine and a decimal 255 stored at the same location will enter the load routine. It is necessary to exit the load routine in this manner so that the program using the array variables will be executed directly, without the program stopping after the array is filled. If the program was stopped after the array had been filled to exit the load routine in the usual fashion (space bar, carriage return, etc.), it would be necessary to type RUN to restart the program. Each time you type RUN all variables are set to zero; this would include the array we just filled with data from the data file.

Lines 80-130 in Program 3 simply list the variables which were retrieved from the data file so you can see how this technique works.

In the actual use of Program 3, the program which will use the retrieved data would follow immediately after line 70.

To demonstrate the retrieval of a data file, enter Program 3; place the tape with the data file you created with Program 1 into your recorder. Rewind the tape to the erased leader portion you created. Type RUN. The INPUT statement's question mark will appear to signify that the program is waiting for input from the cassette interface.

You can now start your recorder in its playback mode, and upon the tape reaching the start of the data file the first data variable will appear following the question mark. Another question mark will appear followed by the second data variable and so on until all data has been retrieved.

When the last data variable has been

```
10 REM WRITE DATA FILE TO CASSETTE FROM DATA STATEMENTS
20 INPUT 'SET UP AND START RECORDER...TYPE'1' TO RECORD DATA'; A
30 SAVE
40 FOR I = 1 TO 10
50 READ D
60 PRINT D
70 NEXT I
80 END
100 DATA 1,2,3,4,5
110 DATA 6,7,8,9,10
```

Listing 1

```
10 REM WRITE DATA FILE TO CASSETTE FROM AN ARRAY
20 INPUT 'HOW MANY FILES IN DATA FILE';N
30 DIM D(N)
40 FOR I = 1 TO N
50 INPUT 'DATA'; D(I)
60 NEXT I
70 INPUT 'SET UP AND START RECORDER...TYPE '1' TO RECORD DATA';A
80 SAVE
100 PRINT D(I)
110 NEXT I
120 END
```

Listing 2

```
10 REM RETRIEVE DATA FILE
20 DIM D(10)
30 LOAD
40 FOR I = 1 TO 10
50 INPUT D(I)
60 NEXT I
70 POKE 515,0 : REM EXIT MONITER CASSETTE LOAD ROUTINE
80 REM THE PROGRAM USING DATA ARRAY WOULD START HERE
90 REM PRINT OUT ARRAY FOR TEST OF TECHNIQUE
100 FOR I = 1 TO 10
110 PRINT D(I)
120 NEXT I
130 END
```

Listing 3

retrieved, Program 3 will list the "D" array so you can see that the array now contains the data retrieved from the data file.

If you should discover that the first data variable is something other than what it should be, chances are that the leader before the data file had not been adequately erased or you may have started the tape playback somewhere other than in the erased leader portion of the tape.

To keep these programs short and simple, I used numerical data and a single one dimensional array. By modifying these programs using nested FOR-NEXT loops in place of the single loops, you can save and retrieve data in two dimensional arrays.

Data can also be saved and retrieved in several different arrays by using one or more FOR-NEXT loops, one for each array, one after another in each of the programs. It is also possible to save and retrieve string data files by using string variables in place of the numerical which were used in these simple programs.

I have obtained reliable results using these programs. Simple modifications such as I have mentioned have allowed me the pleasure of running some programs which I have previously been unable to run.

Hopefully I have provided you with a simple but useful technique to create and retrieve cassette data files with your Challenger II.

## 16K MEMORY

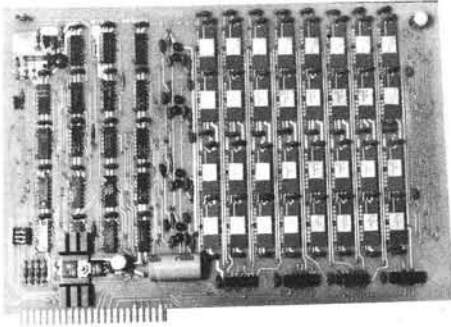

K-1016

- ADDRESSED AS CONTIGUOUS 16K STARTING AT ANY 8K BOUNDARY
- LOW POWER — 1.6 WATTS TOTAL
- K-1016A — \$340 6 MONTH WARRANTY

## SYSTEM EXPANSION

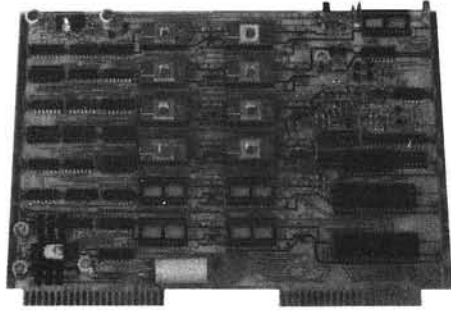

K-1012

- 12 PROM SOCKETS — 2708/TMS 2716, USES THE POWER OF ONLY 1 PROM.
- 32 BIDIRECTIONAL I/O LINES
- FULL RS-232 ASYNC SERIAL COMMUNICATIONS, 75-4800 BAUD
- PROM PROGRAMMER
- K-1012A — \$295

# EXPANSION FOR YOUR 6502 COMPUTER

## HIGH RESOLUTION GRAPHICS

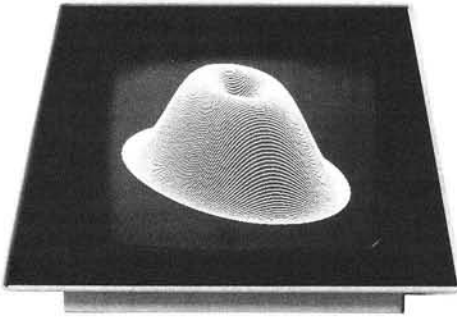

- 320 x 200 BIT MAPPED GRAPHICS
- 8K RAM AVAILABLE FOR USE
- EACH POINT INDIVIDUALLY ADDRESSABLE
- K-1008A — \$240, PET — \$243 (PLUS PET INTERFACE)

## MULTI-HARMONIC 4 VOICE MUSIC

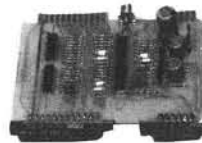

K-1002-2

MODEL FOR ALL PETS

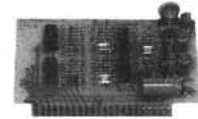

K-1002

MODEL FOR KIM, AIM, SYM

- FORIER SYNTHESIZED WAVEFORMS — UP TO 16 HARMONICS
- 4 VOICES PLAY SIMULTANEOUSLY
- QUALITY D/A CONVERTER, 6 POLE FILTER AND AMPLIFIER
- HARDWARE — \$40-50, SOFTWARE — \$20



ALL MTU PRODUCTS ARE SUPPLIED WITH FULL DOCUMENTATION CLASSED AS "BEST IN THE INDUSTRY". MANUALS MAY BE PURCHASED SEPARATELY.



**Micro Technology Unlimited**

P.O. Box 4596, 841 Galaxy Way  
Manchester, N.H. 03108  
603-627-1464

Call Or Write For Our Full Line Catalog

# EXCERT, INCORPORATED

● ● ● AIM - 65 ● ● ●

## SPECIAL

A65-4AB                      AIM-65 w/4K RAM  
Assembler and BASIC ROM                      \$595

### P/N

QTY 1 - 9

|       |                 |       |       |
|-------|-----------------|-------|-------|
| A65-1 | AIM-65 w/1K RAM | ..... | \$375 |
| A65-4 | AIM-65 w/4K RAM | ..... | \$450 |
| A65-A | Assembler ROM   | ..... | \$85  |
| A65-B | BASIC ROM       | ..... | \$100 |

### SPARE PARTS (When Available)

|       |                         |       |      |
|-------|-------------------------|-------|------|
| A65-P | Printer                 | ..... | \$40 |
| A65-D | Complete Display Board  | ..... | \$65 |
|       | w/Exchange of Old Board | ..... | \$40 |
| A65-K | Keyboard                | ..... | \$40 |

## ACCESSORIES

### P/N

QTY 1 - 9

#### Power Supplies

|      |                                                      |       |      |
|------|------------------------------------------------------|-------|------|
| PRS3 | +5V at 3A, +24V at 1A<br>w/mtg hardware, cord, etc.  | ..... | \$65 |
| PRS4 | +5V at 2A, +24V at .5A<br>w/mtg hardware, cord, etc. | ..... | \$50 |

#### From The Enclosures Group

|       |                                                              |       |      |
|-------|--------------------------------------------------------------|-------|------|
| ENC1  | AIM-65 case w/space for PRS3/PRS4                            | ..... | \$45 |
| ENC1A | AIM-65 case w/space for PRS3/PRS4<br>and one expansion board | ..... | \$49 |

#### Cases with Power Supplies

|       |                             |       |       |
|-------|-----------------------------|-------|-------|
| ENC3  | ENC1 w/PRS3 mounted inside  | ..... | \$115 |
| ENC3A | ENC1A w/PRS3 mounted inside | ..... | \$119 |
| ENC4  | ENC1 w/PRS4 mounted inside  | ..... | \$100 |
| ENC4A | ENC1A w/PRS4 mounted inside | ..... | \$104 |

#### From The Computerist, Inc.

|      |                                                                                                                              |       |       |
|------|------------------------------------------------------------------------------------------------------------------------------|-------|-------|
| MCP1 | Mother Plus™ Dual 44 pin mother card<br>takes MEB1, VIB1, PTC1, fully buffered,<br>5 expansion slots underneath the AIM      | ..... | \$80  |
| MEB1 | Memory Plus™ 8K Ram, 8K Prom sockets,<br>6522 I/O chip and programmer for 5V<br>EPROMS with cables                           | ..... | \$200 |
| PTC1 | Proto Plus™ Prototype card same size<br>as KIM-1, MEB1, VIB1                                                                 | ..... | \$40  |
| VIB1 | Video Plus™ board with 128 char, 128 user<br>char, up to 4K display RAM, light pen and<br>ASCII keyboard interfaces w/cables | ..... | \$245 |

### P/N

QTY 1 - 9

#### From Seawell Marketing, Inc.

|       |                                                                                                                                                                                                                |       |       |
|-------|----------------------------------------------------------------------------------------------------------------------------------------------------------------------------------------------------------------|-------|-------|
| MCP2  | Little Buffered Mother™ Single 44 pin<br>(KIM-4 style) mother card takes MEB2,PGR2,<br>PTC2 and PIO2. Has on board 5V regulator for<br>AIM-65, 4 expansion slots. Routes A&E<br>signals to duplicates on sides | ..... | \$139 |
|       | with 4K RAM                                                                                                                                                                                                    | ..... | \$189 |
| MEB2  | SEA 16™ 16K static RAM board takes 2114L<br>with regulators and address switches                                                                                                                               |       |       |
|       | Blank                                                                                                                                                                                                          | ..... | \$125 |
|       | 8K                                                                                                                                                                                                             | ..... | \$225 |
|       | 16K                                                                                                                                                                                                            | ..... | \$325 |
| PGR2  | Prommer™ Programmer for 5V EPROMS<br>with ROM firmware, regulators, 4 textool<br>sockets, up to 8 EPROMS simultaneously, can<br>execute after programming                                                      | ..... | \$245 |
| PIO2  | Parallel I/O board with 4-6522's                                                                                                                                                                               | ..... | \$260 |
| PTC2  | Proto/Blank™ Prototype card that<br>fits MCP2                                                                                                                                                                  | ..... | \$39  |
| PTC2A | Proto/Pop™ with regulator, decoders,<br>switches                                                                                                                                                               | ..... | \$99  |

#### From Beta Computer

|      |                                                                            |       |       |
|------|----------------------------------------------------------------------------|-------|-------|
| MEB3 | 32K Dynamic Memory Card w/on board DC to<br>DC converters (5V only .8Amax) | ..... | \$419 |
|      | with 16K                                                                   | ..... | \$349 |
|      | with OK                                                                    | ..... | \$279 |

#### Miscellaneous

|      |                                             |       |      |
|------|---------------------------------------------|-------|------|
| TPT2 | Approved Thermal Paper Tape<br>5/165' rolls | ..... | \$10 |
| MEM6 | 6/2114 RAM Chips                            | ..... | \$45 |

## SYSTEMS

We specialize in assembled and tested systems made from the above items. Normally, the price will be the total of the items, plus \$5 for shipping, insurance and handling. Please call or write for exact prices or if questions arise. Six month warranty on all systems.

Mail Check or Money Order To:

**EXCERT, INC.**

P.O. Box 8600

White Bear Lake, MN 55110

(612) 426-4114

Higher quantities quoted upon request.  
COD's accepted.  
Add \$5.00 for shipping, insurance and handling.  
Minnesota residents add 4 % sales tax.

# Beginning Boolean: A Brief Introduction to Boolean Algebra for Computerists

It makes no difference if your computer is maxi or micro, if you program in machine code, BASIC or Pascal, if you do simple games or complex real-time simulations. In the final analysis: "It's All Ones and Zeros". How these ones and zeros are used is the topic of this primer.

Dr. Marvin DeJong  
 Dept. of Mathematics & Physics  
 The School of the Ozarks  
 Point Lookout, MO 65726

Boolean algebra, invented by George Boole in the early 1800's, is useful in programming a microcomputer for logic design, designing interface circuits, and understanding the functions of integrated circuits. The last point is illustrated by opening the *TTL Data Book* and looking for logical expressions. For example, the 7453 is described by  $Y = \overline{AB} + CD + EF + GH + X$  which has to be somewhat of a mystery without any Boolean background. The name tends to scare people, but it turns out that there is a very simple approach to learning Boolean algebra, namely Boolean arithmetic. Anyone who can accept that  $1 + 1 = 1$ , can also learn Boolean. If you're an electrical engineer or a professional computer scientist, turn to the next article; otherwise give it a try.

## Beginning Boolean

Boolean arithmetic is super-simple; there are only two numbers, zero and one. There are only two operations symbolized by  $+$  and  $\cdot$ .<sup>\*</sup> Long division is out, and there is not a minus sign in sight. Figure 1 summarizes all you need to know about the  $+$  operation which is called "OR" rather than addition.

<sup>\*</sup>The symbols  $\vee$  and  $\wedge$  frequently replace  $+$  and  $\cdot$ , respectively. The dot ( $\cdot$ ) is sometimes implied, that is  $A \cdot B = AB$ .

The OR facts are read "0 or 0 equals 0," *not* "0 plus 0 equals 0." Mumble these facts to yourself several times in the privacy of your own home. That will help you get a feeling for them. It is important to relate the OR operation with the circuit in Figure 1. A and B stand for switches. If switch A is closed then  $A = 1$ ; if it is open then  $A = 0$ . The same holds for switch B. Light L is off when  $L = 0$  and it shines when  $L = 1$ . Referring to either the OR table or the OR facts in Figure 1, it is seen that if both switches are open we have  $0 + 0 = 0$  so the light is off. Likewise, the fact that  $1 + 0 = 1$  means that if switch A is closed, but B is open, then  $L = 1$  so the light is on. This should also be obvious from the circuit. The last two OR facts are equally obvious to anyone who has played with switches and light bulbs. Slipping in a little algebra, unnoticed of course, the circuit is summarized by the simple equation:

$$A + B = L, \quad (1)$$

which gives the correct value for L for each of the four possible combinations of switch settings. Go back and study the table and this paragraph again if you haven't understood.

Before proceeding, a more conventional representation of the OR operation

should be given, and surprisingly enough it appears in Figure 2. The information in Figure 2 is no different than in Figure 1, only the form has been changed. Actually the truth table has nothing to do with telling the truth or telling lies, but that's another story. Suffice it to say that somebody thought if everyone were

|     |     |     |             |
|-----|-----|-----|-------------|
| $+$ | $0$ | $1$ | $0 + 0 = 0$ |
| $0$ | $0$ | $1$ | $1 + 0 = 1$ |
| $1$ | $1$ | $1$ | $0 + 1 = 1$ |
|     |     |     | $1 + 1 = 1$ |

a) OR Table      b) OR Facts

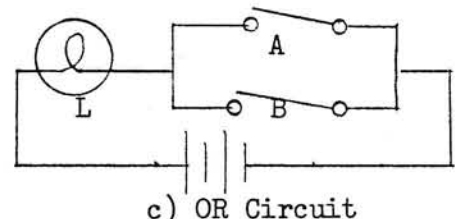

Figure 1: Summary of the properties of the OR operation.

logical we could sort truth from lies and the world would be a better place to live. Dream on!

If you will drop your conservative image for a moment, we might let A and B stand for a string of eight digits each instead of one digit each. Also, let the OR operation be applied to the digits of A and B in sequence. An example is shown in Figure 3. Hopefully you can reproduce this calculation in your own mind. Don't do anything heavy like "carry" or "borrow," just take two digits at a time, one from A and one from B, and apply the OR rule to them.

Since you are very likely the proud owner of an 8-bit computer, an examination of the instruction set will reveal an OR command which does what has just been described. The reader is left with a few problems. Assuming that you are familiar with representing 8-bit binary numbers with hexadecimal (hex) numbers, do the following OR problems. Answers to the first two are given.

|              |           |
|--------------|-----------|
| 11 + FE = FF | FF + 2B = |
| 7F + 7F = 7F | 00 + 3E = |
| 22 + 01 =    | FO + 5E = |
| 3C + 00 =    | FF + 00 = |
| 12 + 34 =    |           |

Having experienced the intellectual rewards of having mastered the OR operation, you will want to proceed to the AND operation.

#### AND Away We Go

Figure 4 summarizes the AND operation in the same fashion as Figure 1 treated the OR operation. The AND circuit is a series circuit, requiring that both A and B be on (hence the name) for the light L to light. This is in contrast to the OR circuit which lights if either A or B is on.

Notice that "ANDING" works the same way as old-fashioned multiplication with no weird results like  $1 + 1 = 1$  which we obtained with the OR. The AND facts are read "0 and 0 equals 0," or "1 and 1 equals 1." The equation which describes the circuit is:

$$A \cdot B = L, \quad (2)$$

the truth of which may be verified by substitution and comparison with the simple series circuit. As before, a more conventional representation of the AND operation is given by a truth table and logic symbol shown in Figure 5.

As before, A and B may be taken to represent 8-bit numbers, and an example of such an AND operation is given in Figure 6. Your microprocessor's instruction set will include an AND command which takes two 8-bit words and ANDs them, as illustrated in Figure 6.

| A | B | A+B |
|---|---|-----|
| 0 | 0 | 0   |
| 0 | 1 | 1   |
| 1 | 0 | 1   |
| 1 | 1 | 1   |

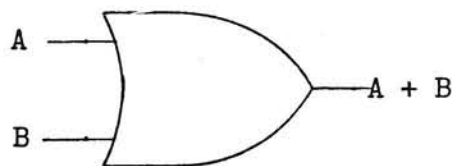

Figure 2: Truth Table and logic symbol for the OR operation.

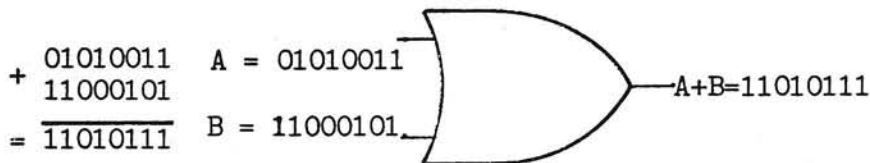

Figure 3: Example of an 8-bit OR operation.

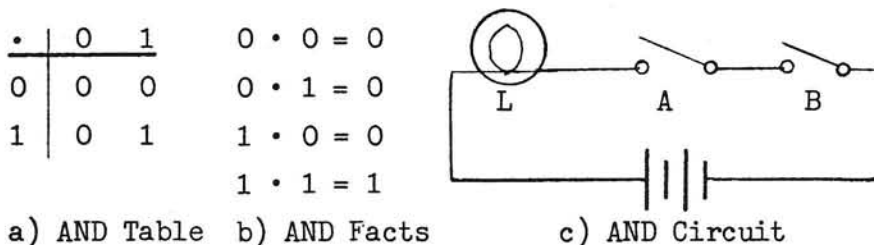

Figure 4: Summary of the properties of the AND operation.

| A | B | A • B |
|---|---|-------|
| 0 | 0 | 0     |
| 0 | 1 | 0     |
| 1 | 0 | 0     |
| 1 | 1 | 1     |

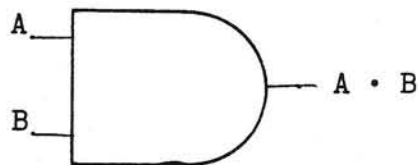

Figure 5: Truth Table and logic symbol for the AND operation.

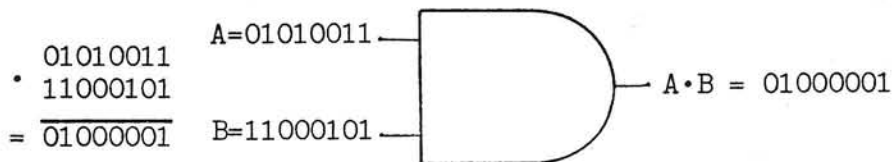

Figure 6: Example of an 8-bit AND operation.



Try the following AND problems where the 8-bit binary numbers have been represented in hex.

FF-11 = 11      33-BC =  
 7F-7F = 7F      00-3E =  
 0F-37 =          FO-37 =  
 80-FF =          80-11 =  
 55-40 =

### Everyone Loves a COMPLEMENT

There is another Boolean process called complementation or negation. It is a simple but very important idea. All complementation facts are summarized in Figure 7, using a truth table and the logic symbol. Clearly, complementation simply changes 0 to 1 and 1 to 0. The bar over the variable indicates complementation, and the inversion circle at the end of the triangle symbolizes complementation. A triangle without such a circle performs no inversion and in computer literature usually refers to a buffer.  $\bar{A}$  is read as "not A."

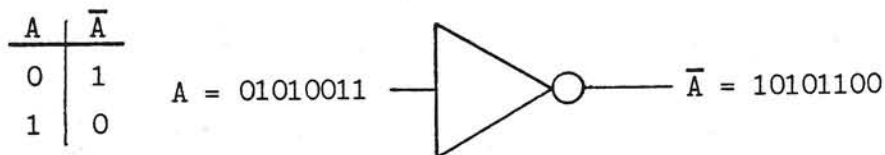

Figure 7: Truth Table and logic symbol for complementation.

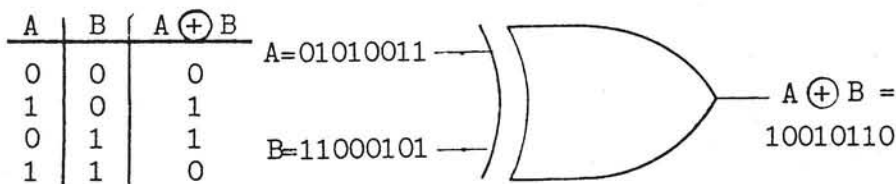

Figure 8: Truth Table and logic symbol for EOR operation.

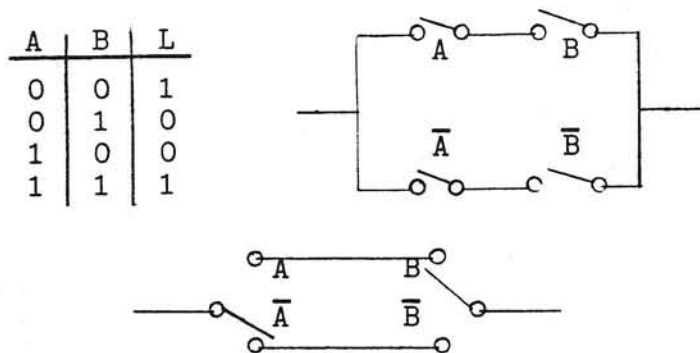

Figure 9: Truth Table and circuit diagram for the coin matcher.

### It's Not a Complement to be Called EXCLUSIVE

There is another operation in Boolean mathematics which is the exclusive or, which for our purposes we shall call EOR, and we shall give it the symbol  $\oplus$ . I didn't really lie to you in the second paragraph when I said there were only two operations. It turns out that the EOR operation can be accomplished with ORs and ANDs, but it is somewhat simpler to think of it as a third operation. Figure 8 gives the truth table for EOR, the logic symbol, and an example of an 8-bit computation. Later we shall see how it can be implemented with ORs and ANDs. Try some of the problems given earlier for OR and AND operations only do EOR operations. For example,  $FF \oplus 11 = EE$  and  $7F \oplus 7F = 00$ . Doing some EOR arithmetic may lead you to some interesting but important generalizations. In any case, in an EOR operation, if the digits are alike, the result is 0; but if the digits are different, the result is 1.

### If You're Exclusive You May Get A Complement

In checking over the instructions for my microprocessor, I find that no complementation command exists. Wow! Here is a fundamental Boolean concept which is missing. If you played with some EOR problems you may have already discovered how to produce a complement with the EOR operation. Suppose we deal with 1 digit numbers for the time being. Consider  $1 \oplus A$  for a starting problem. Clearly if A is 1,  $1 \oplus 1 = 0$  which is the complement of A. On the other hand, if A is 0, then  $1 \oplus 0 = 1$ , which is the complement of A. So both possibilities give the complement of A. Summarizing,

$$1 \oplus A = \bar{A} \quad (3)$$

If A is an 8-bit binary number represented by a hex number, equation (3) becomes  $FF \oplus A = \bar{A}$ . In other words, if you want the complement of a number, do an exclusive or with it and a word containing all ones.

### Designing Circuits — A Simple Application

You now know how to OR, EOR, AND and COMPLEMENT. You would like to know how to do something with what you have learned, right? Let's start with a simple problem; namely, constructing an electric coin flipping game. Actually, no coins will be flipped, but the principle is the same. Our machine will have two switches A and B. When the switches are the same a light will light, when they are different the light will be off. This, of course, corresponds to the case of both coins being the same (light on) or one coin coming up heads while the other comes up tails.

The first step in the design is to construct a truth table (sometimes called a closure table) for the system. We require that when A and B are both on the light is lit, when they are both off the light is lit, but when they have different settings (one on, the other off) the light is off. The truth table we would like to implement is clearly the one shown in Figure 9. This is constructed by first listing the four possible combinations for two switch settings, that is 00, 01, 10, and 11. For each of these switch settings the desired value of L is listed, completing the truth table. It is seen that when the switches "match" then  $L = 1$ , otherwise it is 0.

The next step in the design is to develop the Boolean equation which is equivalent to the truth table. This is accomplished by the following two steps:

1. Identify all rows with a 1 in the last column. AND the elements making up these rows, complementing those with a 0 in the row.

- OR the products obtained in step 1 and set the result equal to the variable in the last column.

For the first step above and the truth table of Figure 9, we obtain the products  $\bar{A} \cdot \bar{B}$  and  $A \cdot B$  from the first row and the last row, respectively. Step two then gives the equation,

$$\bar{A} \cdot \bar{B} + A \cdot B = L, \quad (4)$$

which is the equation for the circuit. It is important for you to verify, by substituting in the various values of A and B given in Figure 9, that this equation does not in fact give the desired values of L.

The final step in the design is to construct a circuit which is equivalent to the equation (4). An examination of this equation indicates that we need two parallel branches, one containing  $\bar{A}$  in the series with  $\bar{B}$ , the other containing A series with B. This circuit is shown in Figure 9. The battery and the light have been omitted for simplicity. Clearly the circuit could be constructed with two SPDT switches.

It is important to realize that the steps we took to design this particular circuit are perfectly general, that is, they are the same steps one would go through to design any logic circuit. Of course, with more switches the truth tables and the equations get more complicated. For example, with three switches our truth table would have 8 rows; four switches, 16 rows, and so on. Since this article is not meant to be an exhaustive (although you may feel that way) explanation of Boolean algebra, we will not proceed to more complex situations. For those you might want to pick up a textbook on digital electronics or computer science. But if you made it this far, you shouldn't have much trouble with the textbooks.

One other design study will illustrate several points. Suppose we require a logic 0 signal on a chip select pin when either of two other signals, call them A and B, are either both logic 0 or both logic 1. When A and B have opposite logic levels our chip select must be 1. This is clearly an artificial situation which originated in my mind and not in a computer interface circuit, but it illustrates a point. The truth table which fits the description demanded by the design is shown in Figure 10. Following the steps outlined earlier we find that the Boolean equation which implements the truth table is

$$\bar{A} \cdot B + A \cdot \bar{B} = CS. \quad (5)$$

An examination of the truth table will show that it is identical to the EOR table, and thus we have proved that EOR can be implemented with ORs and ANDs. A second point worth mentioning is that if A and B were single digit binary numbers,

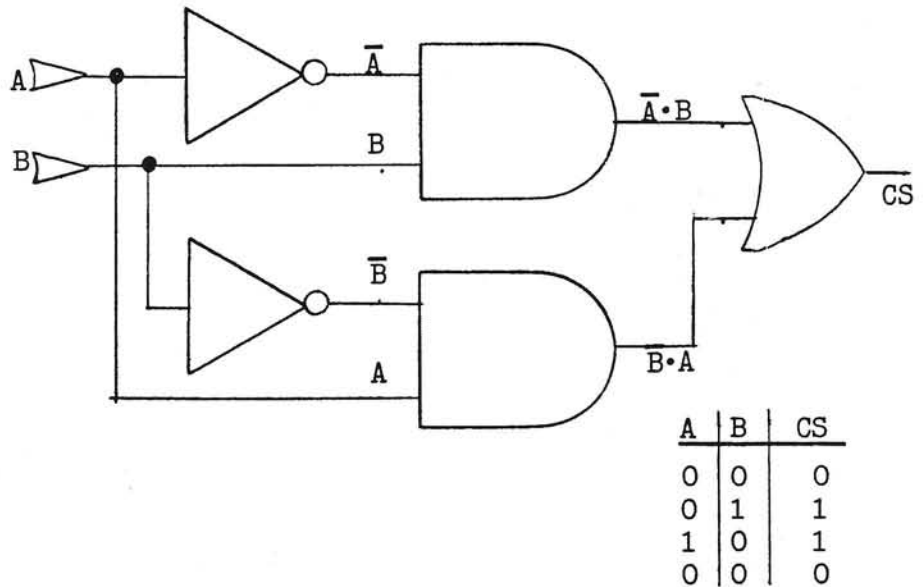

Figure 10: Truth Table and logic circuit for  $A \cdot B + A \cdot \bar{B} = CS$

the value of CS is the value of the least significant digit in the binary sum of A and B. Thus equation (5) is also part of an adding circuit. If A and B are ANDED the correct value for the "carry" part of the binary addition is also produced. Together these circuits form what is a "half adder." Figure 10 also gives the logic symbol implementation of equation (5).

#### TO BE OR $\bar{TO B} = 1$ : Some Boolean Theorems

Once a truth table, closure table, or function table has been constructed for a particular design problem and the Boolean equation has been derived using the steps outlined in the previous section, then one usually tries to simplify the equation to minimize the number of integrated circuits which will be required for the circuit. Here is where Boolean algebra really becomes useful, for it is the theorems of Boolean algebra which allow complex looking equations and circuits to be simplified.

$$\begin{array}{lll} 1 + A = 1 & 1 \cdot A = A & A + B = B + A \\ 0 + A = A & 0 \cdot A = 0 & \frac{A \cdot B}{\bar{A} + \bar{B}} = \frac{B \cdot A}{\bar{A} \cdot \bar{B}} \\ A + \bar{A} = 1 & A \cdot \bar{A} = 0 & \frac{A \cdot B}{\bar{A} \cdot \bar{B}} = \frac{B \cdot A}{\bar{A} \cdot \bar{B}} \\ A + \bar{A} = 1 & A \cdot \bar{A} = 0 & \frac{A \cdot B}{\bar{A} \cdot \bar{B}} = \frac{B \cdot A}{\bar{A} \cdot \bar{B}} \end{array}$$

$$\begin{array}{l} \bar{\bar{A}} = A \\ A \cdot B + A \cdot \bar{B} = A \\ A + A \cdot B = A \\ A + (B \cdot C) = (A+B) \cdot (A+C) \\ A \cdot (B+C) = (A \cdot B) + (A \cdot C) \end{array}$$

Table 1: Some Basic Theorems from Boolean Algebra

Because Boolean theorems are quite easy to understand and prove, and because they look different from the equations of real number algebra, a few of the simple theorems are listed in Table 1. An interesting property of Boolean algebra is illustrated by the first two columns. Note that column two can be obtained from column one by replacing all + signs with  $\cdot$ , if you replace all 1's with 0's.

It is quite easy and it is good practice to prove these theorems. They are proved by the method of exhaustion, namely all possible values for the variable are tried. For example, the first theorem can be proved by reasoning that A can be 1 or 0. If it is 1, then from the OR table  $1 + 1 = 1$ . If it is 0, then from the OR table  $1 + 0 = 1$ . So, for all possible values of A,  $1 + A = 1$  and the theorem is proved. All the theorems in the first two columns may be proved in this manner. Theorems involving two variable A and B are usually proved using the four possible values for

A and B, namely

A = 0011 = 03Hex

B = 0101 = 05Hex.

Theorems with three variables require 8 possible combinations to exhaust all the possible arrangements:

A = 10101010 = AA<sub>h</sub>

B = 11001100 = CC<sub>h</sub>

C = 11110000 = F0<sub>h</sub>

The purpose of expressing these in hex is so that you can try to prove the theorems on your computer, and at the same time get some experience in performing logical operations. All of the problems given earlier can also be solved on your computer. Theorems three and four in column three are the famous DE Morgan's theorems with which one can connect the ANDs and ORs with the NANDs and NORs of the real world.

To conclude, go back for a minute to that Boolean expression in the first paragraph. Suppose we ask what the value of Y will be if A and B are both 1. Using what you have just learned, the answer should be easy. If A and B are both 1 the AB (the dots are frequently omitted in AND operations) is 1. From the theorem in the first column of the theorem table it is clear that 1 OR anything is 1. Consequently, no matter what the other variables are, the value under the inversion or complementation bar is 1 if A and B are both 1. Inverting the 1 gives 0, so the answer is 0. Also if X = 1, then Y = 0, regardless of the states of the other variables.

I hope that you had some fun with this weird arithmetic. Perhaps your mind got bent out of shape as an added feature. But my main hope is that some of the mystery in those words "Boolean Algebra" has disappeared. I'll leave you with a homework problem. Draw the logic diagram to implement a full-adder, then expand it to handle 8-bit numbers. Finally, implement it with software on your 8-bit machine, and check your answer using the ADD instruction. Have some fun and get some books on digital electronics and/or computer science and dig into this stuff.

### Bibliography

*Digital Principals and Applications*, Malvino, A.P. and Leach, D.P., McGraw-Hill, 1975, New York.  
*Introduction to Computer Science* Scheid, F., Schaum's Outline Series, McGraw-Hill, 1970, New York.  
*The Bugbook V*, Rony, Peter R., Larsen, David G., and Titus, Jonathan A., E&L Instruments, Inc., Derby, Connecticut, 1977.

## DISK DRIVE WOES? PRINTER INTERACTION? MEMORY LOSS? ERRATIC OPERATION? DON'T BLAME THE SOFTWARE!



ISO-1



ISO-2

Power Line Spikes, Surges & Hash could be the culprit!  
 Floppies, printers, memory & processor often interact!  
 Our unique ISOLATORS eliminate equipment interaction  
 AND curb damaging Power Line Spikes, Surges and Hash.  
 \*ISOLATOR (ISO-1A) 3 filter isolated 3-prong sockets;  
 integral Surge/Spike Suppression; 1875 W Maximum load,  
 1 KW load any socket . . . . . \$54.95  
 \*ISOLATOR (ISO-2) 2 filter isolated 3-prong socket banks;  
 (6 sockets total); integral Spike/Surge Suppression;  
 1875 W Max load, 1 KW either bank . . . . . \$54.95  
 \*SUPER ISOLATOR (ISO-3), similar to ISO-1A  
 except double filtering & Suppression . . . . \$79.95  
 \*ISOLATOR (ISO-4), similar to ISO-1A except  
 unit has 6 individually filtered sockets . . . . \$93.95  
 \*ISOLATOR (ISO-5), similar to ISO-2 except  
 unit has 3 socket banks, 9 sockets total . . . \$76.95  
 \*CIRCUIT BREAKER, any model (add-CB) Add \$ 6.00  
 \*CKT BRKR/SWITCH/PILOT any model  
 (-CBS) . . . . . Add \$11.00

PHONE ORDERS 1-617-655-1532

**Electronic Specialists, Inc.**

171 South Main Street, Natick, Mass. 01760



Dept. mi

## FREE! up to \$170. in merchandise with purchase of PET-CBM item !!!

FREE MERCH

|                                  |        |                             |                 |
|----------------------------------|--------|-----------------------------|-----------------|
| PET 16K Large Keyboard           | \$ 995 | \$130                       |                 |
| PET 32K Large Keyboard           | \$1295 | \$170                       |                 |
| PET 8K Large Keyboard (New)      | \$ 795 | \$100                       |                 |
| PET 2040 Dual Disk (343K)        | \$1295 | \$170                       |                 |
| PET 2023 Printer (pres feed)     | \$ 695 | \$ 70                       |                 |
| PET 2022 Printer (trac feed)     | \$ 795 | \$100                       |                 |
| KIM-1                            | \$159  | (Add \$30 for Power Supply) | SYM-1 \$ 209.00 |
| AXIOM EX-801 Printer-PET         |        |                             | \$ 477.00       |
| 2114 L 450 ns                    | 5.35   | 24/4.95                     | 100/4.45        |
| 2716 EPROM (5 Volt)              |        |                             | 29.00           |
| 6550 RAM (for 8K Pet)            |        |                             | 12.70           |
| PET 4 Voice Music System (KL-4M) |        |                             | 34.50           |
| All Books and Software           |        |                             | 15% OFF         |
| Leedex Video 100 12" Monitor     |        |                             | 119.00          |



### ATARI — INTRODUCTORY SPECIAL

ATARI 400, Atari 800, and all Atari Modules 20% OFF.

|                                         |        |
|-----------------------------------------|--------|
| Heath WH-19 Terminal (fact. asm.)       | 770.00 |
| Programmers Toolkit - PET ROM Utilities | 44.90  |
| PET Word Processor - Machine Language   | 24.00  |



|                      |          |
|----------------------|----------|
| 3M "Scotch" 8" Disks | 10/31.00 |
| 3M "Scotch" 5" Disks | 10/31.50 |
| Verbatim 5" Disks    | 10/26.50 |
| Disk Storage Pages   | 10/ 3.95 |

SALE

Cassettes (all tapes guaranteed) Premium quality, high output low noise in 5 screw housing with labels: **AGFA PE 611**  
 C-10 10/5.95 50/25.00 100/48.00  
 C-30 10/7.00 50/30.00 100/57.00

Add \$1 per order for UPS shipping.  
 Ask for 6502, TRS-80, and S-100 Product List.

**A B Computers**

115 E. Stump Road  
 Montgomeryville, PA 18936  
 (215) 699-8386

# Our Latest Arrivals

Education, games, business, electronics—you'll find what you have been looking for in this batch of new programs from Instant Software.

**PET**\*

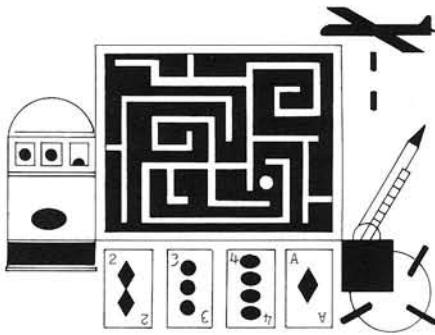

**PET DEMO I** You can give yourself, your family, and your friends hours of fun and excitement with this gem of a package.

- Slot Machine**—You won't be able to resist the enticing messages from this computerized one-armed bandit.
  - Chase**—You must find the black piece as you search through the ever-changing maze.
  - Flying Pheasant**—Try to shoot the flying pheasant on the wing.
  - Sitting Ducks**—Try to get your archer to shoot as many ducks as possible for a high score.
  - Craps**—It's Snake Eyes, Little Joe, or Boxcars as you roll the dice and try to make your point.
  - Gran Prix 2001**—Drivers with experience ranging from novice to professional will enjoy this multi-leveled race game.
  - Fox and Hounds**—It's you against the computer as your four hounds try to capture the computer's fox.
- For true excitement, you'll need a PET 8K. **Order No. 0035P \$7.95.**

**CODE NAME: CIPHER** Empires have risen and fallen because of secret codes and code breakers. Now you can enjoy that same feeling of intrigue and discovery with the Code Name: Cipher package. Included in the package are:

- Memory Game**—Would you like to match your memory against the computer's? You can with the Memory Game.
- Codemaster**—You and another player can compete to see who will be the "codemaster." One player types in a word, phrase, or sentence, and the PET

translates that message into a cryptogram. The other player must break the code and solve the cryptogram in the shortest time possible.

- Deceitful Mindmaster**—This isn't your ordinary Mastermind-type game. You must guess the five letters in the hidden code word. The computer will give you hints as to how close your guesses are.
- Code Breaker**—Cracking this code won't be as easy as cracking walnuts. You'll need to flex your mental muscles to win this game.

If you want a mental challenge, if you want to pit your wits against the faultless logic of the computer, then Code Name: Cipher is for you. For the 8K PET. **Order No. 0112P. \$7.95.**

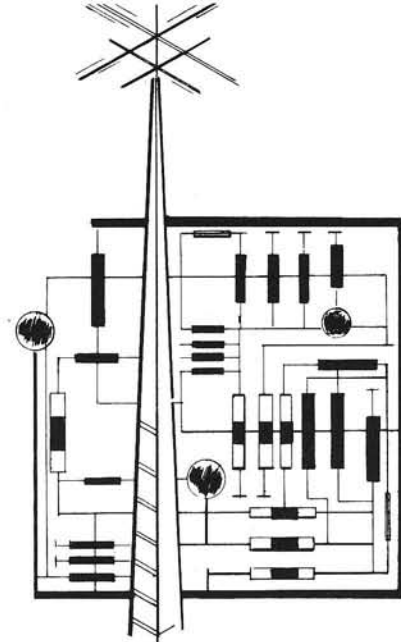

**HAM PACKAGE I** This versatile package lets you solve many of the problems commonly encountered in electronics design. With your 8K PET, you have a choice of:

- Basic Electronics with Voltage Divider**—Solve problems involving Ohm's Law, voltage dividers, and RC time constants.
- Dipole and Yagi Antennas**—Design antennas easily, without tedious calculations.

This is the perfect package for any ham or technician. **Order No. 0054P \$7.95.**



**DECORATOR'S ASSISTANT** This integrated set of five programs will compute the amount of materials needed to redecorate any room, and their cost. All you do is enter the room dimensions, the number of windows and doors, and the base cost of the materials. These programs can handle wallpaper, paint, panelling, and carpeting, letting you compare the cost of different finishing materials. All you'll need is a PET 8K. **Order No. 0104P \$7.95.**

**ACCOUNTING ASSISTANT** This package will help any businessman solve many of those day-to-day financial problems. Included are:

- Loan Amortization Schedule**—This program will give you a complete breakdown of any loan or investment. All you do is enter the principal amount, interest rate, term of the loan or investment, and the number of payments per year. You see a month-by-month list of the principal, interest, total amount paid, and the remaining balance.
- Depreciation Schedule**—You can get a depreciation schedule using any one of the following methods: straight line, sum of years-digits, declining balance, units of production, or machine hours. Your computer will display a list of the item's lifespan, the annual depreciation, the accumulated depreciation, and the remaining book value. This package requires the PET 8K. **Order No. 0048P \$7.95.**

**ELECTRONIC ENGINEER'S ASSISTANT** Now you can use your computer to analyze designs for filter circuits and microstrip transmission lines.

- Network Analysis**—Your computer can help you design and analyze four-terminal AC networks. Just enter the input load impedance, component values, and the frequency range. Your computer will analyze the circuit and display the gain, the real input impedance, and the imaginary input impedance throughout



## VAK-7 FLOPPY

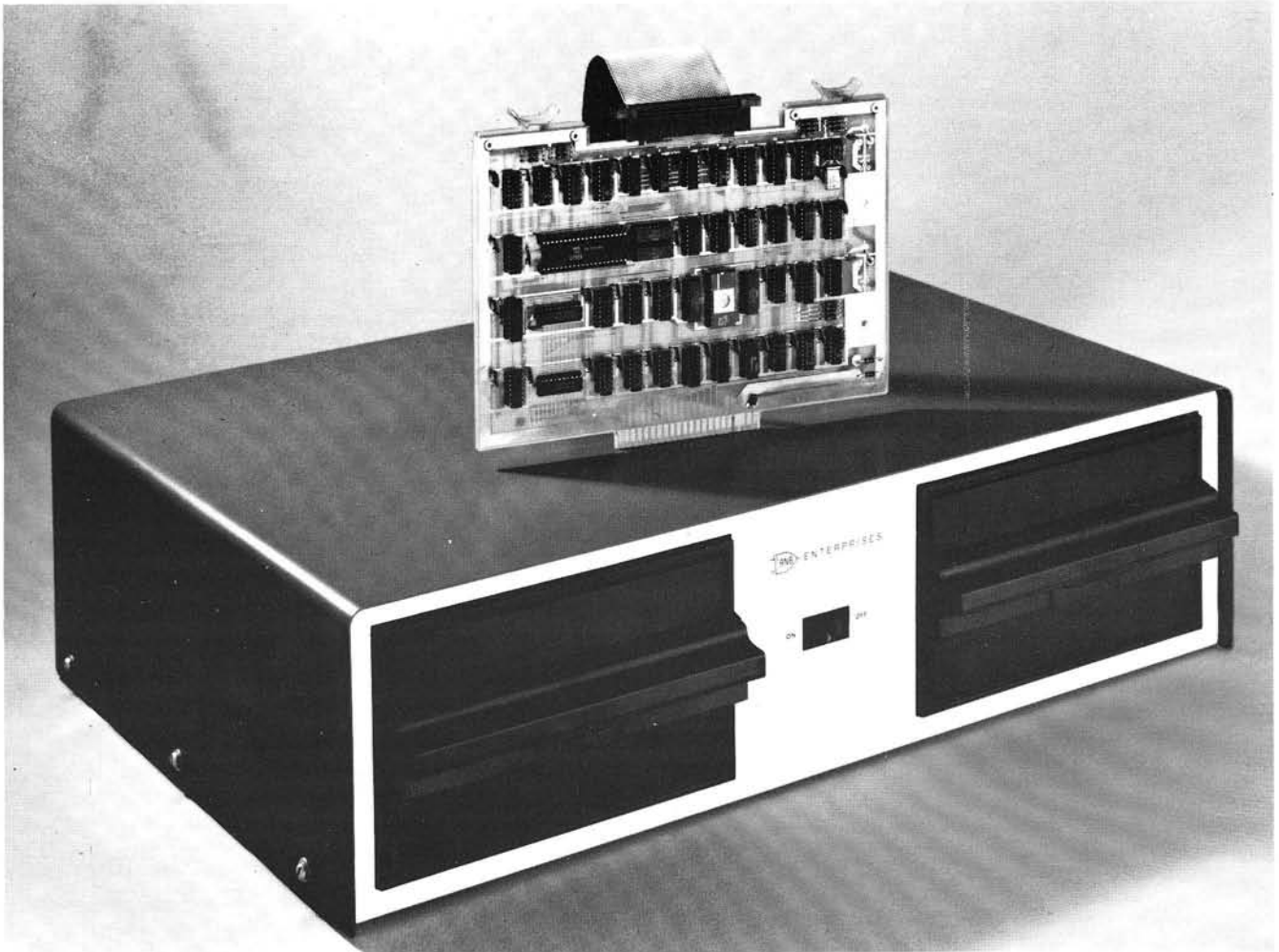

The VAK-7 Disk System was specifically designed for use with AIM-65, SYM-1, and KIM-1 Microcomputer Systems. The VAK-7 will plug directly into the VAK-1 Motherboard or with the addition of regulators into the KIM-4\* Motherboard. The VAK-7 is a complete full size (8") FLOPPY DISK SYSTEM. This system will READ, WRITE, and FORMAT both IBM SINGLE and DUAL DENSITY diskettes. Single-Sided is standard and Dual-Sided is optional. Our Single-Sided drives are set up so they can be converted at a later date to Dual-Sided by the factory, if your storage needs increase.

The VAK-7 system occupies a 4K address space. The system has a 1K block of D.M.A. RAM as a transfer buffer. Also, a 1K block of RAM reserved for D.O.S. pointers, drive status, and catalog information. The remainder of the address is occupied by the resident 2K MINI-DOS. This MINI-DOS is a complete set of subroutines to Read, Write, and Format.

# DISK SYSTEM

The MINI-DOS is not a high level Disk Operating System, but contains all the elementary subroutines for implementation of a high level DOS. Since all the functions are in subroutines, the implementation of this system into a dedicated system is simplified.

## MINI-DOS SUBROUTINES

|                        |                                  |
|------------------------|----------------------------------|
| Block Move             | Read/Write Deleted Data          |
| Seek Track             | Format Disk/Test For Bad Sectors |
| Recalibrate Disk       | Initialize Disk                  |
| Sense Interrupt Status | Physical Copy (Disk to Disk)     |
| Read/Write Data        | Self Test                        |

The VAK-7 is an interrupt driven system, which uses the  $\overline{IRQ}$  vector. Since this is an interrupt driven system, your system processor is only used to move data into or out of the 1K of DMA RAM, issue the command, and check status at the end of the disk operation. Your system processor is free to do other functions, during disk operations because the intelligent disk controller will complete the operation without tying up valuable processor time.

The VAK-7 System comes complete with Disk Controller Board, Interconnecting Cable, a Cabinet with Power Supply (for two Disk Drives) and one Disk Drive. The VAK-7 Controller can handle up to Four Drives.

## SPECIFICATIONS:

- Completely assembled, tested, and burned in.
- Occupies address \$9000-\$9FFF for AIM-65, \$9000-\$9FFF for SYM-1, or \$E000-\$EFFF for KIM-1.
- IBM Format; Single Density (128 bytes/sector); Dual Density (256, 512, or 1024 bytes/sector).
- All IC's are in sockets.
- Fully buffered address and data bus.
- Standard KIM-4\*BUS (both electrical pin-out and card size).
- Designed for use with a regulated power supply, but has provisions for adding regulators for use with an unregulated power supply.
- Dimensions: Board—10" wide x 7" high (including card-edge)  
Cabinet—23.5" wide x 6.5" high x 16" deep.
- Power Requirements: +5V DC @ 2 Amps.  
117V AC 60Hz @ 2 Amps.

\*KIM-4 is a product of MOS Technology/C.B.M.

## PRICE:

|                       |            |
|-----------------------|------------|
| Single-drive, 1-sided | \$1,299.00 |
| Dual-drive, 1-sided   | 1,898.00   |
| Single-drive, 2-sided | 1,499.00   |
| Dual-drive, 2-sided   | 2,398.00   |

|              | <u>Plus Shipping</u> | <u>UPS</u> | <u>Mail (APO, FPO)</u> | <u>International</u>                                |
|--------------|----------------------|------------|------------------------|-----------------------------------------------------|
| Single Drive | 12.00                |            | 32.00                  | Shipped Air Freight.<br>Freight charges<br>collect. |
| Dual Drive   | 16.00                |            | 44.00                  |                                                     |

For Alaska and Hawaii, use mail rates.

We manufacture a complete line of high quality expansion boards. Use reader service card to be added to our mailing list, or U.S. residents send \$1.00 (International send \$3.00 U.S.) for airmail delivery of our complete catalog.



2967 W. Fairmount Avenue  
Phoenix AZ 85017  
(602)265-7564



# *SUPER-TEXT*<sup>TM</sup>

## **STANDARD FEATURES**

- single key cursor control
- automatic word overflow
- character, word and line insertion
- forward and backward scrolling
- automatic on screen tabbing
- single key for entering "the"
- auto paragraph indentation
- character, word and line deletion
- ditto key
- multiple text windows
- block copy, save and delete
- advanced file handling
- global (multi-file) search and replace
- on screen math and column totals
- column decimal alignment
- chapter relative page numbering
- complete printer tab control
- line centering
- superscripting and subscripting
- displays UPPER and lower case on the screen with Dan Paymar's Lower Case Adapter

## **FAST EDITING**

Super-Text was designed by a professional writer for simple, efficient operation. A full floating cursor and multiple text screens facilitate editing one section of text while referencing another. Super-Text's advanced features actually make it easier to operate, allowing you to concentrate on writing rather than remembering complicated key sequences.

## **FLOATING POINT CALCULATOR**

A built in 15 digit calculator performs on-screen calculations, column totals and verifies numeric data in statistical documents.

## **EXCLUSIVE AUTOLINK**

Easily link an unlimited number of on-line files on one disk or from disk to disk. Autolink allows you to search or print all on-line files with a single command. Typical files of items that can be stored in this way include personnel files, prospect files, maintenance records, training records and medical histories.

# The Professional Word Processor

for the Apple II  
and the Apple II plus

**MUSE**<sup>TM</sup>  
THE LEADER IN QUALITY SOFTWARE

## **ADVANCED FILE HANDLING**

Single key file manipulation and complete block operations allow the user to quickly piece together stored paragraphs and phrases. Text files are listed in a directory with a corresponding index for fast and accurate text retrieval.

## **PRINTER CONTROLS**

Super-Text is compatible with any printer that interfaces with an Apple. Print single or multiple copies of your text files or link files and they will be automatically printed in the specified order. User defined control characters can activate most special printer functions.

## **MODULAR DESIGN**

This is a modularly designed system with the flexibility for meeting your future word processing needs. The first add-on module will be a form letter generator for matching mailing lists with Super-Text form letters. The form letter module will be available in the first quarter of 1980.

SUPER-TEXT, requires 48K (\$99.95)  
Available TODAY at Computer Stores  
nationwide. Dealer inquiries welcome. For more  
information write:

MUSE SOFTWARE 330 N. Charles Street Baltimore, MD 21201 (301) 659-7212



# Program Checksum Calculator

---

**Whenever you key in a program in machine code, there is some doubt as to whether or not it has been entered correctly. One minor error is all it takes to ruin a program. A technique and program is presented to help overcome this problem on any 6502 computer.**

---

Nicholas Vrtis  
5863 Pinetree SE  
Kentwood, MI 49508

I decided to write this program for selfish reasons. My hope is that everybody who transfers or writes programs for distribution will use it. The purpose of the program is to compute a sixteen bit checksum by adding up all the bytes in a program. This really isn't a totally new idea. Most methods of transferring programs or data external to a CPU use some sort of checksum routine. Even parity is really a one bit checksum. There is one major method of program transfer which makes almost no use of checksums. That method is listings published in magazines. One of the reasons is probably that noone has published a simple, general program to compute a checksum.

This program was written and tested on a SYM-1, but was designed to be as machine independent as possible. It should run on almost any 6502 system. There are only two monitor routines used, both of which are probably available in most monitors. The routine called OUT-BYT outputs the contents of the 'A' register as two HEX digits. Just in case this routine isn't readily available on your system, I have also included a version of one at the end of the program. OUTCHR is a routine that outputs the contents of 'A' as a character; and unless your are using the HEX output routine, it is only used to output a space as a separator. The pro-

gram does not assume that any registers are saved or restored by either monitor routine. It is completely relocatable (as is HEXOUT), and only uses four bytes of page zero memory. If you want to, you could even put it into an EPROM. The work area for the two byte checksum accumulator is obtained from the stack to avoid any more page zero requirements.

The theory and method of operation is simple. The starting address of the program to be summed is placed at locations \$00 and \$01 (low order first as usual). The ending address is placed at locations \$02 and \$03, and the program is started. The program will output an intermediate checksum after the end of each page of the summed program (i.e., each time the high order byte of the current address changes). This intermediate value would be useful in narrowing down the address of where a mistake lies. For a long program there might be a few of these intermediate sums; but then, that is also when they would be most helpful. Remember they still only narrow it down to 256 bytes (or less for the first and last values).

The program starts by zeroing the checksum accumulator by pushing two zero bytes onto the stack. The stack register then points to the next available stack location, which is actually \$100 plus the stack register value in absolute address terms. The checksum ac-

cumulator is therefore at locations \$101 and \$102 plus the stack register value, since the stack register starts at \$1FF and works toward \$100 each time a value is pushed onto the stack. Transferring the stack register to the 'X' register lets us add directly to these two bytes. It would be possible to accomplish the same thing with Pulls and Pushes, but wouldn't have been as interesting. For the output of the last checksum value, the values are Pulled from the stack to keep the stack register the same before as after.

In addition to the aforementioned selfish motives, I have found the program to have other more mundane uses around the computer room. If you suspect a program is modifying itself (possibly by accident), compute the checksum before and after execution. If the checksums are the same, you can be reasonably confident that the program hasn't changed. I say reasonably confident because a simple checksum is not total proof that a program didn't change. If I add to one location and subtract the same amount from another, the checksum will still come out the same. It is orders of magnitude more accurate than guessing or eyeballing a memory dump though.

By the way, the checksum for this program (\$04 to \$48) is \$1AAA! For the HEXOUT subroutine it is \$08F8.

```

0010:
0020:          SYM MONITOR ENTRY POINTS USED
0030: 0049   OUTBYT *      $82FA  OUTPUT °A° AS 2 HEX DIGITS
0040: 0049   OUTCHR *      $8A47  OUTPUT °A° AS ASCII
0050:
0060: 0000          ORG      $0000
0070:
0080: 0000 00   STRTAD =      $00   PROGRAM STARTING ADDRESS LOW
0090: 0001 00          =      $00   PROGRAM STARTING ADDRESS HIGH
0100: 0002 00   ENDAD =      $00   PROGRAM ENDING ADDRESS LOW
0110: 0003 00          =      $00   PROGRAM ENDING ADDRESS HIGH
0120:
0130: 0004 A9 00   PGMSUM LDAIM $00   ZERO CHECKSUM ON THE STACK
0140: 0006 48          PHA
0150: 0007 48          PHA
0160:
0170: 0008 BA   ADDIN  TSX          MOVE STACK POINTER TO INDEX
0180: 0009 A0 00   LDYIM $00   MAKE SURE Y REG IS ZERO
0190: 000B 18          CLC
0200: 000C B1 00   LDALY STRTAD GET A PROGRAM BYTE
0210: 000E 7D 02 01  ADCX $0102 ADD TO CHECKSUM
0220: 0011 9D 02 01  STAX $0102
0230: 0014 90 03   BCC  NOCARY
0240: 0016 FE 01 01  INCX $0101
0250:
0260: 0019 E6 00   NOCARY INC  STRTAD ADVANCE TO NEXT PROGRAM BYTE
0270: 001B D0 15   BNE  CHKEND GO CHECK FOR END OF PROGRAM
0280: 001D E6 01   INC  STRTAD +01 OTHERWISE BUMP TO NEXT PAGE
0290: 001F BD 02 01  LDAX $0102 OUTPUT INTERMEDIATE CHECKSUM ALSO
0300: 0022 48          PHA      SAVE LOW ORDER ON STACK
0310: 0023 BD 01 01  LDAX $0101 TO AVOID SAVING X
0320: 0026 20 FA 82  JSR  OUTBYT OUTPUT HIGH ORDER PART
0330: 0029 68          PLA
0340: 002A 20 FA 82  JSR  OUTBYT THEN LOW ORDER
0350: 002D A9 20   LDAIM $20  SPACE
0360: 002F 20 47 8A  JSR  OUTCHR AND A SPACE AS SEPARATOR
0370:
0380: 0032 A5 01   CHKEND LDA  STRTAD +01 CHECK IF TO END OF PROGRAM
0390: 0034 C5 03   CMP  ENDAD +01
0400: 0036 D0 04   BNE  CHKND
0410: 0038 A5 00   LDA  STRTAD
0420: 003A C5 02   CMP  ENDAD
0430: 003C 90 CA   CHKND BCC  ADDIN LESS MEANS MORE TO GO
0440: 003E F0 C8   BEQ  ADDIN
0450:
0460: 0040 68          PLA      ELSE GET HIGH ORDER OF CHECKSUM
0470: 0041 20 FA 82  JSR  OUTBYT ENO NEED TO PRESERVE THINGS
0480: 0044 68          PLA
0490: 0045 20 FA 82  JSR  OUTBYT
0500: 0048 00   BRK          CAUSE WE ARE DONE
0510:
ID=
HEXOUT  MICRO-WARE ASSEMBLER 65XX-1.0 PAGE 01

```

```

0010:
0020: 0200   HEXOUT ORG  $0200  RELOCATABLE
0030: 0200 48   PHA      SAVE EXTRA COPY FOR SECOND HALF
0040: 0201 4A   LSRA     SHIFT HIGH 4 BITS TO LOW ORDER
0050: 0202 4A   LSRA
0060: 0203 4A   LSRA
0070: 0204 4A   LSRA
0080: 0205 C9 0A  CMPIM $0A  CHECK IF >9
0090: 0207 90 02  BCC  HEXOTA WILL SET CARRY IF >=
0100: 0209 69 06  ADCIM $06  PLUS 7 WILL OFFSET TO GET ASCII °A°
0110: 020B 69 30   HEXOTA ADCIM $30
0120: 020D 20 47 8A  JSR  OUTCHR NOW OUTPUT THE FIRST HEX CHARACTER
0130: 0210 68          PLA      GET ORIGINAL BACK
0140: 0211 29 0F  ANDIM $0F  ONLY WANT 4 LOW ORDER BITS NOW
0150: 0213 C9 0A  CMPIM $0A  SAME CONVERT TO ASCII
0160: 0215 90 02  BCC  HEXOTB
0170: 0217 69 06  ADCIM $06
0180: 0219 69 30   HEXOTB ADCIM $30
0190: 021B 4C 47 8A  JMP  OUTCHR LET THIS GUY DO THE RETURN
0200:
ID=

```

## Classified Ads

SYM/KIM Appendix \$4.25 postpaid, (see MICRO, 19:68 for description). First bk. of KIM: \$10. Combo Appen. & 1st bk: \$13.50. SYM-1 Hardware Theory Manual supplements, SYM-1 Ref. Manual \$6.00. Order from:

Robert A. Peck  
P.O. Box 2231  
Sunnyvale, CA 94087

OSI C1P, 8K RAM; Setchell-Carlson monitor; G-E recorder; many games and utilities on tape. \$4.25 pp UPS. From:

G. Laverick  
Route 1  
Big Lake, MN 55309  
(612) 263-3829

Color Graphics for OSI C1P or Superboard II. Details on modifications enable operation in several color graphic modes. Easy installation. Includes colored-video game for demo, and checkout that runs on 4K RAM systems. Low-cost hardware not included. Send \$8.65 to:

Tom Hoffman  
873 Dorset Drive  
Knoxville, TN 37919

100 percent PET disk oriented Macro Assembler/Text Editor (MAE) Development software. Includes a new version of our ASSM/TED written specifically for the 32K new ROM PET and 2040 disk drive. Features macros, conditional and interactive assembly, and includes a relocating loader program. \$169.95 includes diskette and manual. Send \$1.00 for details.

Eastern House Software  
3239 Linda Drive  
Winston-Salem, NC 27106

ATTENTION SYM-1 OWNERS: Modify your SYM to have 8K of 2114 RAM on board with the W7AAY piggyback RAM board. Bare board plus instructions is \$5.00 (plus a self addressed, stamped envelope per board. The new W7AAY RAE-½ board plugs into and extends ROM socket p3 so that the two chip version of RAE only needs one SYM socket. Completely assembled, with instructions for \$10.00 postpaid in the USA. Order from:

John M. Blalock  
P.O. Box 39356  
Phoenix, AZ 85069

# Now You Can Have INPUT/OUTPUT For Your Apple Computer

DUAL AXIS JOY-  
STICK AND PUSH-  
BUTTON MOD-  
ULE for Games,  
Graphics, and  
Experimental Pro-  
gram Input

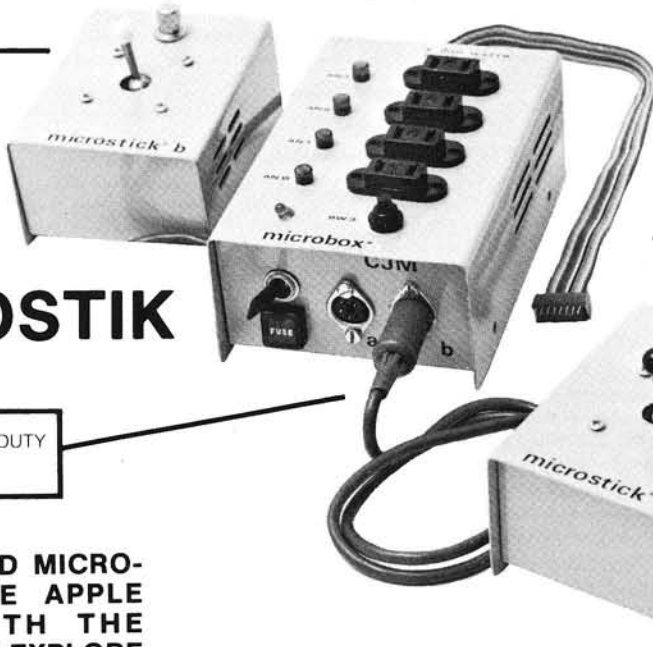

## MICROBOX

CONNECTS DIRECTLY  
to the Apple Game  
Socket. ACCEPTS 2  
Dual Axis MICROSTIKS  
or 4 Paddles

## MICROSTIK

EXTRA LONG, HEAVY DUTY  
cables and connectors

ISOLATED SWITCH-  
ING of 4 AC loads or  
relays from a basic  
program. 4 LED  
status indicators.  
Toggle Switch input  
(sw3)

**MICROBOX AND MICRO-  
STIK PROVIDE APPLE  
OWNERS WITH THE  
HARDWARE TO EXPLORE  
THE INPUT/OUTPUT CA-  
PABILITIES OF THEIR  
COMPUTERS.**

A SIMPLE COMMAND from the Apple keyboard or a Basic Program can switch an external device. Connect AC loads, such as lamps, motors, relays or solenoids directly through the MICROBOX's 4 AC OUTLETS. Loads can range from 0 to 220VAC and draw up to 200 Watts each. Solid State Switching ISOLATES the load from your Apple for complete safety. Four LEDs provide a visual on/off status of each load.

A Complete Instruction/Tutorial Manual is included with the MICROBOX.

### REAL-TIME INPUT

The MICROSTIK is a sturdy, two axis joystick. Metal Cable Connectors assure trouble free usage over time, and enable extension cables to be added easily. Use the MICROSTIK to add real-time input to your game, graphic or experimental programs. Each MICROSTIK contains a PUSHBUTTON for added input possibilities.

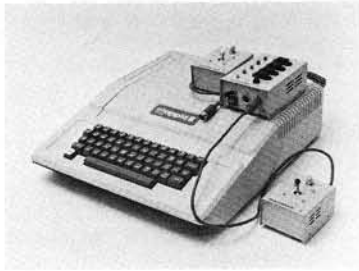

MICROBOX and MICROSTIK sit comfortably on, or aside the Apple Computer. They have been designed to match the Apple in color and design.

### ORDER TODAY AND CON- NECT YOUR APPLE TO THE OUTSIDE WORLD.

The MICROBOX and MICRO-  
STIK can be purchased at  
most computer stores or can  
be ordered directly by mail or  
through our convenient 24  
hour telephone service.

TELEPHONE:  
(703) 471-4291

Order the MICROSET and  
receive the MICROBOX, 2  
MICROSTIKS, the Manual  
and Cassette, and SAVE \$25.

|                           |                 |
|---------------------------|-----------------|
| <b>MICROBOX</b>           | <b>\$109.95</b> |
| <b>MICROSTIK (each)</b>   | <b>34.95</b>    |
| <b>Demo Cassette</b>      | <b>9.95</b>     |
| <b>MICROSET</b>           | <b>164.95</b>   |
| <b>12 ft. Ext. Cables</b> | <b>6.95</b>     |
| <b>Relay Modules</b>      | <b>WRITE</b>    |
| <b>Solenoid Modules</b>   | <b>WRITE</b>    |

Va. residents add 4% sales tax

MASTER CHARGE, VISA accepted  
NO C.O.D.s

CJM Industries, Dept. MB  
316B Victory Drive  
Herndon Industr Park  
Herndon, Va. 22070



# Ask the Doctor

---

**A technique to solve a problem in the AIM TTY service and a program for easy tape retrieval on the KIM are presented.**

---

Robert M. Tripp  
The Computerist, Inc.  
P.O. Box 3  
S. Chelmsford, MA 01824

The Serial TTY port on the AIM 65 works in a very similar fashion to that of the KIM described by Ben Doure in MICRO issue number 12, May, 1979. The instructions for achieving synchronization at any baud rate (bits per second) are to switch the slide key from KB (keyboard) to TTY (Teletype), next press RESET and type DELETE on the teletype. The routine DETCPS measures the duration of the start bit and since the start bit is at logic level zero, then DELETE is a suitable character to use, because it consists of eight logic 1 signals following the start bit. Actually, about half of the characters on the keyboard would do just as well provided they *start* with a logic level 1 after the start bit. (Note the least significant bit is transmitted first.) The duration of the start bit is stored in CNTH 30 and CNTL 30 as explained previously.

An ordinary teletype works at 110 baud, but I have available a VDU which has a baud rate switch and will work at 110, 300, 600, 1200, 2400, 4800 baud. I tried all the rates with the AIM 65 hooked up and they worked perfectly, except for the 1200 baud. At this rate, no synchronization was achieved and only garbled rubbish appeared on the screen. This was of some concern to me because it was my intention to set up a three-way link between the VDU, the AIM 65 and a PRIME 400 computer and the PRIME was to operate *only* 1200 baud.

On pages 9-29 of the AIM 65 User's Guide the contents of CNTH 30 (at \$A417) and CNTL 30 (at \$A418) are listed

for several baud rates. It is essential that the correct values can be entered by hand if synchronization does not work. The values quoted are only approximate, because the on-board crystal will not be exactly 4 M Hz and the devices linked up may vary slightly in baud rate. A check at the rates that did synchronize, showed some slight differences. Entering the values suggested for 1200 baud, namely, \$02 for CNTH 30 (high byte) and \$FD for CNTL 30 (low byte), produced perfect functioning of the VDU.

The Monitor Program Listing, page 10, shows that the programming between locations \$E11B and \$E144 times the start bit, using the timer T2 in the 6522 VIA dedicated to the monitor. The timer is started when the input goes low (start of bit) and when it goes high again (end of bit), the high byte count is read first and slightly later then the low byte count. The counter T2 counts downwards and the counters are initialized with \$FF in both. The latch for T2 has \$FF put into it permanently during initialization at reset, shown at program addresses \$E067 to \$E0D0. The value \$FF is written into the high byte count at program address \$E126, which also writes the latch value into the low byte count.

When the counter is read, the high and low bytes are complimented with \$FF to get the duration of a bit in multiples of 1  $\mu$ S. The counter start is delayed slightly by the time taken by the program instructions \$E110 to \$E126 and the low byte reading is delayed after the end of the start bit between instruc-

tions \$E 129 and \$E 136. Thus the count is too high and evidently requires reducing by 44 (decimal). This is carried out by the routine PATCH 1 at program address \$FE 7C. If the low byte count happens to be less than 44 (it is, only for the 1200 baud rate), then the high byte count will require reducing by one also.

The carry bit is set correctly before the SBC instruction for 44. Unfortunately, the fault is that the carry bit is never examined to see if it is unset and then CNTH 30 reduced by one, either in the subroutine or back in the main program. Programming could be written by a user to overcome this problem, but it is not really worth the effort of loading. The simplest course is to attempt the synchronization, switch back to the AIM keyboard, then change \$A417 from \$03 to \$02 using the M instruction. This gives the optimum count for the particular device connected to the serial interface.

On attempting the automatic synchronization at 1200 baud the values obtained for CNTH 30 and CNTL 30 were respectively \$03 and \$FO. The high byte value is different enough to cause the timing of each bit to be about 33 percent high, so the bits could not possibly be recognized by the VDU. I decided to investigate the reason for this, in case the VDU was faulty.

Roger Heal  
Department of Chemistry  
University of Salford  
Salford, M5 4WT  
England

### Fast Tape Retrieval

Although I use the routine primarily for data retrieval for the TVT-6 video interface, it can readily be adapted for many other applications. Basically, it works as follows:

**Press Start:** Tape recorder starts and tape is read. When seven segment display reads 0000 A9, then

```

0000 A9 01      GO      LDAIM $01      TURN TAPE OFF
0002 4D 03 17      EOR   $1703    BY TOGGLING CONTROL BIT
0005 8D 03 17      STA   $1703
0008 4C AD 17      JMP   SCAN      JUMP TO SOME PROGRAM
    
```

### Fast Tape Retrieval

Although I use the routine primarily for data retrieval for the TVT-6 video interface, it can readily be adapted for many other applications. Basically, it works as follows:

**Press Start:** Tape recorder starts and tape is read. When seven segment display reads 0000 A9, then

```

000B A9 01      ST      LDAIM $01      ST INTERRUPT
000D 4D 03 17      EOR   $1703    TURN TAPE ON
0010 8D 03 17      STA   $1703    BY TOGGLING CONTROL BIT
0013 4C 73 18      JMP   $1873    JUMP TO TAPE READ
    
```

```

17FA 0B      =   $0B      POINT TO 000B
17FB 00      =   $00      FOR ST KEY
    
```

**Press GO:** Tape recorder stops and the information from tape is displayed on a monitor. For next display file, again

**Press Start,** and so forth.

This provides a two button data retrieval system. The files on tape consist of ASCII data loaded into 0200 to 03FF. This, of course, can vary for other applications and could contain any type of data which would not interfere with the program located at the bottom of page zero. A small gap between files is convenient.

**Hardware Interface:** Consists of the relay circuit shown in figure 1. PB0 is used as the control port. The tape recorder must be set in the **PLAY** position.

**Software Interface:** Several items must be inserted memory in order to bring up the system. First, if used with the TVT-6, the SCAN program must be loaded beginning at 1780. Next, 17F9 must contain 00. This will allow continual reading of files without regard to ID numbers. Finally, the NMI vector must be entered:

```
17FA 0B and 17FB 00
```

The program utilizes the fact that on a proper tape read, the monitor returns at location 0000 XX. Now, 0000 is a memory location - a location which can be programmed like any other. I use this location to begin the tape/stop/display program. The **ST** button provides an **NMI** which points to the tape/start/read program.

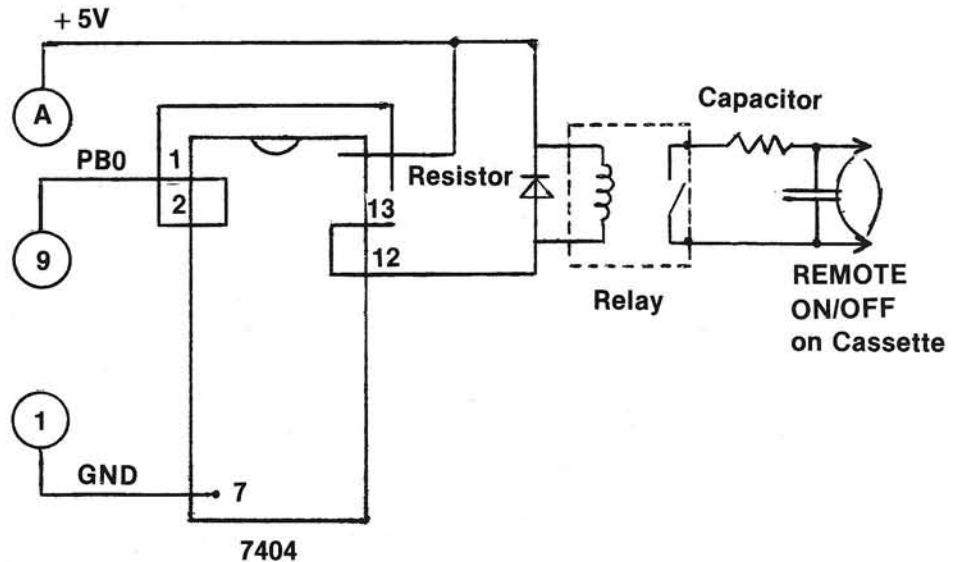

Ronald Kushnier  
3108 Addison Court  
Cornwells Heights, PA 19020

**ASK the DOCTOR** is presented as an opportunity for you to get information about the AIM, SYM, or KIM out to your fellow computerists. If you have a major article, a good program, a discussion of various features, or whatever, that is long enough for an article, then by all means, submit it as an article and get paid! If, however, you have some short comments, ideas, facts, warnings, etc. that you feel others will be interested in, but which are too short for an entire article, then send them to: ASK the DOCTOR, P.O. Box 6502, Chelmsford, MA 01824. You will not get paid for these "tidbits", but you will get full credit for them.



BOX 120  
ALLAMUCHY, N.J. 07820  
201-362-6574

HUDSON DIGITAL ELECTRONICS INC.

## THE HDE DISK SYSTEM.

### HERE'S WHAT ONE USER HAS TO SAY . . .

REPRINTED BY PERMISSION FROM THE 6502 USER NOTES - ISSUE NO. 14

PRODUCT REVIEW of the HDE DISC SYSTEM by the editor.

A number of you have asked for details about the HDE full size disc system.

The system is based around the SYKES 8" drive with the 6502 based intelligent controller.

This drive is soft sectored, IBM compatible, and single density which lets you store about a quarter megabyte of data on a disc.

The system software, called FODS (File Oriented Disc System), manages sequential files on the disc much the same way files are written on magnetic tape - one after another. When a file is deleted, from a sequentially managed file system, the space that the file occupied is not immediately reallocated, as in some disc operating systems. As it turns out, this can be an advantage as well as a disadvantage since deleted files on the FODS system can be recovered after the file has been deleted. (This has saved my sanity more than once!) Of course when you want to recover some of the disc space taken up by a number of these deleted files, you can simply re-pack or compress the disc and all the active files will be shifted down until there are no deleted files hanging around using up space.

FODS has this ability to repack a disc. When saving and loading in FODS you work with named files, not track and sector data or I.D. bytes. This makes life a lot easier. I've seen some disc systems where you have to specify track and sector info and/or I.D. bytes. What a pain that can be!

If you just want to save a source file temporarily, you can do that on what's known as "scratch-pads". There are two of these on a disc. "scratch-pad A" and "scratch-pad B", each of these temporary disc files can hold up to 16K or if "B" is not used, "A" can hold one file up to 32K in length. The only files that can be temporarily saved on scratch pad are files that have been built using the system text editor.

Being a dyed in the wool assembly language programmer, I really appreciate the FODS text editor! This line oriented editor is upwards compatible with the MOS/ARESCO editor but includes about everything you could ask for in a line editor. There is a full and semi-automatic line numbering feature, lines can be edited while they are being entered or recalled and edited later, strings can be located and substituted, the line numbers can be resequenced, the file size can be found, the hex address of a line can be known and comments can be appended to an assembly file after it has been found correct. Oops! I

forgot to say lines can also be moved around and deleted. This isn't the complete list of FODS editor commands, just the ones that immediately come to mind.

Another very powerful feature of the system is the ability to actually execute a file containing a string of commands. For example, the newsletter mailing list is now being stored on disc. When I want to make labels, I would normally have to load each letter file and run the labels printing program. But with FODS, I can build up a "JOB" file of commands and execute it.

The job file in turn calls each lettered label file in and runs the label printer automatically. The way computers are supposed to operate right?

Here's a listing of the job file I use to print mailing labels:

```
:LIS PRTLBL
0005 LOD A:RUN %LABEL:LOD B:JMP.E000:
LOD C:JMP.E000:
0010 LOD D:JMP.E000:LOD E:JMP.E000:
LOD F:JMP.E000:
0015 LOD G:JMP.E000:LOD H:JMP.E000:
LOD I:JMP.E000:
0020 LOD J:JMP.E000:LOD K:JMP.E000:
LOD L:JMP.E000:
0025 LOD M:JMP.E000:LOD MC:JMP.E000:
LOD N:JMP.E000:
0030 LOD O:JMP.E000:LOD P:JMP.E000:
LOD R:JMP.E000:
0035 LOD S:JMP.E000:LOD T:JMP.E000:
LOD V:JMP.E000:
0035 LOD S:JMP.E000:LOD T:JMP.E000:
LOD V:JMP.E000:
0040 LOD W:JMP.E000:LOD XYZ:JMP.E000:
0045 LOD EXCH:JMP.E000:LOD COMP:
JMP.E000:
```

Remember the MOS/ARESCO assembler I reviewed several issues ago? Well HDE went and fixed up all the problem areas that I mentioned in the review and then took it several steps further. The HDE assembler is an honest to goodness two-pass assembler which can assemble anywhere in memory using multiple source files from the disc. The assembler is an optional part of the system.

If you're the kind of person (as I am) who enjoys having the ability to customize, modify, and expand everything you own - you'll enjoy the system expansion abilities FODS has to offer. Adding a new command is as simple as writing the program, giving it a unique three letter name and saving it to disc. Whenever you type those three letters the system will first go through its own command table, see that its not there and then go out

and read the disc directory to see if it can find it. If it's on the disc it will read it in and execute it. Simple right? I've added several commands to my system and REALLY appreciate having this ability. Some of the things I've added include a disassembler, an expanded version of XIM (the extended machine language monitor from Pyramid Data), Hypertape, and a number of system utilities which make life easier. By the way, to get back to the system, all you need to do is execute a BRK instruction.

HDE also provides a piece of software that lets you interface Microsoft 9 digit BASIC to their disc system. The software allows you to load the BASIC interpreter itself from disc as well as saving and loading BASIC Programs to and from the disc. This particular version of the software doesn't allow for saving BASIC data but HDE mentioned that this ability may be possible with a future version.

The first thing I do with a new piece of software after I get used to using it is try to blow it up. I did manage to find a weak spot or two in the very first version of FODS (a pre-release version) but the later, release version has been very tight.

The standard software that is included with the system consists of the disc driver software, the system text editor and the BASIC software interface. Several command extensions may also be included. All the necessary stuff like a power supply, the KIM-4 interface card, and all cables and connectors are included. It took me about 45 minutes to get things up and running the first time I put the system together.

Admittedly, a dual full size disc system from HDE is probably beyond the means of most hobbyists but if you or your company is looking for a dynamite 6502 development system, I would recommend this one. I've used the Rockwell System 65 while I was at MOS and feel that dollar for dollar, feature for feature, the HDE system comes out on top. The only place the HDE system falls short when stacked up next to the System 65 is in the area of packaging. At this point, there is no cabinet for the disc drives available from HDE.

So far, I've got nothing but good things to say about HDE and their products. Everything I've received from them has been industrial quality. That includes their documentation and product support. I'm very impressed with what I've seen from this company so far and quite enthusiastic over what my KIM has become since acquiring the disc system and its associated software.

ERIC

**THANK YOU MR. REHNKE!**

**HDE PRODUCTS - BUILT TO BE USED WITH CONFIDENCE**

**AVAILABLE DIRECT OR FROM THESE FINE DEALERS:**

JOHNSON COMPUTER  
Box 523  
Medina, Ohio 44256  
216-725-4560

ARESCO  
P.O. Box 43  
Audubon, Pa. 19407  
215-631-9052

PLAINSMAN MICROSYSTEMS  
Box 1712  
Auburn, Ala. 36830  
800-633-8724

LONE STAR ELECTRONICS  
Box 488  
Manchaca, Texas 78652  
612-282-3570

PERRY PERIPHERALS  
P.O. Box 924  
Miller Place, N.Y. 11764  
516-744-6462

# Clocking KIM

---

**While you probably are not going to use your \$180 KIM to replace your \$18 digital clock, a lot can be learned about proper use of the KIM and 6502 by building a clock as an exercise. This example includes use of the IRQ interrupt, driving the display, and calculating time. The program is intentionally NOT optimized, providing a challenge for the reader.**

---

Ronald A. Guest  
12153 Melody Drive, 204  
Denver, CO 80234

When I first laid eyes on KIM, something inside my head screamed out at me. It said, "That six digit display was just made to be a clock display." Not being the type of person who likes getting yelled at, I decided to look into the idea.

The idea may seem trivial or worthless, but the design of a clock program is both challenging and educational. When I first started this project I had only owned my KIM-1 slightly more than a month, and I had not made use of some of the KIM's features (such as the interval timer and interrupt capabilities). I had read the MOS Technology manuals carefully, but some things had to be learned the hard way - like the fact that decimal mode does not effect increments and decrements, PB7 of the 6530-03 must be wired to IRQ on the 6502 by the user, and how to use the KIM's displays. I learned through experience.

A clock program is not totally useless, either. Outside of being a good program for keeping the processor busy, it also could be valuable when run with other programs. If, for instance, you had your KIM connected to an A/D converter, the clock program would enable you to take readings at specified times during the day. Or, when you are going to be away from home, your microprocessor could turn lights, radios, etc. on and off as a deterrent to burglary. And, if you had to scrape together your last dollar to buy

your KIM, and the old alarm clock just croaked, you can build an alarm to hang on your micro with parts from your tool box (see KIM-1 manual, page 57). You would then be the proud owner of the most intelligent alarm clock on the block.

A project such as this is an excellent way to become familiar with the features of your microprocessor. And, although there are several obstacles to be overcome, none are too difficult to surmount, given a little thought. The following discussion, intended for the KIM-1 could also serve as a guide for the development of a clock program on a similar system.

The first difficulty encountered in designing a clock program is a parallel processing problem: how to scan a display (or execute some other process) while at the same time, count the microseconds as they whiz by. Parallel processing on the KIM-1 can be achieved by the use of the 6502's interrupt capabilities. And since one of our processes is a simple counting mechanism, we can use the interval timer on the 6530-03 as our second "processor". The next two problems revolve around the interval timer.

The KIM's interval timer is only capable of timing intervals of 0.261102 seconds or less (with a 1MHz crystal). Problem number two results because of this. We need to simulate, through software, an interval timer able to time inter-

vals of up to one second. This can be accomplished by writing a value(s) into the interval timer until a certain number of interrupts has occurred, and then updating the time. But, it is not quite that simple.

Which brings us to problem number three. We want to be as efficient as possible, which means we want to interrupt normal processing as little as possible. Thus, as large a value as possible should be written into the timer. The problem, the most difficult of all, is; what value(s) to write where, and how many times. The discussion must now become a little more detailed. Keeping efficiency in mind, we want to delay the maximum value between interrupts as many times as possible, without exceeding one second. This means that we should write a \$FF into the +1024 location three times. This will give a delay of  $(3 * 255 * 1024) \mu s$ , or 0.216640 seconds less than one  $(1 - 0.783360)$ .

As you can see, this value is less than the maximum interval. The largest value, less than 0.216640 seconds, that we can write to the interval timer is  $(211 * 1024) \mu s$ , or 0.216064 seconds. About now you are probably thinking, "Oh! Holy Bit Bucket, will this never end?" But don't fuse a power supply, this tedious process is coming to an end. Now, let's see. If we write a 9 into the +64 location, that will give us a delay of  $576 \mu s$ , and a grand total of exactly one second. Success! We have accomplished our task. But, wait. We've

got some software overhead to consider, right? Right. The software which simulates this interval timer, and the software which updates the time must be taken into consideration. The amount of time allocated to the execution of this software will vary slightly for different programs. But  $32\mu\text{s}$  seems to be a sufficient amount of time. So we want our final delay to be  $544\mu\text{s}$  (instead of 576). We can easily achieve this by writing 68 into the +8 location.

What do we have so far? We have three delays of  $(255 \cdot 1024)\mu\text{s}$ , one delay for  $(211 \cdot 1024)\mu\text{s}$ , and one delay of  $(68 \cdot 8)\mu\text{s}$ ; giving us a grand total of  $999,968\mu\text{s}$ . (Although not the only combination of intervals which yield one second, this is the most efficient from the standpoint of the interrupted process.) Now, we need to take a look at the software necessary to simulate this timer.

The code needed to simulate a one second interval timer is given in listing 1. The first section of code gives us the delay of  $(3 \cdot 255 \cdot 1024)$ , assuming that "NUMDLY" is initialized to one (1). The second group of instructions gives the delay of  $(211 \cdot 1024)$ , and the third group gives the delay of  $(68 \cdot 8)$ . To assure that your clock program will be accurate, you should determine how much time your software will actually require. When calculating the amount of software overhead for your particular program, remember that the execution time of instructions executed after the timer has been written into, should not be included. This is because the timer will have already started counting down, resulting in an overlap of the countdown and instruction executions. Taking Listing 1 as an example, and assuming "NUMDLY" is less than three (3), all instructions before "INCDLY" should be included, but the increment and restore instructions should not be, since they are executed after the timing begins.

The code in Listing 1 would be contained in an interrupt program, which consists of instructions to do the following;

1. save all registers on the stack,
2. determine if one second has elapsed, if not then (5), else,
3. add one second to the time,
4. reset "NUMDLY" and the timer, and,
5. restore the registers from the stack.

A block diagram of the process is given in Figure 1. The coding for the inter-

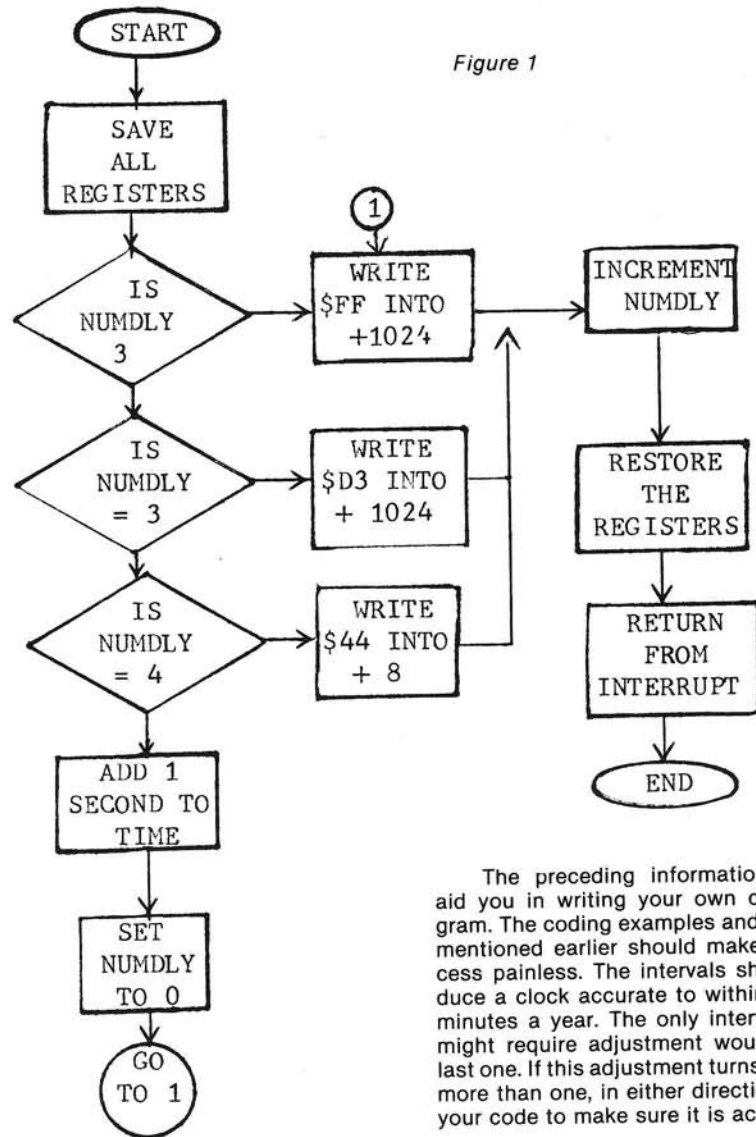

rupt program occupies about 96 bytes of memory (most of it is used to update the time).

The updating code must:

1. add 1 to the seconds, if not 60 then (4), else zero seconds and
2. add 1 to the minutes, if not 60 then (4), else zero minutes and
3. add 1 to hour, if 13 (or 25 for a 24 hour clock) set hour to 1, else
4. continue.

Since time uses decimal digits, it is necessary to load the byte into the accumulator and perform an add; an increment would not be decimal. The code to update the seconds is given in Listing 2 as an example.

The preceding information should aid you in writing your own clock program. The coding examples and intervals mentioned earlier should make the process painless. The intervals should produce a clock accurate to within about 5 minutes a year. The only interval which might require adjustment would be the last one. If this adjustment turns out to be more than one, in either direction, check your code to make sure it is accurate.

Let me mention a few more things to help you avoid trouble. Don't forget that any program which is to run coincidentally with the clock program you must initialize the interval timer and counter (NUMDLY) at the outset. Also, after you have loaded the clock program into memory, you must also store the starting address of the program in the IRQ interrupt vector locations. And, last but not least, connect the PB7 pin of the 6530-03 to the IRQ pin of the 6502 (A-15 to E-4).

The clock program I have described contains the basic features of any digital clock. It could be expanded to keep track of the month, day, year, and/or just about anything else you could want. If you are willing to spend the time, the clock can be as accurate as the hardware will allow. Theoretically, my clock program should be accurate to within less than 2 minutes a year. In practice, I set the program by WWV and let it run for three days straight. At the end of this time, the seconds were



still clicking by, right on the nose. This should be enough accuracy for all but the most exacting and finicky of home-

brewers. (I hope no one is going to run their clock program for a solid year.) Hopefully, the information information in

this article, and the program itself, will be as useful to others as it has been to me. Good Luck!!

Listing 1

```

0010:      INTERRUPT SERVICE ROUTINE TO RUN A REAL-TIME
0020:      CLOCK ON A MCS TECHNOLOGY KIM-1.
0030:
0040:      WRITTEN BY : RONALD A GUEST.
0050:
0060:      COPYRIGHT 1976 BY RONALN A. GUEST
0070:
0080: 0020          ORG      $0020
0090:
0100: 0020          NUMDLY *    $000D
0110: 0020          SECNDS *    $000C
0120: 0020          MINUTS *    $000B
0130: 0020          HOURS   *    $000A
0140:
0150: 0020 48          PHA             SAVE REGISTERS ON STACK
0160: 0021 8A          TXA             .
0170: 0022 48          PHA             .
0180: 0023 98          TYA             .
0190: 0024 48          PHA             ..
0200:
0210:      DELAY DETERMINED BY VALUE IN NUMDLY.
0220:      IF DELAY IS < 3 THEN DELAY 255 * 1024
0230:
0240: 0025 A5 0D          LDA      NUMDLY
0250: 0027 C9 03          CMPIM   $03
0260: 0029 10 0A          BPL     DELAYF
0270:
0280: 002B A9 FF          MAXDLY LDAIM  $FF
0290: 002D 8D 0F 17       STA     $170F
0300:
0310: 0030 E6 0D          INCPLY INC    NUMDLY INCREMENT COUNT AND GO RESTORE
0320: 0032 4C 80 00       JMP     RESTOR ..
0330:
0340:      IF NUMDLY <> 3 BRANCH TO ONETST
0350:
0360: 0035 D0 08          DELAYF BNE    ONETST
0370: 0037 A9 D3          LDAIM  $D3   IF = 3 THEN DELAY 211*1024
0380: 0039 8D 0F 17       STA     $170F
0390: 003C 4C 30 00       JMP     INCPLY
0400:
0410:      IF NUMDLY > 4 THEN ONE SECOND HAS ELAPSED
0420:
0430: 003F C9 04          ONETST CMPIM  $04
0440: 0041 D0 08          BNE    ONESEC
0450: 0043 A9 44          LDAIM  $44   IF = 4 THEN DELAY 68*8
0460: 0045 8D 0D 17       STA     $170D
0470: 0048 4C 30 00       JMP     INCPLY
0480:
0490:      ONE SECOND HAS ELAPSED, SO, INC STORED TIME
0500: 004B F8          ONESEC SED     USE DECIMAL MATH.
0510: 004C A5 0C          LDA     SECNDS SET SECONDS BYTE
0520: 004E 18          CLC
0530: 004F 69 01          ADCIM  $01   ADD DECIMAL 1.
0540: 0051 85 0C          STA     SECNDS
0550: 0053 C9 60          CMPIM  $60   IF < 60 THEN FINISHED
0560: 0055 30 22          BMI    RESET
0570: 0057 A9 00          LDAIM  $00   ZERO SECONDS
0580: 0059 85 0C          STA     SECNDS
0590:
0600:      INCREMENT MINUTES
0610:
0620: 005B A5 0B          LDA     MINUTS GET MINUTES BYTE
0630: 005D 69 00          ADCIM  $00   ADD IN CARRY FROM PREVIOUS COMPARE
0640: 005F 85 0B          STA     MINUTS
0650: 0061 EA          NOP     FOR TIMING

```

Listing 1 continued

```

0660: 0062 C9 60      CMPIM $60   IF < 60 , FINISHED
0670: 0064 30 13      BMI  RESET
0680: 0066 A9 00      LDAIM $00  ZERO MINUTES
0690: 0068 85 0B      STA  MINUTS
0700:
0710:                INCREMENT HOURS
0720:
0730: 006A A5 0A      LDA  HOURS
0740: 006C 18          CLC          THIS TIME CLEAR CARRY (FOR TIMING)
0750: 006D 69 01      ADCIM $01
0760: 006F 85 0A      STA  HOURS
0770: 0071 C9 25      CMPIM $25  WOULD BE 13 FOR 12 HOUR CLOCK
0780: 0073 30 04      BMI  RESET
0790: 0075 A9 01      LDAIM $01
0800: 0077 85 0A      STA  HOURS
0810:
0820:                RESET TIMER AND NUMDLY
0830:
0840: 0079 A9 00      RESET LDAIM $00
0850: 007B 85 0D      STA  NUMDLY
0860: 007D 4C 2B 00    JMP  MAXDLY
0870:
0880:                RESTORE REGISTERS
0890:
0900: 0080 68          RESTOR PLA
0910: 0081 A8          TAY
0920: 0082 68          PLA
0930: 0083 AA          TAX
0940: 0084 68          PLA
0950: 0085 40          RTI
0960:

THIS PROGRAM DISPLAYS THE HOURS, MINUTES, AND SECONDS

0070: 0200          ORG  $0200
0080:
0090: 0200          NUMDLY *  $000D
0100: 0200          CONVD *  $1F48
0110: 0200          TIME *  $000A
0120:
0130: 0200 A9 01      LDAIM $01  INITIALIZE INTERRUPT COUNTER
0140: 0202 85 0D      STA  NUMDLY
0150: 0204 A9 FF      LDAIM $FF  INITIALIZE DIVIDE BY 1024 COUNTER
0160: 0206 8D 0F 17  STA  $170F
0170: 0209 58          CLI          ENABLE INTERRUPTS
0180: 020A A9 7F      LDAIM $7F  INITIALIZE DISPLAY PORT
0190: 020C 8D 41 17  STA  $1741
0200: 020F A2 09      START LDXIM $09  X REG POINTS TO DIGIT TO BE DISPLAYED
0210: 0211 A0 00      LDYIM $00  Y REG IS INDEX TO TIME BYTE TO BE DISPLAYED
0220:
0230:                THIS IS THE START OF THE LOOP
0240:                THE PRECEDING CODE IS INITIALIZATION
0250:
0260: 0213 C0 04      LOOP  CPYIM $04  IF Y REG IS >= 4 THEN JUMP BACK TO START
0270: 0215 10 F8      BPL  START
0280:
0290: 0217 B9 0A 00    LDAY  TIME  GET BYTE OF TIME POINTED TO BY Y REG
0300: 021A 4A          LSRA      GET HIGH ORDER 4 BITS
0310: 021B 4A          LSRA
0320: 021C 4A          LSRA
0330: 021D 4A          LSRA
0340: 021E 20 48 1F  JSR  CONVD  OUTPUT 4 BITS TO POSITIONPOINTED
0350:                TO BY X REG
0360: 0221 B9 0A 00    LDAY  TIME
0370: 0224 29 0F      ANDIM $0F  GET LOW ORDER 4 BITS
0380: 0226 20 48 1F  JSR  CONVD  OUTPUT
0390: 0229 A9 00      LDAIM $00  TURN OFF DISPLAY
0400: 022B 8D 40 17  STA  $1740
0410: 022E C8          INY          INCREMENT Y REG
0420:                X REG IS INCREMENTED BY CONVD
0430: 022F 10 E2      BPL  LOOP  BRANCH ALWAYS TO LOOP

```

# PROGRESSIVE SOFTWARE

Presents

Software and Hardware for your APPLE

**SALES FORECAST** provides the best forecast using the four most popular forecasting techniques: linear regression, log trend, power curve trend, and exponential smoothing. Neil D. Lipson's program uses artificial intelligence to determine the best fit and displays all results for manual intervention. **\$9.95**

**CURVE FIT** accepts any number of data points, distributed in any fashion, and fits a curve to the set of points using log curve fit, exponential curve fit, least squares, or a power curve fit. It will compute the best fit or employ a specific type of fit, and display a graph of the result. By Dave Garson. **\$9.95**

**UTILITY PACK 1** combines four versatile programs by Vince Corsetti, for any memory configuration.

- **Integer to Applesoft conversion:** Encounter only those syntax errors unique to Applesoft after using this program to convert any Integer BASIC source.
- **Disk Append:** Merge any two Integer BASIC sources into a single program on disk.
- **Integer BASIC copy:** Replicate an Integer BASIC program from one disk to another, as often as required, with a single keystroke.
- **Applesoft Update:** Modify Applesoft on the disk to eliminate the heading always produced when it is first run.
- **Binary Copy:** Automatically determines the length and starting address of a program while copying its binary file from one disk to another in response to a single keystroke. **\$9.95**

**MISSILE-ANTI-MISSILE** display a target, missile, anti-missile, a submarine and map of the U.S. on the screen. A hostile submarine appears and launches a pre-emptive nuclear attack controlled by paddle 1. As soon as the hostile missile is fired, the U.S. launches its anti-missile controlled by paddle 0. Dave Moteles' program offers high resolution and many levels of play. **\$9.95**

**TOUCH TYPING TUTOR** teaches typing. Indicates speed and errors made. Finger Bldrs, Gen. Typing, Basic Language and User Supplied. Diskette. Written by Wm. A. Massena. **\$19.95**

**APPLE MENU COOKBOOK** index-accessed data storage/retrieval program. Recipes stored, unlimited lines per entry. Easy editing. Formulated after N.Y. Times Cookbook. Other useful features included. **\$19.95**  
Written by Wm. Merlino, M.D.

**MAILING LIST PROGRAM** maintains complete record of name, address, phone no., mailing labels accommodates parallel card or built-in printer driver, easy data entry. Diskette. 32K. **\$19.95**

## POSTAGE AND HANDLING

Please add \$1.25 for the first item and \$.75 for each additional item.

- Programs accepted for publication
- Highest royalty paid

U.S. and foreign dealer and distributor inquiries invited

All programs require 16K memory unless specified

**BLOCKADE** lets two players compete by building walls to obstruct each other. An exciting game written in Integer BASIC by Vince Corsetti. **\$9.95**

**TABLE GENERATOR** forms shape tables with ease from directional vectors and adds additional information such as starting address, length and position of each shape. Murray Summers' Applesoft program will save the shape table anywhere in usable memory. **\$9.95**

**OTHELLO** may be played by one or two players and is similar to chess in strategy. Once a piece has been played, its color may be reversed many times, and there are also sudden reverses of luck. You can win with a single move. Vince Corsetti's program does all the work of keeping board details and flipping pieces. **\$9.95**

**SINGLE DRIVE COPY** is a special utility program, written by Vince Corsetti in Integer BASIC, that will copy a diskette using only one drive. It is supplied on tape and should be loaded onto a diskette. It automatically adjusts for APPLE memory size and should be used with DOS 3.2. **\$19.95**

## SAUCER INVASION SPACE MAZE STARWARS

ROCKET PILOT Written by Bob Bishop

Each **\$9.95**

**SAUCER INVASION** lets you defend the empire by shooting down a flying saucer. You control your position with the paddle while firing your missile at the invader. Written by Bob Bishop. **\$9.95**

## HARDWARE

**LIGHT PEN** with seven supporting routines. The light meter takes intensity readings every fraction of a second from 0 to 588. The light graph generates a display of light intensity on the screen. The light pen connects points that have been drawn on the screen, in low or high resolution, and displays their coordinates. A special utility displays any number of points on the screen, for use in menu selection or games, and selects a point when the light pen touches it. The package includes a light pen calculator and light pen TIC TAC TOE. Neil D. Lipson's programs use artificial intelligence and are not confused by outside light. The hi-res light pen, only, requires 48K and ROM card. **\$34.95**

## TO ORDER

Send check or money order to:

P.O. Box 273  
Plymouth Meeting, PA 19462

PA residents add 6% sales tax.



# MICRO Dealers

*This list is published as a service to our readers, and to the dealers that carry MICRO and other 6502 products. The dealers are in zip code order so that you can find the ones in your area quickly. Not all dealers are here; just the ones who sent us the information forms. We will run another list like this in a few months.*

The Microcomputer Store  
1568 Avenida Central  
Caparra Heights, PR 00920  
(809) 781-0350  
Contact: A. Richner, J. Martinez  
6502: PET Computers, peripherals

The Computer Store  
Route 9 Deerskin Plaza  
Framingham, MA 01701  
(617) 879-3720  
Contact: L. Virklir  
6502: APPLE, Micro Nova, books, software

The Computer Store  
63 South Main Street  
Windsor Locks, CT 06029  
(203) 627-0188  
Contact: R. Cirno  
6502: KIM-1, APPLE, Mt. Hardware, Heuristics, Calif. Compu. Systems, software

The Computer Lab, Inc.  
130 Jefferson Avenue  
New London, CT 06320  
(203) 447-1079

Connecticut Microcomputer Inc.  
150 Pocano Road  
Brookfield, CT 06804  
Contact: S. Fletcher

Computerworks  
1439 Post Road East  
Westport, CT 06880  
(203) 255-9096  
Contact: S. Merrin  
6502: APPLE, PET, Software, peripherals.

Computer Nook  
Route 46, Pine Brook Plaza  
Pine Brook, NJ 07058  
(201) 575-9468  
Contact: B. Stroeber  
6502: APPLE computers and peripherals, Commodore computers, disk drives and printers.

HDE, Inc.  
P.O. Box 120  
Allamuchy, NJ 07820  
(201) 362-6574  
Contact: R. Grabowsky  
6502: 8K Static RAM, 15 Slot card cage, prototyping cards, 8" disk systems, 5 1/4" disk systems for KIM, AIM, SYM.

Computerland of Cherry Hill  
1442 East Route 70  
Cherry Hill, NJ 08034  
(609) 795-5900  
Contact: D. Phelps  
6502: APPLE, PET, ATARI, (serve for all).

Custom Computer Specialists, Inc.  
208 Roanoke Avenue  
Riverhead, NY 11901  
(516) 369-2199

Computer Workshope  
3848 Wm Penn Highway  
Monroeville, PA 15146  
(412) 823-6722  
Contact: D. Eckert  
6502: BASIC classes, APPLE II computers, APPLE software, service center.

Erie Computer  
2127 West 8th Street  
Erie, PA 16505  
(814) 454-7652  
6502: APPLE, OSI, software, service.

Computerland, New Castle  
Astro Shopping Center  
Kirkwood Highway  
Newark, DE 19711  
(302) 738-9656  
Contact: B. Stewart, C. Grady  
6502: APPLE, PET, KIM, SYM. Hardware, software, design and repair for most systems.

Computers, Etc.  
13A Allegheny Avenue  
Towson, MD 21204  
(301) 296-0520

Computer Crossroads, Inc.  
9143G Red Branch Road  
Columbia, MD 21045  
(301) 730-5513  
Contact: R. Simpson  
6502: Full line APPLE dealer.

Computers Unlimited, Inc  
907 York Road  
Towson, MD 21204  
(301) 321-1553

Computerland/Tyson's Corner  
8411 Old Courthouse Road  
Vienna, VA 22180  
(703) 893-0424  
6502: APPLE, ATARI, Commodore, authorized factory service.

Computers Plus, Inc.  
6120 Franconia Road  
Alexandria, VA 22310  
(703) 971-1996  
Contact: J. Wells  
6502: APPLE systems, software, books, maintenance

Home Computer Center  
2927 Virginia Beach Blvd.  
Virginia Beach, VA 23452  
(804) 340-1977

6502: APPLE computers, peripherals, parts, service, distributes own football program.

Byte Shop, Greensboro  
218 North Elm Street  
Greensboro, NC 27401  
(919) 275-2983  
Contact: B. Terrell  
6502: KIM, PET, APPLE, sales, services, peripherals, books, magazines, software.

Datamart of South Carolina  
1901 Laurens Road  
Greenville, SC 29607  
(803) 233-5753  
Contact: B. Thompson  
6502: APPLE II

H.I.S. Computermaion, Inc.  
1295 Cypress Avenue  
Melbourne, FL 32935  
Contact: J. Flores, R. Wilson  
6502: KIM, APPLE.

Computer Age, Inc.  
1308 North Federal Highway  
Pompano Beach, FL 33062  
(305) 942-1814  
Contact: L. Fitzpatrick

The Computer Store  
21 Clearwater Mall  
Clearwater, FL 33516  
(813) 796-1195  
6502: APPLE II, level 1 service center, authorized business dealer.

AMF Electronics  
11146 North 30th Street  
Tampa, FL 33612  
(813) 971-4072  
Contact: A. Andre  
6502: APPLE dealer, authorized service center, centronics dealer.

Computerland  
3020 University Drive  
Huntsville, AL 35805  
(205) 539-1200

Computerlab  
627 South Mendenhall  
Memphis, TN 38117  
(901) 761-4743  
Contact: Rick or Jim  
6502: AIM, KIM, APPLE II enclosure group

Micro Mini Computer World, Inc.  
74 Robinwood Avenue  
Columbus, OH 43213  
(614) 235-5813, -6058  
Contact: Mike, Will, Tom

6502: KIM, SYM, Commodore, peripherals, software, full service, Memory plus.

ComputerLand of Cleveland  
East: 1288 SOM Center Road  
Mayfield Heights, OH 44124  
(216) 461-1200  
West: 4579 Great N. Blvd.  
North Olmsted, OH 44070  
(216) 777-1433  
Contact: any employee  
6502: full hardware, software, APPLE, ATARI, Synertek.

The Basic Computer Shop  
Fairlawn Plaza  
2671 West Market Street  
Akron, OH 44313  
(216) 867-0808  
Contact: P. Reich

Micro Computer Center  
7900 Paragon Road  
Dayton, OH 45459  
(513) 435-9355  
6502: APPLE II, sales and service.

Computerland—Merrillville  
19 West 80th Place  
Merrillville, IN 46410  
(219) 769-8020  
6502: KIM, SYM, APPLE, PET, MICRO magazine, books.  
Computer Center of South Bend  
51591 US 31N  
South Bend, IN 46637  
Contact: B. Milliken  
6502: Commodore, OSI, APPLE, hardware, software.

Computerland of Grand Rapids  
2927 28th Street, SE  
Kentwood, MI 49508  
(616) 942-2931  
6502: APPLE, Commodore, ATARI, SYM.

Computerland o: Madison  
690 South Whitney Way  
Madison, WI 53711  
(608) 273-2020  
Contact: J. Sullivan  
6502: PET, APPLE.

Zim Computers, Inc.  
5717 Xerxes Avenue North  
Brooklyn Center, MN 55429  
(612) 560-0336  
6502: APPLE, Commodore

Computerland of Oak Lawn  
10935 South Cicero  
Oak Lawn, IL 60453  
(312) 422-8080  
6502: APPLES, Level 1 service

Computer Shoppe  
3828 Veterans Blvd.  
Metairie, LA 70002  
(504) 454-6600  
Contact: D. Hughes  
6502: APPLE, PET, ATARI, software,  
books and accessories

Computer Shoppe  
12-A Westbank Expressway  
Gretna, LA 70053  
(504) 366-0687

High Technology of Tulsa  
2601-D So. Memorial  
Tulsa, OK 74129  
(918) 664-9754  
Contact: D. Deardorff  
6502: APPLE computer and related  
products

Comtel, Inc.  
Computers Plus  
5970 Broadway Blvd.  
Garland, Texas 75043  
(214) 840-1383  
Contact: B. Jordan

Farnsworth Computer Center  
1891 N. Farnsworth Avenue  
Aurora, IL 60505  
(312) 851-3888  
Contact: L. Snyder  
6502: APPLE

Computerland  
136 Ogden Avenue  
Downes Grove, IL 60515

The Computer Store of Rockford  
2320 North Central Ave.  
Rockford, IL 61103  
(815) 962-7580  
Contact: C. Person  
6502: APPLE, OSI

Byte Shop  
1602 South Neil  
Champaign, IL 61820  
(217) 352-2323  
Contact: J. Harter  
6502: APPLE, PET, ATARI, software,  
full repair service, custom program-  
ming.

Computer Station  
12 Crossroads Plaza  
Granite City, IL 62040  
(618) 452-1860  
Contact: G. Baltzel  
6502: APPLE computers and software

Illinois Computer Mart, Inc.  
1114 W. Main Street  
Carbondale, IL 62901  
(618) 529-BYTE  
Contact: E. C. Martin

Forsythe Computers, Inc.  
7748 Forsyth Blvd.  
Clayton, MO 63106  
(314) 721-4300  
6502: Authorized APPLE dealer and  
service center. Books, magazines, pro-  
gramming and programming referrals.  
OSI C3-OEM

Futureworld, Inc.  
12304 Manchester  
St. Louis, MO 63131

Personal Computer Center  
3819 West 95th  
Overland Park, Kansas 66206  
(913) 649-5942

Computerland  
10049 Santa Fe Drive  
Overland Park, Kansas 66212  
(913) 492-8882  
6502: APPLE, PET, ATARI, KIM; also  
APPLE and PET service.

Computerland—Independence  
1214 So. Noland Road  
Independence, MO  
(816)461-6502

Micro Store  
634 S. Central  
Richardson, TX 75080

Computerland  
17647 El Camino Real  
Houston, TX 77058  
(713) 488-8153  
Contact: K. Arnold  
6502: APPLE, PET, SYM, ATARI, hard-  
ware, software, service

Computer City  
12704 North Freeway  
Houston, TX 77060  
(713) 821-2702  
Contact: R. Bluefarb  
6502: APPLE II, full line of software,  
repair.

Computercraft  
3211 Fondren  
Houston, TX 77063  
(713) 977-0664  
Contact: D. Airhart  
6502: APPLE II, hardware, software,  
books, magazines, authorized service  
center, level 1.

Computer Solutions  
5135 Fredericksburg Road  
San Antonio, TX 78229  
(512) 341-8851  
6502: APPLE, software.

Computerland—austin  
3300 Anderson Lane  
Austin, TX 78757  
(512) 452-5701  
Contact: C. Phillips  
APPLE, authorized dealer and service  
center

Computerland—Denver  
2422 S. Colorado Blvd.  
Denver, CO 80222  
(303) 759-4685  
Contact: S. Cohan

Personal Computer Place  
1840 West Southern  
Mesa, AZ 85202  
(602) 833-8949  
Contact: R. Smith  
6502: PET, software, ROM updates,  
schematics, parts, etc.

Home Computers  
1775 East Tropicana, 2  
Las Vegas, NV 89109  
(702) 736-6363  
Contact: I. Jordan  
6502: APPLE, PET, computers and  
peripherals.

Computerland—South Bay  
16720 Hawthorne Blvd.  
Lawndale, CA 90260  
(213) 371-4624  
Contact: Pete  
6502: APPLE

Rainbow Computing, Inc.  
9719 Reseda Blvd.  
Northridge, CA 91324  
(213) 349-5560  
Contact: J. Anderson  
6502: APPLE, ATARI

Computer Components  
3808 West Verdugo Avenue  
Burbank, CA 91505  
(213) 848-5521  
Contact: Linda or Joan  
6502: APPLE, ATARI, level 1 service,  
extensive software.

Southwestern Data Systems  
P.O. Box 582  
Santee, CA 92071  
(714) 562-3670  
Contact: R. Wagner  
6502: APPLE II software, APPLE-DOC,  
Roger's Easel, Programmers' Utility  
Pack, Shoppe Master, L1st Master, The  
Correspondent.

Computer Age, Inc.  
4688 Convoy Street, Suite 105  
San Diego, CA 92111  
(714) 565-4042  
Contact: J. Cheng  
6502: APPLE II, PET, ATARI 800,  
authorized service center for APPLE &  
PET.

The Byte Shop  
14300 Beach Blvd.  
Westminster, CA 92683  
(714) 892-0500  
Contact: J. Hunter  
6502: APPLE II, complete line of  
peripherals.

Computer World  
6791 Westminster Avenue  
Westminster, CA 92683  
(714) 891-2584  
Contact: D. Smith  
6502: APPLE, ATARI, KIM, AIM, PET,  
software, servicing, books, magazines,  
custom software peripherals, disks,  
joysticks, light pens, printers.

Jay-Kern Electronics  
1135 Columbus Avenue  
Bakersfield, CA 93305  
(805) 871-5800  
6502: Commodore

Computers Made Easy  
819 East Avenue, Q9  
Palmdale, CA 93550  
(805) 947-8613  
6502: APPLE, KIM, ATARI, PET, all ac-  
cessories, services.

Computer Place, Inc.  
P.O. Box 22530  
28384 Carmel Rancho Lane  
Carmel, CA 93923  
(408) 624-7111

A.I.D.S.  
301 Balboa Street  
San Francisco, CA 94118  
(415) 221-8500  
Contact: M. Wong  
6502: APPLE, authorized service  
center.

Computerland  
22634 Foothill Blvd.  
Hayward, CA 94541  
(415) 538-8080  
6502: full service, full line

Skyles Electric Works  
10301 Stonydale Drive  
Cupertino, CA 95014  
(800) 538-3083  
Contact: B. Skyles  
6502: keyboards, memories, printers,  
toolkit, software development sys, all  
PET models.

Computerland  
12020 SW Main Street  
Tigard, OR 97223  
(503) 620-6170  
6502: APPLE, PET

Computerland, South King Co.  
1500 5336th Street, Suite 12  
Federal Way, WA 98003  
(206) 927-8585  
Contact: S. Lougee  
6502: APPLE, PET, full line, authorized  
APPLE service center.

Scientific Business Instruments  
The Diamond Center Mall  
800 East Diamond, Suite 140  
Anchorage, AK 99502  
(907) 344-8352  
6502: APPLE, OSI.

#### FOREIGN

TJB Microsystems Ltd.  
10991 124th Street  
Edmonton, Alberta  
Canada T5M 0H9  
(403) 452-9476  
Contact: J. Nickerson  
6502: APPLE, PET.

Vulcan Computers  
20571 Fraser Highway  
Langley, British Columbia  
Canada V3A 4G4  
(604) 530-8572  
Contact: G. Tremain  
6502: PET, APPLE, Beta, books, soft-  
ware, service.

The Computer Circuit, Ltd.  
737 Richmond Street  
London, Ontario  
Canada N6A 3H2  
(519) 672-9370  
Contact: W. Solotow  
6502: PET, APPLE, KIM, sales, soft-  
ware, service.

The Computer Centre Pte. Ltd.  
5345 Woh Hup Complex  
Beach Road  
Singapore 0719

### Would you like to Become a MICRO Dealer?

MICRO is a quality  
6502 magazine. Our  
current dealers report  
that having MICRO  
available for sales in  
their stores actually  
helps sell 6502 based  
systems.

We require a mini-  
mum quantity of only  
10 copies per month,  
and we offer a stan-  
dard trade discount.

Other items are the  
Best of MICRO,  
volumes 1 and 2, and  
All of MICRO.

If you are interested  
in becoming a MICRO  
dealer, please write  
to:

MICRO  
P.O. Box 6502  
Chelmsford, MA  
01824

# A Home Message Center

---

If your house is like mine, there is never a pencil around when you need it, and when a message is left taped to the refrig, nobody ever notices. Put your messages on the APPLE and they will not be missed! This "Message Center" can be a starting point for other automatic display systems.

---

William McLean  
1642 Edgewater Lane  
Camarillo, CA 93010

This program was born from a dual need: I wanted to find a daytime use for my new computer, and I wanted to get my family involved in some small way with the APPLE so that they would lose that feeling of awe and "separation" that I see among the families of many computerists.

As I've had my APPLE for less than two months, the program would have to be fairly simple, but I really wanted to incorporate something creative. A tall order for a neophyte programmer who only learned the command LOAD two months ago, but I'm happy with the results and I hope that others will find some value in the ideas incorporated.

A few comments and explanations:

1. If you should happen to get an error message or hit control C, just type in GOTO 0 before listing so you'll have a full page to list without hitting reset.

2. Now you can type in GOTO 90 and the program should recommence without losing your message.

3. Temporary register K\$ retains the last message even though it has been erased from the registers C\$ through H\$. So you can get it repeated by requesting it again even though the name no longer shows on the video screen.

4. This program has been set up to hold from 1 to 6 messages in a total of about 10K of RAM but can be modified to hold almost as many more as you like if you have adequate memory. You will need to modify number 90 to allow an extra line or two to display names (POKE 35,4 or 35,5); number 100 to move the display down an equal amount (POKE 34,4 or 34,5); line number 145 to check the extra registers for status; lines 150 through 160 to add more z "name strings"; 170 through 180 to add more "message strings"; and lines 190 through 200 to erase the strings, once used.

The *Marquis* type of scrolling

message is also useful for announcements for club meetings, or attention-getting continuous replay displays at shows or store windows. You can limit the number of times the message is displayed by deleting line 460 and assigning R in a 300 a value equal to the number of repeats that you want.

At home, we leave the video screen turned off and the APPLE II on. Each member of the family, upon seeing the computer "on" light, checks for messages by turning on the video momentarily and checking the names at the top of the screen.

One last hint: if you leave more than one message for the same person, you must change the "name" slightly. (I suggest a simple addition of a number, as in "John", "John2", "John3", etc.) If you should inadvertently enter two messages for the same name, you will erase them both after only seeing one of them.

*Copies of this program on cassette tapes are available from the author.*

```

IPR#6
IPR#6

LIST, PR#1
0 POKE 32,0: POKE 33,40: POKE 34
  ,0: POKE 35,24
20 DIM A$(255),B$(255),C$(255),D$(
  25),E$(25),F$(25),G$(25),H$(
  25)
21 DIM K$(255),CC$(255),DD$(255)
  ,EE$(255),FF$(255),GG$(255),
  HH$(255)
40 A = 0:C = 1
90 POKE 32,0: POKE 33,40: POKE 3
  4,0: POKE 35,3: HOME
95 INVERSE : PRINT "MESSAGES WAIT
  ING FOR: ";: NORMAL : PRINT
  C$;D$;E$;F$;G$;H$
100 POKE 32,0: POKE 33,40: POKE
  34,3: POKE 35,24: HOME
120 HOME : PRINT "
  =====
  HOME MESSAGE CENTER
  =====
  "
121 PRINT : PRINT : PRINT
130 PRINT "WHICH DO YOU WANT ---
  1. ENTE
  R A NEW MESSAGE
  2. RECEIVE A MESSAGE
  ": INPUT "WHI
  CH? ";X
131 IF X = 2 GOTO 185
140 INPUT "MESSAGE IS FOR (NAME)
  ";B$
141 IF LEN (B$) > 1 THEN B$ = B
  $ + " - "
145 FLASH : IF LEN (H$) > 1 AND
  LEN (G$) > 1 AND LEN (F$) >
  1 AND LEN (E$) > 1 AND LEN
  (D$) > 1 AND LEN (C$) > 1 THEN
  PRINT "SORRY, BUT ALL MY ME
SSAGE REGISTERS ARE FULL!!":
FOR Y = 1 TO 500: NEXT Y: GOTO
90
146 NORMAL
150 IF LEN (H$) < 1 AND LEN (G
  $) > 1 AND LEN (F$) > 1 AND
  LEN (E$) > 1 AND LEN (D$) >
  1 AND LEN (C$) > 1 THEN H$ =
  B$
152 IF LEN (G$) < 1 AND LEN (F
  $) > 1 AND LEN (E$) > 1 AND
  LEN (D$) > 1 AND LEN (C$) >
  1 THEN G$ = B$
154 IF LEN (F$) < 1 AND LEN (E
  $) > 1 AND LEN (D$) > 1 AND
  LEN (C$) > 1 THEN F$ = B$
156 IF LEN (E$) < 1 AND LEN (D
  $) > 1 AND LEN (C$) > 1 THEN
  E$ = B$
158 IF LEN (D$) < 1 AND LEN (C
  $) > 1 THEN D$ = B$
160 IF LEN (C$) < 1 THEN C$ = B
  $
165 INPUT "THE MESSAGE IS?? (5 L
  INES OR LESS, IN QUOTATION
  MARKS, PLEASE)
  ";A$
170 IF LEN (HH$) < 1 AND LEN (
  GG$) > 1 AND LEN (FF$) > 1 AND
  LEN (EE$) > 1 AND LEN (DD$
  ) > 1 AND LEN (CC$) > 1 THEN
  HH$ = A$
172 IF LEN (GG$) < 1 AND LEN (
  FF$) > 1 AND LEN (EE$) > 1 AND
  LEN (DD$) > 1 AND LEN (CC$
  ) > 1 THEN GG$ = A$
174 IF LEN (FF$) < 1 AND LEN (
  EE$) > 1 AND LEN (DD$) > 1 AND
  LEN (CC$) > 1 THEN FF$ = A$
176 IF LEN (EE$) < 1 AND LEN (
  DD$) > 1 AND LEN (CC$) > 1 THEN

```



```

300 FOR R = 1 TO 2: FOR M = 1 TO
  ( LEN (K$) + 40):A = M: IF A
  > 38 THEN A = 38
320 C = 1: IF M > 38 THEN C = M -
  37
340 REM C=BEGINNING CHARACTER
  AND A=NUMBER OF EXTRA CHARAC
  TERS TO BE PRINTED.
360 HOME : HTAB 40 - A
380 PRINT MID$ (K$,C,A): FOR X =
  1 TO 120: NEXT X
400 IF PEEK ( - 16384) > 127 THEN
  GOTO 90
420 POKE - 16368,0
440 NEXT M: NEXT R
460 GOTO 300
10000 REM "HOME MESSAGE CENTER"
  WAS PROGRAMMED BY BILL MCL
  EAN, 1642 EDGEWATER LANE, CA
  MARILLO, CALIF. 93010
10001 REM ANYONE IS FREE TO USE
  AND COPY IT. MY PHONE IS 8
  05-482-2048. PLEASE CALL OR
  WRITE IF YOU COME UP WITH M
  EANINGFUL CHANGES.
  ?SYNTAX ERROR

```

```

EE$ = A$
178 IF LEN (DD$) < 1 AND LEN (
  CC$) > 1 THEN DD$ = A$
180 IF LEN (CC$) < 1 THEN CC$ =
  A$
182 GOTO 90
185 INPUT "WHICH MESSAGE WOULD Y
  OU LIKE TO HAVE DISPLAYED
  ? (TYPE IN THE NAME EXACTLY
  ) " : J$: J$ = J$ + " - "
190 IF C$ = J$ THEN K$ = C$ + CC
  $: IF C$ = J$ THEN CC$ = "":
  IF C$ = J$ THEN C$ = " "
192 IF D$ = J$ THEN K$ = D$ + DD
  $: IF D$ = J$ THEN DD$ = "":
  IF D$ = J$ THEN D$ = " "
194 IF E$ = J$ THEN K$ = E$ + EE
  $: IF E$ = J$ THEN EE$ = "":
  IF E$ = J$ THEN E$ = " "
196 IF F$ = J$ THEN K$ = F$ + FF
  $: IF F$ = J$ THEN FF$ = "":
  IF F$ = J$ THEN F$ = " "
198 IF G$ = J$ THEN K$ = G$ + GG
  $: IF G$ = J$ THEN GG$ = "":
  IF G$ = J$ THEN G$ = " "
200 IF H$ = J$ THEN K$ = H$ + HH
  $: IF H$ = J$ THEN HH$ = "":
  IF H$ = J$ THEN H$ = " "
220 HOME : PRINT " =====
  =====
  HOME MESSAGE CENTER
  =====
  " : FOR X = 1 TO 9: PRINT
  : NEXT X
240 PRINT "TO ERASE CURRENT MESS
  AGE AND/OR TO ENTER NEW
  MESSAGES, PUSH SPACE BAR"
260 FOR W = 1704 TO 1743: POKE W
  ,158: POKE W - 512,159: NEXT
  W
280 POKE 32,0: POKE 33,40: POKE
  34,11: POKE 35,13

```

#### CLUB FORUM Update

##### Dental Computer Newsletter

Offers: monthly newsletter, software exchange, advice, experience and access to members in your area. Membership: \$12 per year  
 Dental Computer Newsletter  
 E.J. Neiburger, Editor  
 1000 North Avenue  
 Waukegan, IL 60085



# Skyles Electric Works

Presenting the Skyles MacroTeA

## The Software Development System For the Professional Programmer and The Serious Amateur Software Hobbyist

...and for anyone who needs to automate dedicated industrial measurement and control applications.

The Macro TeA, designed for use with the Commodore PET to create a remarkable synergism: a complete, integrated software development system for the 6502...the only 6502 system not requiring a separate disk drive. With over 60 commands for your complete machine language programming.

...a lightning fast...fast...fast.....  
....machine language assembler with true macro capabilities. Assemble 16K source text in less than ten seconds! A single name identifies a whole body of lines. Macro and conditional assembly support. Automatic line numbering. Labels up to ten characters long; 10<sup>16</sup> different labels.

```

ASSEMBLE LIST
                                0100 MOVE TBL 1 TO TBL2
                                0110          BA $400
0400 - A0 0B 0120 LOOP          LDY #00
0402 - B9 0B 04 0130          LDA TBL1.Y
0405 - 89 0B 05 0140          STA TBL2.Y
0408 - C8          0150          INY
0409 - D0 F7 0160          BNE LOOP
                                0170
040B          0180 TBL1          DS 256
050B          0190 TBL2          DS 256
                                0200
                                0210          EN

LABEL FILE 1 = EXTERNAL

START = 0400      LOOP = 0402      TBL1 = 040B
TBL2 = 050B
110000.050B.050B

```

Install permanently without tools and in less time than it takes to load an equivalent sized assembler/text editor program from tape. No tape loading ever. And no occupying of RAM memory space: the MacroTeA puts 10K of executable machine language code in ROM(9800 to BFFF) and 2K in RAM (9000 to 97FF).

...a super powerful text editor. 26 commands with string search and replace capability. Manuscript feature. Test loading and storage on tape or disks. Supports tape drives, disks, CRT, printers and keyboard.

...an enhanced monitor with 11 powerful commands for program debugging and final polishing.

...with a warm-start button, on a 12 inch cable. Reset the PET but not the 1792 bytes of object code in the Macro TeA RAM memory.

...a completely solid state firmware system ...all in ROM and RAM. No tapes to load. The system is available from the time you turn on your PET to the time you shut it off.

15 chips on a single high quality printed circuit board; interfaces with PET's parallel address and data bus or with Skyles Memory Adapter. A comprehensive 170 page manual is included

Truly, there is simply no other system of this magnitude at anywhere near this price. **\$395.00 \***

(With any Skyles Memory Expansion System, \$375.00)

*\*California residents: please add 6% or 6.5% sales tax as required*

VISA, MASTERCHARGE ORDERS CALL (800) 538-3083 (except California residents)  
CALIFORNIA ORDERS PLEASE CALL (408) 257-9140



# Skyles Electric Works

231 E. South Whisman Road  
Mountain View, CA 94041  
(408) 735-7891

# Stop That PET!

---

**That fantastic new program you are developing for the PET keeps bombing, causing the keyboard to lockup, and forcing you to RESET - thereby losing information about your program and its problems. Is there a way to STOP the run-away program? Would I ask the question if the answer wasn't "Yes"?**

---

Gary J. Bullard  
4808 S. Elwood 675  
Tulsa, OK 74107

Commodore, for some reason, decided that the PET did not need a reset button. Since they did not provide a ROM monitor, perhaps they figured a reset button was unnecessary. This decision may have affected their sales somewhat.

They did provide a "STOP" button which serves as the equivalent of a CONTROL C, but this was useless if your cursor disappeared (a common early PET problem) or your new machine-language program decided to loop forever instead of returning control to BASIC.

Machine-language programming for the PET therefore became an exercise in frustration:

1. Write your machine-language program.
2. Enter your program into the PET.
3. SAVE it. (Important!)
4. Execute your program via SYS or USR functions.
5. Stare impotently at dead PET. Frantically press STOP key as if you really think it will help.
6. Curse! Be creative!
7. Apply Commodore's RESET procedure. (i.e., turn PET off and back on)
8. Go back to step 2.

Somewhere between steps 2 and 3 you should perhaps examine your program for errors of coding or keypunching that could cause the PET to lock up. The difficulty with this procedure (for me anyway) is that if I thought the coding was wrong, I wouldn't have written it that way in the first place. So I'm left to examine five or six pages of coding that look perfectly good to me. What is needed is a way of knowing exactly where the program hung up so as to narrow the search.

If only there was a way to force an interrupt on the PET, then I could recover control and try again. At least it would eliminate steps 5, 6, 7, and 8. I could then insert breakpoints and narrow the problem down to a manageable level.

Commodore was ahead of me again. The non-maskable interrupt is permanently tied down so it vectors to the cold-start routines at power-on time. And since the cold-start routines destroy the contents of RAM, using this line as a reset would have the same effect as turning the PET off and on. I would have to make hardware changes and burn new PROMS to gain a reset capability with the non-maskable interrupt. Commodore wins this round.

But wait! Can Commodore be beaten at their own game? Maybe. . . .

There is one feature of the PET for which Commodore truly deserves a pat on the head. The PET has a built in real-time clock. This clock is updated by soft-

ware once every sixtieth of a second. A circuit within the PET monitoring the AC line provides sixty interrupts a second. So the PET is not really "dead" at step 5 above. It is merrily executing your infinite loop and keeping good time, but it refuses to answer the keyboard; it is just playing dead.

Let's follow this idea a little way. Every sixtieth of a second, an interrupt is generated that causes the PET to jump indirectly through an address at \$FFFE. This routine saves the accumulator, X register, and Y register on the stack and then jumps indirectly through \$0219 to the clock routine. This vector is changed, when necessary, by the operating system to keep the clock routines from goofing up the timing for tape reads and writes. Normally, however, this vector remains constant. The exceptions to this rule will become important later.

Get the idea? Let's change that vector so the PET is forced to execute a short routine that checks the keyboard sixty times a second. Then, if the "STOP" key is pressed, we can provide a means of returning control to the operator. If the "STOP" key is not pressed, then the routine can proceed to its normal destination.

Now, since we've gone to this much trouble, why not see if we can derive some useful information from this exercise? It will be necessary to clean the stack so the BASIC warm-start address can replace the "real" interrupted return

address. Why not save this information so we can discover just where the interrupt occurred?

Those of you who have had the tenacity to read this far, but who are not the least interested in a description of a machine-language program may wish to skip this section. How to use the program will be told in the last section.

Listing 1 is the "assembly" listing of my program. A few words would now be appropriate to describe my peculiar "assembler". This assembler is a one-line assembler, approximately equivalent to the assembler provided in the Apple II. However, it is written in BASIC, and it has a few features I find convenient. For instance, I think in decimal, so I like to know the decimal address of an instruction. This is handy, considering that the functions SYS, PEEK, and POKE all use decimal arguments. Therefore, I designed the format of the assembler to be: Decimal address, Hex address, Hex op code, Hex operands/addresses, Label (added later — this is a one line assembler), Mnemonic (extended mnemonic set, see below), Operand (decimal, ofcourse, or label added later), then Comments (also added later). Since my output device is an IBM selectric that is in no way connected to my PET, I take the liberty of dressing up my listings at my leisure.

Now, to the program.

Since our intention is to divert the interrupt vector to our own purposes, the routine at 8000 (\$1F40) does just that. A SYS8000 done in immediate mode will cause the vector to be changed from its normal value to a value that will cause the PET to execute a routine located at 8016 (\$1F50) every time an interrupt occurs. This same routine will reverse that vector. This way, you only need to remember one number to set or reset the vector. This routine works like this: the instruction SEI causes the interrupt disable flag to be set, preventing the cpu from recognizing any interrupts. This is done to prevent an interrupt from occurring while we are half through altering the vector. There is no telling where the thing would go if we don't take this precaution! The LDY VEC-TOR + 1 instruction gets a byte of the current vector so we can determine whether it is the normal or the altered vector. Then we JSR to the SET subroutine which sets the normal vector. If the vector was already set to normal, then we have wasted a few microseconds, but I can wait. Then we compare the Y register to see if the vector was normal. If Y equals 230 (\$E6) then we JSR to the RESET subroutine and alter it. Else the BNE NOTSET causes execution to resume at 8014 (\$1F4E), the CLI clears the interrupt flag, enabling interrupts once again, and exits via the RTS back to BASIC.

Now that we have altered the vector,

the PET will execute the routine located at 8016 (\$1F50) every time an interrupt occurs, which happens sixty times a second. Let's examine this routine.

First we jump to a subroutine located at 62250 (\$F32A) which checks the keyboard and returns a zero in the accumulator if the STOP key is pressed. Upon return from that subroutine, we check the accumulator for zero, BEQ STOPPD. If the accumulator is zero, we jump to STOPPD, which is our recovery routine. If the accumulator is not zero we jump to CONINT, which is where the interrupt would normally have gone.

The instruction at 8024 (\$1F58) loads 8 into the X register, then uses this as a counter and displacement to pull 8 bytes off the stack and store them in memory beginning at location 8165 (\$1FE5). We pull 8 bytes off the stack instead of 6 because we assume at least one level of subroutine call beyond the interrupt. After all, we had to SYS or USR into our machine-language program, didn't we? We don't want the stack to get too cluttered. This isn't going to be a complete answer, but it will help. More will be said about this later.

Once we have stripped and saved the stack contents, we need to restore it. The routine beginning at 8033 (\$1F61) does this. First, we load and stack the high byte and low bytes of the BASIC warm-start routine. Then we recall the original value of the status register and stack it. This is important only because of the interrupt flag. Then we stuff the stack with three bytes of anything just to fill it out. After all, the interrupt handling routine thinks it has stored the accumulator and the X and Y registers on the stack; it will expect them to be there. Since we are not returning to the place where the interrupt occurred, we don't care what those bytes are, so let's just push the status byte onto the stack three more times.

Now that we have cleaned the stack and provided for a fake return from the interrupt, how about displaying the information thus recovered? Sounds easy, yes? Not so.

If we are to display our hard-won information, we can either write our own display routines or use the routines so conveniently provided for in ROM. Being naturally lazy, I much prefer to use the routines already written. But this is a problem. When I first wrote this program I got strange results that I eventually traced to the fact that the interrupt flag was being cleared somewhere, permitting the routine to be interrupted if I don't remove my finger from the STOP button within one sixtieth of a second. I discovered that at location 58816 (\$E5CO) in ROM there was a CLI instruction. Since

this is the print routine, I needed to find a way to use it without allowing the interrupt to screw things up. It was necessary to exit from our routine, return to BASIC, and then display our information. How to do it? I chose to use a TRICK!! Follow closely...

The PET has a keyboard buffer that collects keystrokes until the operating system can service them. This gives the effect of the PET "remembering" keystrokes even if you enter them while your program is doing something other than looking for INPUTs or GETs. If you load this buffer while in a machine language program and then exit to BASIC, the PET will suddenly "see" a command in its keyboard buffer and proceed to execute it.

After we recreate the stack and set the normal interrupt vector (JSR SET) then we load the keyboard buffer with the command "SYS8066cr". The "cr" is a carriage return. The instruction at 8049 (\$1F71) loads 9 into the X register. This number, which is the count for the buffer, is then stored in location 525 (\$020D). Then the command is retrieved byte by byte from location 8128 (\$1FC0) and placed in the keyboard buffer. When that is finished, the PET jumps to CONINT, the normal interrupt routine.

What follows is this: the PET updates the clock register, then jumps to the interrupt routine which restores the registers and "returns" to the BASIC warm-start routine. The prompt "READY." is printed, and control returns to BASIC. BASIC checks the keyboard buffer, sees the command "SYS8066", prints it and executes it. Control is now given to our display routine. Roundabout way of doing it, no?

The display routine begins at location 8066 (\$1F82). First we load the accumulator and Y register with the address of our header line. Then we JSR to the print routine in ROM at 51751 (\$CA27). After that we load the accumulator and X register with the bytes we stored that represent the interrupted return address, and JSR to the number display routine in ROM at 56479 (\$DC9F). This routine displays numbers in decimal, so if you wish them displayed in hex you will have to convert them yourself. Next, a loop is set up that retrieves each byte and displays them — first the status byte, then the accumulator, and the X and Y registers — all in decimal. At the end of all this wonderful activity, the routine exits through the START which alters the interrupt vector so we can do the whole thing over again.

Now, aren't you sorry you decided to read this?

## How to Load and Use This Program

Listing 1 is an assembly listing of this program. It may be of interest to people who enjoy machine-language programming, or those who like convoluted logic. It is difficult to enter machine-language programs into the PET, however. So I have provided listing 2, which is a BASIC version of this program. I have converted the machine-language program into DATA statements and built a small loader routine around them to make it easier to key into the PET and SAVE onto tape.

For those of you with the fortitude to attempt to enter this program into your PET, attend: First, this program will not work if your PET is one of the newer models. If your PET comes awake with `### COMMODORE BASIC ###` instead of `*** COMMODORE BASIC ***`, then forget this program. Rumor has it that you don't need it anyway. Second, if you still qualify, notice that each DATA statement has exactly eight numbers. If you key this program in exactly as shown it will be easier to find errors later if you miss-key a number.

OK. Are you still with me? Then key the program into your PET exactly as shown but do not RUN!! When finished, SAVE the program on tape. Then replace line 36 with:

```
36 FOR X=8000 TO 8159: READ A:
P=P+X*A:NEXT X:PRINT P
```

Now RUN the program. If the number printed is 146725222, then the odds are very good that you made no mistakes. You may now LOAD and RUN the original program. If, on the other hand, your number did not match the above number, then recheck your keypunching, correct your error, and try again.

NOTE: I would like to take this opportunity to encourage all programmers who write programs involving many DATA statements to include a verify routine. It need not be a permanent part of the program, but should be designed to give the hobbyist some solid evidence that his efforts were accurate.

Now you have LOAded and RUN the program. Notice that line 15 protects the last page of an 8K PET from interference by BASIC. This routine will reside safely here while you write your new machine-language program, debug it, and test it. I put this program in high memory because it is a machine-language debugging aid and most machine-language routines for the PET are located in the second cassette tape buffer area 826-1023 (\$033A-\$03FF) for convenience. If you wish to relocate it, be very sure you understand how it works.

Notice we have not yet activated this routine. First LOAD your machine-language program if you have it on tape, or your assembler if you are just starting. Then execute a SYS8000. This activates the Reset routine. From now on, whenever you hit the STOP key, the machine will halt and display the address where it was interrupted plus the register contents. There are a couple of exceptions which will be noted below.

OK. The Reset routine is activated, you have entered your machine-language program into the second cassette buffer, and executed a SYS826. Somehow the expected results do not materialize and the new program does not return control to BASIC. Now what? Hit the STOP key! Suddenly the PET comes back to life and prints:

```
ADDR ST AC XR YR
      835 34 129 66 202
```

Eureka! Somewhere around location 835 there was an error in your program. The status register contained 34, the accumulator had 129 in it, the X register had 66 and the Y register was holding a 202. Were they supposed to have these values? Perhaps a register was initialized wrong or a relative branch was figured wrong. At least you know where to begin looking. Isn't it wonderful?

If the STOP key is pressed during normal command mode, you will likely get:

```
ADDR ST AC XR YR
      58013 34 0 1 3
READY.
```

Notice that the numbers do not align perfectly under the header. They are printed without regard to the size of the number but are printed in the order depicted by the header, separated by blanks. Also, while it happens too fast to see, what actually printed was:

```
READY.
SYS8066
ADDR ST AC XR YR
      58013 34 0 1 3
READY.
```

The SYS8066 and the header are both prefaced with an up-cursor character, so that they are printed on top of each other. This makes less scrolling, in case the screen contents were important.

Now for the exceptions to the rules. Since it is impossible to know how deeply nested in subroutines the PET was when the interrupt occurred we cannot properly clean the stack. After a while (approx-

imately 23 times) pressing the STOP key will cause a ?OUT OF MEMORY ERROR remark to appear. The Reset routine will be deactivated and it will be necessary to SYS8000 again. Nothing to worry about; the PET corrected the stack before it printed the error message. Another message that will deactivate the Reset routine is ?ILLEGAL QUANTITY ERROR. Same response: SYS8000.

The command SYS8000 will activate the Reset routine if it was not already activated. If the Reset routine is active, SYS8000 will turn it off. Be sure it is on when you are executing your new machine-language program. And be sure it is off whenever you want to use the tape recorder to LOAD or SAVE a program or read or write data files. The cassette routines will not work if the interrupt vector has been altered. If in doubt as to the current status of the Reset routine, simply hit the STOP key. If nothing happens, the routine is off. If you get a register display, the routine is on.

One final exception to the rule. This routine is excellent if you get caught in an infinite loop or you just want to exit from a machine-language program early. It won't protect you from all invalid op codes. Some invalid op codes act like NOPs or do some mysterious, undefined function. These are OK. There are some op codes, however, that will cause the PET to lock up in spite of our marvelous Reset routine. Hex 04 will do this for example. I suspect that these obstinate op codes do something to affect the interrupt flag, thus disabling our routine. Until Commodore see fit to provide a non-maskable interrupt, I guess we will have to live with this inconvenience. But even so, it gives us a place to start looking, doesn't it? If your PET locks up in spite of the Reset routine, look for invalid op codes.

There you are. I hope this encourages more machine-language programming for the PET. Let's get full power out of our computers!

*For your free information regarding the extended mnemonic set that was referenced above, send a self-addressed and stamped envelope to:*

MICRO  
P.O. Box 6502  
Chelmsford, MA 01824

```

DEC HEX #1 #2 #3 LABEL MNEM OPER COMMENTS
8000 1F40 78 START SEI :Disable interrupts
8001 1F41 AC 1A 02 LDY VECTOR+1 :Get interrupt vector Hi byte
8004 1F44 20 AE 1F JSR SET :Set normal vector
8007 1F47 C0 E6 CPYIM 230 :Was normal vector already set?
8009 1F49 D0 03 BNE NOTSET
8011 1F4B 20 B9 1F JSR RESET :No - alter vector to CKSTOP routine
8014 1F4E 58 NOTSET CLI :Enable interrupts
8015 1F4F 60 RTS :Return to BASIC

Check if STOP key pressed
8016 1F50 20 2A F3 CKSTOP JSR STOP
8019 1F53 F0 03 BEQ STOPPD
8021 1F55 4C 85 E6 JMP CONINT
8024 1F58 A2 08 STOPPD LDXIM 8
8026 1F5A 68 SAVEM PLA
8027 1F5B 9D E4 1F STAX STK-1
8030 1F5E CA DEX
8031 1F5F D0 F9 BNE SAVEM

Recreate the stack
8033 1F61 A9 C3 RESTK LDAIM 195
8035 1F63 48 PHA
8036 1F64 A9 8B LDAIM 139
8038 1F66 48 PHA
8039 1F67 AD E9 1F LDA STATUS
8042 1F6A 48 PHA
8043 1F6B 48 PHA
8044 1F6C 48 PHA
8045 1F6D 48 PHA
8046 1F6E 20 AE 1F JSR SET

Create re-entry from BASIC warm start
8049 1F71 A2 09 LDXIM 9
8051 1F73 8E 0D 02 STX KNT
8054 1F76 BD BF 1F SETSYS LDAX SYS66-1
8057 1F79 9D 0E 02 STAX KBUF-1
8060 1F7C CA DEX
8061 1F7D 00 F7 BNE SETSYS
8063 1F7F 4C 85 E6 JMP CONINT

8066 1F82 A0 1F DISPLY LDYIM 31
8068 1F84 A9 CA LDAIM 202
8070 1F86 20 27 CA JSR ASPR
8073 1F89 AD E7 1F LDA LOC
8076 1F8C AE E8 1F LDY LOC+1
8079 1F8F 20 9F DC JSR DCPR
8082 1F92 A0 00 LDYIM 0
8084 1F94 8C ED 1F STY CNTR
8087 1F97 AC ED 1F ALLREG LDY CNTR
8090 1F9A C0 04 CPYIM 4
8092 1F9C F0 A2 BEQ START
8094 1F9E BE E9 1F LDY STATUS
8097 1FA1 A9 00 LDAIM 0

8099 1FA3 20 9F DC JSR DCPR :Display byte
8102 1FA6 EE ED 1F INC CNTR :Increment counter
8105 1FA9 4C 97 1F JMP ALLREG :Continue until done

8108 1FAC EA NOP
8109 1FAD EA NOP

SET and RESET subroutines
8110 1FAE A9 E6 SET LDAIM 230
8112 1FB0 A2 85 LDXIM 133
8114 1FB2 8D 1A 02 SAVIT STA VECTOR+1
8117 1FB5 8E 19 02 STX VECTOR
8120 1FB8 60 RTS
8121 1FB9 A9 1F RESET LDAIM 31
8123 1FBB A2 50 LDXIM 80
8125 1FBD 4C B2 1F JMP SAVIT

SYS8066 constants
8128 1FC0 91 SYS66 DC 145
8129 1FC1 53 DC 83
8130 1FC2 59 DC 89
8131 1FC3 53 DC 83
8132 1FC4 38 DC 56
8133 1FC5 30 DC 48
8134 1FC6 36 DC 48
8135 1FC7 36 DC 54
8136 1FC8 00 DC 13

8137 1FC9 EA NOP

DEC HEX #1 #2 #3 LABEL MNEM OPER COMMENTS
Header constants
8138 1FCA 91 HEADER DC 145
8139 1FCB 20 DC 32
8140 1FCC 41 DC 65
8141 1FCD 44 DC 68
8142 1FCE 44 DC 68
8143 1FCF 52 DC 82
8144 1FD0 20 DC 32
8145 1FD1 53 DC 83
8146 1FD2 54 DC 84
8147 1FD3 20 DC 32
8148 1FD4 41 DC 65
8149 1FD5 43 DC 67
8150 1FD6 20 DC 32
8151 1FD7 58 DC 88
8152 1FD8 52 DC 82
8153 1FD9 20 DC 32
8154 1FDA 59 DC 89
8155 1FDB 52 DC 82
8156 1FDC 00 DC 13
8157 1FDD 00 DC 0

:Up cursor
:Space
:A
:D
:R
:Space
:T
:Space
:A
:C
:Space
:X
:R
:Space
:Y
:R
:Carriage return
:End of message character
.....

```

Working storage -- need not be initialized

```

8165 1FE5 00      STK  DC   0      :Extra Hi byte
8166 1FE6 00      DC    DC   0      :Extra Lo byte
8167 1FE7 00      LOC  DC   0      :Interrupted Hi byte
8168 1FE8 00      DC    DC   0      :Interrupted Lo byte
8169 1FE9 00      STATUS DC  0      :Status byte
8170 1FEA 00      DC    DC   0      :Accumulator
8171 1FEB 00      DC    DC   0      :X register
8172 1FEC 00      DC    DC   0      :Y register

8173 1FED 00      CNTR DC   0      :Loop counter

```

Memory locations and ROM routines used

| LABEL  | DECIMAL | HEX       | COMMENT                                                                             |
|--------|---------|-----------|-------------------------------------------------------------------------------------|
| VECTOR | 537     | 0219      | Interrupt vector                                                                    |
| KNT    | 525     | 020D      | Keystroke counter                                                                   |
| KBUF   | 527-536 | 020F-0218 | Keyboard buffer                                                                     |
| BASIC  | 50059   | C38B      | BASIC warm start                                                                    |
| ASPR   | 51751   | CA27      | Print ASCII string terminated with a zero. Enter with ADH in Y, and ADL in A.       |
| DCPR   | 56479   | DC9F      | Print the decimal integer whose binary value is in A (weight=256) and X (weight=1). |
| CONINT | 59013   | E685      | Normal interrupt routine.                                                           |
| STOP   | 62250   | F32A      | Check to see if STOP key pressed. Returns a zero in accumulator if key is pressed.  |

```

1 REM"#####          *** RESET ***
2 REM"#####
3 REM"#####          WRITTEN BY:
4 REM"#####
5 REM"#####          GARY J. BULLARD
6 REM"#####          4808 S. ELWOOD
7 REM"#####          TULSA, OKLAHOMA
8 REM"#####          74107
9 REM"#####
10 REM"#####
11 REM"#####
15 POKE135,31:POKE134,64
16 DATA 120,172,26,2,32,174,31,192
17 DATA 230,208,3,32,185,31,88,96
18 DATA 32,42,243,240,3,76,133,230
19 DATA 162,8,104,157,228,31,202,208
20 DATA 249,169,195,72,169,139,72,173
21 DATA 233,31,72,72,72,72,32,174
22 DATA 31,162,9,142,13,2,189,191
23 DATA 31,157,14,2,202,208,247,76
24 DATA 133,230,160,31,169,202,32,39
25 DATA 202,173,231,31,174,232,31,32
26 DATA 159,220,160,0,140,237,31,172
27 DATA 237,31,192,4,240,162,190,233
28 DATA 31,169,0,32,159,220,238,237
29 DATA 31,76,151,31,234,234,169,230
30 DATA 162,133,141,26,2,142,25,2
31 DATA 96,169,31,162,80,76,178,31
32 DATA 145,83,89,83,56,48,54,54
33 DATA 13,234,145,32,65,68,68,82
34 DATA 32,83,84,32,65,67,32,88
35 DATA 82,32,89,82,13,0,234,234
36 FORX=8000T08159:READA:POKEX,A:NEXT
37 :
38 :
39 PRINT"ON SYS8000 TO TURN ON OR OFF."
40 PRINT"NOTE: THIS ROUTINE MUST BE TURNED OFF IF"
41 PRINT"IF CASSETTE I/O IS USED."
READY.

```

### Listing 2



# GREAT PET SOFTWARE

"Precise, humanized, well documented an excellent value" are the applauds now being given to United Software's line of software. These are sophisticated programs designed to meet the most stringent needs of individuals and business professionals. Every package is fully documented and includes easy to understand operator instructions.

**DATABASE MANAGEMENT SYSTEM** - A comprehensive, interactive system like those run on mainframes! Six modules comprising 42K of programming allow you to: create, edit, delete, display, print, sort, merge, etc.; etc. - databases of up to 10,000 records. Printer routines automatically generate reports and labels on demand. **60** pages of concise documentation are included. Requirements - 16-32K PET and 2040 Dual Disk (printer optional). . . . **Cost \$125**

**ACCOUNTS RECEIVABLE/PAYABLE** - A complete, yet simple to use accounting system designed with the small businessman in mind. The United Software system generates and tracks purchase orders and invoices all the way through posting "controlled" accounts payable and accounts receivable subsystems. Keyed Random Access file methods makes data access almost instantaneous. The low-cost solution for the first time computer user with up to 500 active accounts. Requirements - 32K PET, Dual Disk, any 80-column printer. . . . **Cost \$175**

**CASH RECEIPTS & DISBURSEMENTS** - Makes it a breeze to track all outgoing payments made by any type of business operation. Checks are tracked by number and categorized by type of expense. Sorting, summary, and audit trails make it easy to post to general ledger. This system also categorizes incoming receipts. Uses KRAM file access method. Requirements - 32K PET, Dual Disk (printer optional). . . . **Cost \$99.95**

**KRAM - Keyed Random Access Method** - The new, ultra-fast access method for the PET Disk, provides keyed retrieval/storage of data, in either direct or sequential mode, by either full or partial key values. Written by United Software in 6502 machine code, and designed with the PET in mind, it exploits all the benefits of the PET Disk, allowing full optimization of your system. Eliminates the need for "Sort" routines! KRAM provides flexibility never seen on a micro before. KRAM is modeled after a very powerful access method used on large-scale IBM Virtual Storage mainframes. So "KRAM" all you can into your PET - it will love you for it. . . . **Cost \$79.95**

(Sublicenses available to software houses.)

| PROGRAMS FOR ENTERTAINMENT          | Super Startrek . . . . .                     | 14.95   |
|-------------------------------------|----------------------------------------------|---------|
| Space Intruders                     | PET Music Box . . . . .                      | 29.95   |
| ("Best Game of 1979") . . . \$19.95 | <b>UNITED SOFTWARE PROGRAMS FOR BUSINESS</b> |         |
| Jury/Hostage . . . . .              | Checkbook . . . . .                          | \$15.95 |
| Kentucky Derby/Roulette . . . . .   | Mortgage . . . . .                           | 15.95   |
| Alien I.Q./Tank . . . . .           | Finance . . . . .                            | 12.95   |
| Tunnelvision/Maze Chase . . . . .   | Bonds . . . . .                              | 12.95   |
| Submarine Attack . . . . .          | Stock Analyzer . . . . .                     | 22.95   |
| Battle of Midway . . . . .          | Stock Options . . . . .                      | 24.95   |
| Laser Tank Battle . . . . .         | 6502 Macro Assembler . . . . .               | 49.95   |
| Swarm . . . . .                     |                                              |         |

Look for the RED-WHITE-BLUE United Software Display at your local computer dealer, or send check or moneyorder, plus \$1.00 shipping to:

**UNITED SOFTWARE OF AMERICA**  
750 Third Ave. Dealer inquiries invited  
New York, N.Y. 10017

## 6502 MACRO ASSEMBLER AND TEXT EDITOR

- Versions for PET, APPLE II, SYM, KIM and ATAR I (1st quarter 1980)
- Written entirely in **machine language**
- Occupies 8K of memory starting at \$2000 — Apple version with disk occupies just over 9K
- **Macro** and conditional assembly
- 36 error codes, 26 commands, 22 pseudo ops
- Labels up to 10 characters
- Auto line numbering and renumber command
- String search and string search and replace
- Copy, move, delete, load, save, and append commands

Cassette and Manual \$49.95  
(including U. S. postage)

### Eastern House Software

3239 Linda Dr.

Winston-Salem, N. C. 27106

## PET RABBIT

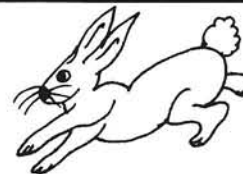

Load, Save, Verify, Execute  
8 K in 38 seconds versus  
PETs 2 Minute 45 seconds,  
**plus more!**

High-speed Cassette Routines work with 8K, 16K, or 32K **new ROM PETs** which have the new Commodore cassette deck (like the external version which sells for \$95.00). Note: If you have a new ROM PET with the old style lift-top deck, everything but the high-speed cassette routines will work.

- **Auto repeat** of any key held down, toggle character set.
- **RAM Memory Test**, convert #'s to hex and decimal.

### 12 Rabbit Commands

Note: Rabbit is 2K of machine code at \$1800 for 8K PETS, \$3000 or \$3800 for 16K PETS, or \$7000 or \$7800 for 32K PETS. (Specify one of the 5 versions.)

Cassette and Manual — \$29.95 (Add \$5.00 for foreign)

### Eastern House Software

3239 Linda Dr.

Winston-Salem, N. C. 27106

## TRAP 65

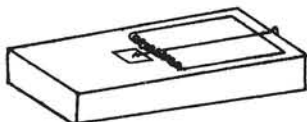

For PET, APPLE, SYM, OSI, etc.  
Any 1 mhz 6502!

- Prevents from "hanging up" via execution of **unimplemented opcodes!** Causes your monitor to **display location** of bad op code!
- Our computers have stopped crashing!
- **Debugging easier!**
- **Easy to install** — plugs into 6502's socket.

TRAP 65 is currently being used to insure that there are no bad opcodes in programs before submittal for ROM masks!

We are using TRAP 65 in experiments on extending the 6502's instruction set — PHX, PHY, INCD.

\$149.95 (Add \$4.00 postage, \$10.00 foreign)

### Eastern House Software

3239 Linda Dr.

Winston-Salem, N. C. 27106

## Finally, MAE — A PET DISK-Based MACRO ASSEMBLER/TEXT EDITOR

Works with 32K PET

- Works with 2040 Disk, and can drive 2022/2023 Printer, and/or RS232/20 ma Device thru User Port.
- 100% Disk Based, 100% Machine Language.
- Macros, Conditional Assembly, and a new feature we developed called Interactive Assembly.
- Coexists with Basic, Auto character repeat, Sorted Symbol Table.
- 27 Commands, 26 Pseudo Ops, 5 Conditional Ops, 38 Error Codes.
- Creates relocatable object code on disk.
- Assemble from Memory or Disk.
- String search, search and replace, and inter-line edit.
- Auto line #-ing, move, copy, delete, renumber.
- Labels up to 31 characters — user specifies length.
- Includes extension to PET monitor (disassemble, trace, etc.), Library of PET ROM locations, Relocating Loader, plus more.

Manual, Diskette, U. S. postage — \$169.95  
(Requires completion of License Agreement —  
Write for details)

### Eastern House Software

3239 Linda Drive

Winston-Salem, N. C. 27106



# The MICRO Software Catalogue: XVIII

Mike Rowe  
P.O. Box 6502  
Chelmsford, MA 01824

Name: **APPLESOFT-PLUS (APLUS) Structured Basic**  
Memory: **16K (min.)**  
Language: **6502 Assembly Language Standard (Disk, Autostart, and APPLESOFT ROM optional)**  
Hardware:

Description: You don't have to buy APPLE PASCAL to begin enjoying the benefits of structured programming. APPLESOFT PLUS (APLUS), a 4K assembly-language program, is now available to add the following structured-programming commands to APPLESOFT Basic: When..Else..Fin, Until, While, (multi-line) If..Fin, Unless, Case, Select (variable), (Otherwise), 'DO (named procedure)', and 'TO (define a named procedure). The APLUS '&CONVERT' command converts Applesoft programs that contain the above commands into standard Applesoft by replacing the structured-programming commands with appropriate 'GOTO' statements. The APLUS '&LIST' command automatically indents listings to clarify the logic flow inside a program. APLUS automatically checks for logic errors each time the Applesoft program is listed and allows start/stop/continue control of APLUS listings. APLUS also provides a separate list of all 'named procedures' used in a program. APLUS allows new Applesoft programs to be created without entering any 'GOTO's or 'GOSUB's. These Applesoft-Plus programs are then significantly easier to develop, maintain, and understand than 'regular' Applesoft programs. APLUS can also be used to maintain existing Applesoft programs without special conversion.

Price: **\$25.00**  
includes: **Cassette or disk with instructions**  
Available: **Sensible Software  
P.O. Box 2395  
Dearborn, MI 48123**

Name: **Integer BASIC Floating Point Interface (2.5K)**  
System: **APPLE II**  
Memory: **16K or more**  
Language: **Machine Language**  
Hardware: **Basic Apple II**

Description: The Integer BASIC Floating Point Interface, or IBFPI, is an integrated set of machine language routines which allows the user to indirectly use the Apple II Floating Point Utility Routines. The first eight variables defined in an Integer BASIC program allow floating point variables and arrays to be referenced from within an Integer BASIC program. IBFPI also includes utility routines for floating point exponentiation, input, and output. IBFPI FP output allows Fortran-like field widths. Arithmetic errors are processed automatically, and when an error is detected, an error message is printed and the current Integer BASIC line is displayed. The eight-page documentation includes features, background, program cassette operation, programming, page zero usage, error messages, structure, and notes. A demonstration program is included and is explained in the operation part of the documentation.

Copies: **7 delivered**  
Price: **\$8.95** postpaid  
Includes: **Cassette and documentation**  
Author: **Harry L. Pruetz**  
Available: **Microspan Software  
P.O. Box 9692  
Austin, TX 78766**

Name: **Restaurant Food/Beverage Analysis and Menu Pricing**  
System: **APPLE II**  
Memory: **16K**  
Language: **APPLESOFT II (ROM or RAM)**

Description: A self-prompting program that establishes menu prices of virtually any food/liquor item. Predetermined, and industry proved, percentages in the program define what the menu price should be in order to make an acceptable profit. The program may be utilized both for initiating a new or revising an existing menu. Re-evaluates existing menu prices and indicates what present food/liquor costs are. Takes the guess work out of menu development. No intelligent restaurateur should be without this aid.

Price: **\$14.95 Diskette, \$9.95 Cassette, \$5.95 Listing**, plus \$1.00 postage and handling.

Author: **M. Goldstein**  
Available: **Mind Machine, Inc.  
31 Woodhollow Lane  
Huntington, N.Y. 11743**

Name: **Disk Utilities**  
System: **APPLE II**  
Memory: **48K with APPLESOFT ROM**  
Language: **APPLESOFT/MACHINE**

Description: Disk Utilities is a set of 3 programs: One Drive Copy, Disk Statistics, and Patch. One Drive Copy allows disks to be copied on a system with only one disk drive. Disk Statistics displays the unused sectors of a disk as a number and a percentage of the total. Patch is a powerful tool that allows the reading, displaying (in ASCII and HEX), modification and writing of any sector on a disk.

Price: **\$19.95** on diskette with user manual.

Author: **Hal Clark**  
Available: **ON-GOING IDEAS  
P.O. Box 132  
Rosemount, MN 55068**

MN residents please buy at your local APPLE dealers.

Name: **AIM Microchess**  
System: **AIM 65**  
Memory: **2K**  
Language: **Assembly**

Description: An AIM version of Microchess, Peter Jennings' original chess program for the 6502. This version features several keyboard selectable speeds, a chess clock, optional printout of the current chessboard, display of moves in standard chess notation, and more. A great way to "show off" your AIM, as well as a means to learn more about using your AIM since source listings are provided.

Copies: **AIM version, just released. KIM version, thousands!**  
Price: **\$15.00**  
Includes: Cassette tape object, operating instructions, commented source listing.  
Authors: Mel Evans - AIM Version  
Peter Jennings - Original  
Available: MICRO Software  
P.O. Box 6502  
Chelmsford, MA 01824

Name: **Micro Memo**  
System: **APPLE II**  
Memory: **48K**  
Language: **RAM or ROM Applesoft**  
Hardware: **Optional**—Mountain Hardware Clock (any slot) and/or any APPLE compatible printer

Description: Micro Memo is a powerful "desk calendar" program. It can handle one-time, weekly, monthly, semi-annual, and annual reminders. Monthly reminders may be for fixed dates (e.g., the 15th of the month) or "floating" dates (e.g., the 1st Saturday of every month). Each reminder allows you the choice of 1 week, 2 week or 1 month advance notice, so the system can remind you ahead of time to prepare for meetings, purchase birthday presents, make reservations, etc. The program will print out or display any day's or week's reminders, including most major holidays. This is a "perpetual" calendar which automatically creates new months with all appropriate reminders (birthdays, anniversaries, monthly meetings, etc.) as past months are dropped. The system holds a full year's reminders (beginning with any month) on one disk.

Price: **\$39.95**  
Includes: Disk with program and 6 pages of documentation, including information on custom modifications.  
Author: **Barney Stone**  
Available: **STONEWARE**  
Microcomputer Software  
P.O. Box 7218  
Berkeley, CA 94707

Name: **IBM PRINT**  
System: **APPLE II or APPLE II PLUS, Disk II and IDS 440 Printer**  
Memory: **16K with ROM—32K without**  
Language: **APPLESOFT II**

Description: IBM Print is a simple utility program for printing "TEXT" files with ANSI standard carriage control characters in column one of the records. This capability allows the user to create files for printing with overprint and paging capabilities using any text editor or program. The program is most useful for local printing of large files created on main-frames and moved to the APPLE using the terminal communications program: MOVE 370. This technique allows the user to create large print files using IBM's very powerful word processing systems, move them to the APPLE, and then print them locally. The program is easy to use and easy to modify for other brands of printers.

Price: **\$20.00**  
Includes: One diskette and program  
Author: **Gary M. Grandon, Ph.D.**  
Available: Rosen Grandon Associates  
296 Peter Green Road  
Tolland, CT 06084

Name: **Wilderness Campaign**  
System: **APPLE II**  
Memory: **48K**  
Language: **Integer Basic**

Description: Wilderness Campaign is a game of high adventure in which you undertake a crusade to free the kingdom of Draconia from the Evil Necromancer that is tyrannizing it. As you direct your party across the high resolution graphics map of Draconia, you must overcome obstacles, defeat hostile inhabitants, survive various natural hazards (avalanches, quicksand, etc.) and explore numerous tombs, temples, castles, and ruins in search of gold and magical devices. When treasure is found, you will go to nearby villages to hire men and purchase weapons, armor, and assorted useful supplies. The supplies and any magical devices that you find will aid you in your ultimate quest: to find the ancient weapons of power required to defeat the Necromancer. Once you have found the required magical weapon and have gathered and equipped a suitable army, you are ready to attack the fortress of the Necromancer itself. The future of Draconia rests on your shoulders.

Copies: **Many**  
Price: **\$15.00 cassette, \$17.50 disk** (WA residents add 5.3% sales tax)  
Author: **Robert C. Clardy**

Available: Synergistic Software  
5221—120th Ave. S.E.  
Bellevue, WA 98006  
(206)641-1917

Name: **MAE Development Software**  
System: **32K ROM PET and 2040 Disk Drive**  
Memory: **10K**  
Language: **Machine Language**

Description: A new Assembler/Editor and associated development software to be used for developing programs in assembly language on the new ROM 32K PET and 2040 Disk Drive. No tape is supported. User has option of connecting an external CRT or TTY to obtain 80 column display operation. Features include MACROS, Conditional Assembly, and Interactive Assembly. The MAE ASSM/TED occupies 10K memory starting at \$5000 and handles labels up to 31 characters. Includes relocating loader plus a copy of the loader in relocatable form so it can be relocated practically anywhere in RAM memory.

Copies: **Just Released**  
Price: **\$169.95** postpaid in U.S.—requires completion of software license agreement.  
Includes: Diskette and Manual  
Author: **C.W. Moser**  
Available: Eastern House Software  
3239 Linda Drive  
Winston-Salem, N.C.  
27106

Name: **One-Arm Bandit**  
System: **APPLE II**  
Memory: **32K**  
Language: **Integer Basic**  
Hardware: **APPLE II (32K), Integer Basic, Video Monitor or TV**

Description: One-Arm Bandit is a slot machine program for one to four players. It uses a combination of text graphics, low-res color graphics and sound effects to display a realistic one arm bandit. Pay off odds are based on those of a real slot machine. The program also displays many personalized messages and keeps track of each player's winnings or losses. See and hear the wheels turn when you pull the bandit's arm. Three "ORANGES"—YOU WIN!.

Price: **\$9.95** for cassette, **\$14.95** for disk (Listing included)  
Authors: **Ken and Dawn Ellis**  
Available: Progressive Computer Software  
405 Corbin Road  
York, PA 17403

Name: **ROSTER**  
 System: **APPLE II**  
 Memory: **48K**  
 Language: **APPLESOFT II**  
 Hardware: **APPLESOFT ROM Card, Disk II, Printer**

Description: A general purpose disk-based record-keeping program for teachers at all levels. Allows instructors to create and change class rosters, label, enter and change test or assignment scores, sort roster based on student number, student name, or rank in class, assign character or numeric grades based on any of five criteria (raw score, percent, rank, percent rank, or z-score), and list scores, totals (or averages), and/or grades according to any of these options. The program will (at the instructor's option) automatically weight each score's contribution to the student's cumulative total (or mean), and/or drop the lowest (weighted or unweighted) score from among a selected group of scores prior to grade assignment. Two separate list formats are available. A class roster list prints the name of the class, section, term, etc., student numbers and any or all of the following: student names, individual scores (as raw scores, percents, ranks, percentile ranks, or z-scores), totals (or means) of individual scores (using the weighting or drop options, if requested), and assigned grades (according to user-entered grading scale). Means and standard deviations for each selected item are printed automatically. The individualized student list prints any or all of the above statistics for each test or assignment separately (particularly useful for student or parent consultation). Program is password protected (you enter your own password).

Copies: **Just released**  
 Price: **\$39.95**  
 Includes: Software on disk, listing, documentation, and user's manual  
 Available: **Dr. Douglas Eamon**  
 105 West Oak Street  
 Albion, MI 49224

Name: **Higher Graphics**  
 System: **APPLE II**  
 Memory: **32K**  
 Language: **Integer Basic**  
 Hardware: **Disk Drive**

Description: A collection of programs and shape tables that lets any programmer create detailed and beautiful high resolution displays and animation effects. Make your programs come alive by utilizing the full graphical capabilities of the Apple II. Package contains: Shape Maker—create, correct, or delete shapes, start new shape tables or add to existing ones, display any/all shapes with any scale or rotation at any time. Table Combiner—pull shapes from existing general purpose tables and add the ones you want. Screen Creator—place your shapes on the high-res screen, add areas of color and text to make detailed displays etc. Shapes—four shape tables with over 100 shapes are provided. High Res Text—how to use high resolution graphics in your program. Animation effects and display techniques.

Copies: **Many**  
 Price: **\$25.00** (WA residents add 5.3% sales tax)  
 Author: **Robert C. Clardy**  
 Available: Synergistic Software  
 5221 —120th Avenue, S.E.  
 Bellevue, WA 98006

Name: **PET RABBIT**  
 System: **16K or 32K New ROM PET**  
 Memory: **2K**  
 Language: **Machine Language**

Description: Provides 12 commands which can be executed in Basics direct mode plus provision of automatic repeat of any key (including cursor control keys) held down for 0.5 seconds. Rabbit provides fast load and save commands (38 seconds versus 2 minutes 44 seconds for PET to record 8K memory), an exhaustive memory test, convert hex to decimal and vice versa, plus more. Specify memory location as: \$3000, \$3800, \$7000, or \$7800.

Copies: **Just Released**  
 Price: **\$29.95 postpaid**  
 Includes: Manual and Cassette  
 Authors: **J.R. Hall and C.W. Moser**  
 Available: Eastern House Software  
 3239 Linda Drive  
 Winston-Salem, N.C.  
 27106

Name: **Matrix Manipulator**  
 System: **APPLE II or APPLE II Plus**  
 Memory: **32K Minimum**  
 Language: **ROM Applesoft**  
 Hardware: **Disk II (opt.) Printer (opt.)**

Description: Matrix Manipulator is an interactive program having the following modes; add, subtract, multiply, invert, transpose, scalar multiply, square root, orthonormalization, row reduce, column augment, input, edit, display/print, to/from disk, and 11 other modes. Matrix names and sizes are user definable, typified by 15 (32K) or 40 (48K) 10x10 matrices in use at once with DOS active. User's guide explains modes and applications to linear system solutions, etc. Program is supplied in two versions, one with in-line instructions.

Price: **\$24.95 disk**  
**\$22.95 tape** plus 4.5% Ohio tax in Ohio  
 Includes: Both program versions and User's Guide  
 Author: **Robert Rennard**  
 Available: SmartWare  
 2281 Cobble Stone Ct.  
 Dayton, OH 45431

Name: **MOVE 370**  
 System: **APPLE II or APPLE II PLUS, Disk II and Communications**  
 Memory: **16K with ROM—32K without**  
 Language: **APPLESOFT II**

Description: MOVE 370 is a telecommunications interface program for moving complete "TEXT" files to and from IBM 370 systems. The program communicates with IBM's interactive CMS EDITOR (or other IBM editors with minor modifications) to pass files to or from the IBM system from the remote APPLE II. This capability enables the user to treat the Micro as a genuine distributed processor for data-entry and other off-loaded applications. It's easy to use and easy to modify.

Price: **\$20.00**  
 Includes: One diskette plus program  
 Author: **Gary M. Grandon, Ph.D.**  
 Available: Rosen Grandon Associates  
 296 Peter Green Road  
 Tolland, CT 06084

#### Software Catalogue Note

Do you have a software package you want publicized? Our Software Catalogue is a good opportunity to receive some free advertisement. This regular feature of MICRO is provided both as a service to our readers and as a service to the 6502 industry which is working hard to develop new and better software products for the 6502 based system. There is no charge for listings in this catalogue. All that is required is the material for the listing be submitted in the listing format. All information should be included. We reserve the right to edit and/or reject any submission. Some are too long; so please, be brief and specific. We might not edit the description the same way you would.

**Decision  
Systems**



*Presenting the Other Side of the Apple II\**

- ISAM-DS** An integrated set of routines for the creation and manipulation of indexed files. Retrieve records sequentially by key value or partial key value. Files never have to be reorganized.  
Requires: Disk, Applesoft (32K ROM or 48K RAM)  
\$50
- PBASIC-DS** A sophisticated preprocessor for structured BASIC. Gain the power of PASCAL-like logic structures at a fraction of the cost. Use all regular BASIC statements plus 14 commands and 9 new statements/structures (WHILE, UNTIL, CASE, etc.) Works with INTEGER or APPLESOFT programs.  
Requires: Disk, Applesoft (32K ROM or 48K RAM)  
\$35
- UTIL-DS** An Applesoft utility package that includes improved error interrupt handling (return to the statement following the one in error), a routine that selectively clears array variables (for reDIM or chaining), an interface routine that provides a 'GOSUB' facility from machine language to Applesoft and an advanced formatting routine for printing numeric values. Works with negative values; inserts commas in value, etc. Also contains a loader to put the routines into RAM with your program.  
Requires: Disk, Applesoft (ROM of RAM)  
\$35

(Texas residents add 5% tax)

**Decision Systems**  
P. O. Box 13006  
Denton, TX 76203

\*Apple II is a registered trademark of the Apple Computer Co.

## MUSICAL COMPUTER I AND II

### Learn How to Read Music!

Music lessons taught you in your home or at a studio cost from \$7 each half-hour and up! Now, available to you Apple II owners, is an opportunity for you to have your private music teacher in the comfort of your own home.

Written by a M.A. educator with over 20 years of music experience, this two-program cassette provides an *alternative* to music education!

These programs, utilizing high resolution graphics and a 16K Apple II, will make music learning fun and enjoyable for the entire family!

*Apple II is a TM of Apple Computers, Inc.*

**COMPUTER  
APPLICATIONS  
TOMORROW**

**P.O. Box 7000-363  
Palos Verdes, CA 90274**

Name: .....

Address: .....

City, State, zip: .....

**Send Check or Money Order for \$34.95 plus \$1.00  
postage and handling.  
(CA residents add 6% sales tax)**

## KIM/SYM/AIM-65—32K EXPANDABLE RAM DYNAMIC RAM WITH ON BOARD TRANSPARENT REFRESH THAT IS COMPATIBLE WITH KIM/SYM/AIM-65 AND OTHER 6502 BASED MICROCOMPUTERS.

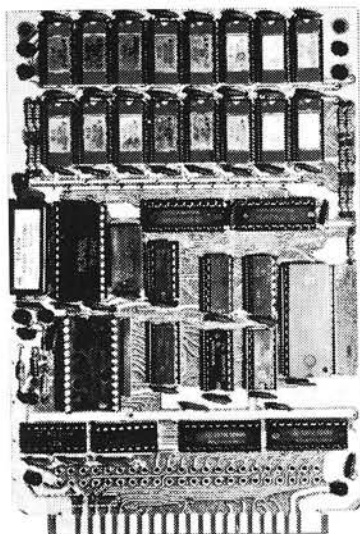

|                      |                                          |          |
|----------------------|------------------------------------------|----------|
| ASSEMBLED/<br>TESTED | WITH 32K RAM .....                       | \$419.00 |
|                      | WITH 16K RAM .....                       | \$349.00 |
|                      | WITHOUT RAM CHIPS .....                  | \$279.00 |
|                      | HARD TO GET PARTS ONLY (NO RAM CHIPS) .. | \$109.00 |
|                      | BARE BOARD AND MANUAL .....              | \$49.00  |

- \* PLUG COMPATIBLE WITH KIM/SYM/AIM-65. MAY BE CONNECTED TO PET USING ADAPTOR CABLE. SS44-E BUS EDGE CONNECTOR.
- \* USES +5V ONLY (SUPPLIED FROM HOST COMPUTER BUS). 4 WATTS MAXIMUM.
- \* BOARD ADDRESSABLE IN 4K BYTE BLOCKS WHICH CAN BE INDEPENDENTLY PLACED ON 4K BYTE BOUNDARIES ANYWHERE IN A 64K BYTE ADDRESS SPACE.
- \* ASSEMBLED AND TESTED BOARDS ARE GUARANTEED FOR ONE YEAR, AND PURCHASE PRICE IS FULLY REFUNDABLE IF BOARD IS RETURNED UNDAMAGED WITHIN 14 DAYS.
- \* BUS BUFFERED WITH 1 LS TTL LOAD.\*
- \* 200NSEC 4116 RAMS.
- \* FULL DOCUMENTATION

### PET INTERFACE KIT \$49.00

CONNECTS THE ABOVE 32K EXPANDABLE RAM TO A 4K OR 8K PET.  
CONTAINS EXPANSION INTERFACE CABLE, BOARD STANDOFFS,  
POWER SUPPLY MODIFICATION KIT AND COMPLETE INSTRUCTIONS.

**6502, 64K BYTE RAM AND CONTROLLER SET**  
MAKE 64K BYTE MEMORY FOR YOUR 6800 OR 6502. THIS CHIP SET INCLUDES:  
\* 32 M5K 4116-3 16KX1, 200 NSEC RAMS.  
\* 1 MC3480 MEMORY CONTROLLER.  
\* 1 MC3242A MEMORY ADDRESS MULTIPLEXER AND COUNTER.  
\* DATA AND APPLICATION SHEETS, PARTS TESTED AND GUARANTEED.  
**\$325.00 PER SET**

**16K X 1 DYNAMIC RAM**  
THE MK4116-3 IS A 16,384 BIT HIGH SPEED NMOS, DYNAMIC RAM. THEY ARE EQUIVALENT TO THE MOSTEK, TEXAS INSTRUMENTS, OR MOTOROLA 4116-3.  
\* 200 NSEC ACCESS TIME, 375 NSEC CYCLE TIME.  
\* 16 PIN TTL COMPATIBLE.  
\* BURNED IN AND FULLY TESTED.  
\* PARTS REPLACEMENT GUARANTEED FOR ONE YEAR.  
**\$8.50 EACH IN QUANTITIES OF 8**

**BETA**  
COMPUTER DEVICES

1230 W. COLLINS AVE.  
ORANGE, CA 92668  
(714) 633-7280

CALIF RESIDENTS PLEASE ADD 6% SALES TAX.  
MASTERCARD & VISA ACCEPTED. PLEASE  
ALLOW 14 DAYS FOR CHECKS TO CLEAR BANK.  
PHONE ORDERS WELCOME.

**ALL ASSEMBLED BOARDS AND MEM-  
ORY CHIPS CARRY A FULL ONE YEAR  
REPLACEMENT WARRANTY.**

# 6502 Bibliography: Part XVIII

Dr. William R. Dial  
438 Roslyn Avenue  
Akron, OH 44320

## 554. Call Apple 2, No. 6 (July/August 1979)(cont'd)

- Neulen, Bob and Golding, Val. "Change Catalog to C," pg. 30.  
A short utility...but watch out playing WUMPUS with that C.
- Golding, Val J. "Monitor String Writer," pg. 32.  
Two programs for converting machine language to HEX Strings and writes them into program memory automatically, one each for Integer Basic and for Applesoft Basic.
- Dunmire, Darrell. "The Missing Link," pg. 34.  
LINK was incompletely listed earlier; now it is complete.
- Anon. "HIRES Dump," pg. 36.  
Mod for centering with Parallel Card, for the Apple.
- Wagner, Roger. "Exceeding the Speed Limit with your Apple II," pg. 36.  
How to coax more speed out of the Apple.

## 555. Creative Computing 5, No 9 (September 1979)

- Anon. "Apple Cart 3-D Graphics," pg. 17.  
Program missing in July Apple-Cart article.
- Scarpelli, Anthony T. "A 6502 Disassembler in Microsoft BASIC," pg. 124-129.  
A program that will disassemble the 6502 op-codes, printing out the op-code, address, data, all in hex and the mnemonics and addressing mode.
- Piele, Donald T. "Micros 'GOTO' School," pg. 132-134.  
Discussion of the use of the Apple II in school computer programs.
- Hunter, Jim. "A Grade Maintenance Program for the Apple II with Disk Drive," pg. 142-149.  
Maintaining accurate grades in school computer systems.
- Tubb, Philip. "Q and A - The 'Tiny' Interpreter Exercise," pg. 161-176.  
Discussion of Applesoft Basic.
- Yob, Gregory, "Personal Electronic Transactions," pgs. 178-182.  
Discussion of the "Basic Programmer's Toolkit, the Structure of Basic, encrypted messages on the PET.

## 556. PET User Notes 2 No. 1 (Jan/Feb 1979)

- Beals, Gene, "New Commodore Products," pg. 2.  
Discussion of new model PETs, etc.
- Covitz, F., "Visible Memory," pg. 4.  
Control individual pixels on the PET screen with the Visible Memory board, and PET interface.
- Butterfield, Jim, "Watching a Cassette Load," pg. 7.  
Procedure for visible loading of a program from cassette tape.

- Wuchter, Earl, "Controlled Restore," pg. 7.  
Routine to reset the DATA pointer to the beginning of any DATA line.
- Zimmermann, Mark, "ROM Subroutines," pg. 11.  
Some of the ROM subs of the PET are revealed.
- Swan, Warren, "Machine Language Routines for Fast Graphics," pgs. 13-19.  
Seven routines including a demo.
- Russo, Jim, "Single-Step Routine," pg. 16.  
MT6671 is a machine-language monitor program incorporating a single-step trace feature.
- Velders, Jerry A. "PLOT," pg. 18-19.  
Machine-language plot routine which is faster than an equivalent Basic routine.
- O'Brien, Roy, "Ramblin'," pgs. 20-21  
How the CB2line of the PET's VIA chip (6522) can be used for generating musical tones.
- Velders, Jerry A., "Memory Test," pg. 22.  
MTEST is a Non-destructive Memory test.

## 557. Dr. Dobb's Journal 4, Iss.8 (Sept. 1979)

- Zant, R.F., "Modular Programming with the Apple II," pgs. 37-38.  
The modular approach to programming encourages the use of common routines in different programs.

## 558. Washington Apple Pi 1, No. 7 (August 1979)

- Dial, William R., "6502 Information Resources," pg. 2.  
Reprinted from MICRO and updated by Mark Crosby.
- Cirillo, Nicholas B., "Changing 'Beneath Apple Manor'," pgs. 3-4.  
A way to interrupt the commercial program, Apple Manor, and save data so that it can be resumed later.
- Moon, John L., "APPLE Programming With Style," pgs. 4-5.  
How to structure a program, add a menu, etc.

## 559. Rainbow 1, No. 7, (August, 1979)

- Simpson, Rick, "Introduction to Machine Language Programming," pgs. 1-5.  
The internal structure of the 6502 itself is discussed.
- Landereau, Terry, "What's the Difference," pg. 7.  
Discusses the differences in the terms assembler, interpreter, compiler, source code, object code, etc. for the Apple.
- Wright, Walter, "Modifications to Gary Dawkin's Shape Drawing Program," pg. 8.  
A version modified for the Programmer's Aid ROM No. 1 of the Apple.

- Blue, Bill and Massimo, Alex, "Applesoft Program for Lower Case Letters with Dan Paymar's Lower Case Adapter Installed," pg. 13.  
Short listing—the title tells it all.
- Blue, Bill and Massimo, Alex, "Stop the Cursor Flashing," pg. 15.  
Simple hardware mod. for the Apple.
- Blue, Bill and Massimo, Alex, "Keyboard Mod for Faster Cursor Control," pg. 16.  
Simple hardware mod to move the cursor faster on the Apple.
- 560. 73 Magazine, No. 228 (September, 1979)**
- DeJong, Marvin L., "Build the KIM Keyer," pgs. 80-84.  
With a simple interface and a short application program the KIM-1 can send any of three messages entered into memory.
- 561. Byte 4, No. 9 (September 1979)**
- Teeters, Jeff, "Interface a Chessboard to your KIM-1," pgs. 34-54.  
By using a specially electrified chessboard, the KIM-1 can be used, avoiding keyboard entry of moves.
- O'Haver, T. C., "A Similarity Comparator for Strings," pgs. 58-60.  
A program comparing strings or doing searches reports 'best' match if no exact match is found. In OSI Microsoft Basic.
- Hallgren, Richard C., "A Low-Speed Analog-to-Digital Converter for the Apple II," pgs. 70-78.  
Hardware and two software routines.
- Powers, William T., "The Nature of Robots: Part 4: Looking for Controlled Variables," pgs. 96-112.  
An Apple II graphics program is given to simplify a control-variable simulation.
- 562. The Paper 2, Iss. 3 (August 1979)**
- Sparks, Paul W., "An Inexpensive Printer Option," pg. 3.  
Interfacing the SWPTC PR-40 printer with the PET.
- Busdiecker, Roy, "6502 Relocating Macro Assembler/Test Editor 1.0," pgs. 7-8.  
A review of a PET program.
- Busdiecker, Roy, "Odds and Ends," pg. 9.  
Discusses the PET ROM Monitor, the care of cassettes, renumber program, etc.
- Anon, "Forth and Backwards," pgs. 12-13.  
Discussion of PETFORN and other versions of Forth.
- Wachtel, A., and Szepesi, Z., "The Development of a Basic Program," pgs. 14-15.  
Illustration of the many ways a program can be improved.
- Busdiecker, Roy, "Computers Do It In Binary," pgs. 22-24.  
The second in a series of articles on computer arithmetic.
- 563. Abacus 1, Iss. 8 (August 1979)**
- Anon, "Routine to Center Titles," pg. 2.  
Short utility for the Apple II.
- Anon, "Integer Basic Internals," pgs. 3-5.  
A list of Variables used by Basic and Integer Basic Subroutines for the Apple.
- Hertsfeld, Andy, "Text File Mover," pg. 4.  
How to get a text file from one disk to another on the Apple.
- Staff, "Super HI-RES," pg. 4.  
A short listing for the Apple Hires Graphics.
- Avelar, Ed, "Survey Analysis," pgs. 7-8.  
Analyzes data for number of responses in each category, etc.
- Paymar, Dan, "Disc Access Utility," pgs. 9-10.  
Allows you to dump the contents of any specified sector and track. Useful for recovering crashed disks, on the Apple.
- Hyde, Randy, "The Apple Monitor," pgs. 11-12.  
Description of routines and registers affected by calling the routine.
- Crosby, Mark, "Changing 'Catalog' to 'C'," pg. 12.  
Two short listings for Apple DOS 3.1 and 3.2.
- Staff, "Convert Decimal Input to Hex Output," pg. 12.  
Short Applesoft routine for the Apple II.
- Staff, "Use of Control Y with Parameter on the Apple," pg. 14.  
Demo of Control Y and the Apple Paddles.
- Staff, "Statistics Programs," pg. 15.  
A routine for the Hello program for the Apple that will bring up a menu and allow a given program to be selected. Example is with the Osborn list of statistics programs.
- 564. The Seed 1, No. 3 (August 1979)**
- Staff, "Documentation Library," pgs. 3-9.  
In addition to maintaining a large program library, The Apple Pi user Group of Denver, CO has published an extensive list of User Group publications and Lists of documentation of Apple programs available for copying.
- Borgerding, Jim, "Star Location," pg. 12.  
Locate stars with the Apple.
- Egan, Linda, "Hires Shape Generator," pg. 17.  
An integer program to go with the Apple Programmer's Aid No. 1.
- McClure, Allen and Taylor, T.N., "Disc Speed Adjustment with the DSPEED Programs," pg. 18.  
Adjust the speed of your Apple II disk drive.
- Anon, "B/BSTAT Change," pg. 21.  
A few simple changes of variables will insure that B/BSTAT will work on Apple DOS 3.2.
- 565. 6502 User Notes, No. 16 (September 1979)**
- Martin, Richard, "Four Part Harmony," pgs. 1-4.  
This KIM-1 music program plays on an unexpanded KIM-1.
- Adams, Jim, "Circular List Processing Subroutines.," pgs. 5-6.
- Hawkins, George W., "Pong Sound Effects," pg. 8.  
Add BEEP, BOOP and ZONK sounds to your KIM programs.
- Leedom, Robert, "Baseball for the KIM," pgs. 10-11.  
A video style action game for the KIM-1.
- McKenna, Sean, "Language Lab," pgs. 12-19.  
An Editor for Microsoft Basic.
- Clements, William C., "Adding a Cassette Interface to Focal," pgs. 14-16.  
Add a cassette interface and User function to Focal 65-E.
- Mulder, Bernhard, "Focal LED Output," pg. 17.  
This routine makes KIMs, LEDs another output device.
- Allen, Michael, "TVT-6/TINY BASIC Interface," pgs. 18-19.  
How to get Tom Pitman's Tiny Basic to work with the KIM-1/TVT-6 combination.
- McKenzie, Bruce, "SYM On-Board Speaker Toggle Routine," pg. 21.  
A routine to invert the state of the SYM speaker, producing an audible tone.
- Davidson, Al, "Some Useful AIM Notes," pgs. 21-23.  
How to make the AIM 65 run at MHz; AIM and KIMSI hints; etc.
- Breson, Steve, "AIM Tape Problems," pg. 22.  
Hints on using the AIM Tape interface.
- Butterfield, Jim, "Personal Views on How Aim Compares...," pg. 23.  
Point by point comparisons with PET and KIM.

Boisvert, Conrad, "A Couple of 6522 Applications Notes," pg. 24.

SY6522 Generating Long Time Intervals and SY6522 use in Generating a 1Hz Square-Wave Signal.

Solomon, Robert, "Read KIM Tapes on Your OSI System," pgs. 26-27.

How to take advantage of the large supply of KIM software using your OSI system.

#### 566. MICRO 16, (September 1979).

Sherburne, John, "Plotting a Revolution," pgs. 5-10.

A PET Basic program for plotting.

DeJong, Dr. Marvin L., "An AIM-65 Notepad," pgs. 11-13.

Several assembly language programs that may be used to display input/output information.

Childress, J.D., "Applesoft Renumbering," pgs. 15-16.

A fast and reliable utility for Apple programmers, adaptable to PET and other Microsoft BASIC systems.

Herman, Prof. Harvey B., "MOVE IT: Relocating PET Source Programs and Object Code," pgs. 17-19.

Let the PET move it—this article tells how.

Auricchio, Richard R., "Life in the Fast Lane," pgs. 21-24.

A high speed version of the game of LIFE. For the Apple.

Faris, Stephen J., "SYM-1 Event Timer," pgs. 26-27.

A 100 KHz event timer using the on-board 6532 can handle up to 50 elapsed time intervals or successive timed events.

DeJong, Dr. Marvin L., "AIM-65 in the Ham Shack," pgs. 29-31.

A message transmitter and keyer which will accept and save messages to be transmitted automatically on request.

Husbands, Charles R., "Speech Processor for the PET," pgs. 35-39.

Digitized speech can be stored, cataloged, processed as discrete data, and output through a D/A converter.

Vrtis, Nicholas, "Tiny PILOT: An Educational Language for the 6502," pgs. 41-48.

PILOT, a higher level language used for computer aided instruction, for the 6502, including an editor and an interpreter.

Rowe, Mike (staff), "The Micro Software Catalog: XII," pgs. 51-52.

Eight programs are reviewed.

McCreary, Dann, "8080 Simulation with a 6502," pgs. 53-56.

How your micro can assist program development for other machines.

Spilman, Shawn, "Writing for MICRO," pgs. 59-62.

6502 enthusiasts should try their hand at contributing articles for publication.

#### 567. Stems from the Apple 2, Iss. 8 (August 1979).

Hoggatt, Ken, "Ken's Korner," pg. 2.

How to check for duplicates in a file. For the Apple.

Smith, Eric, "Scientific Programming 1," pg. 3.

Circle and spiral plotting in Hires on the Apple.

Anon, "Dick Sedgewick's New Computing Language, IMA," pg. 4.

IMA is an anarcism for Integer-Machine-Applesoft, and allows the use of all three languages in a single program, on the Apple.

Rivers, Jerry, "Graphically Speaking," pgs. 5-10.

A tutorial on HIRES shapes with several demo listings.

#### 568. The Apple Shoppe, Vol 1, Iss. 3 (August 1979).

Clancy, Lee, "File Cabinet Fix," pg. 6.

File Cabinet (Apple User Library No. 3) search function can be extended to make it more useful.

Anon, "Graphics Workshop," pg. 7.

A tutorial on the famous Shapes program of Apple Hires.

Clark, Kim, "Water Cooled PETs," pgs. 9-11.

A drastic and probably fatal solution to overheated PET ROMs.

Wayne, Phil, "Language Lab," pgs. 11-17.

A tutorial on Pascal. In addition to the official "Apple Pascal" there is Programma's "Clarity Pascal (Tiny Pascal) and the soon to be released Programma "APscaLLE."

Williams, Ed., "Apple Speed," pgs. 19-20.

A utility to find the ratio of two different speed settings for Apple programs.

Welman, Chuck, "Binary Program Saver," pgs. 20-21.

This program determines the starting address and length of a binary program and then saves it.

Welman, Chuck, "THE DOS Dumper," pgs. 21-22.

This program lists the Apple II DOS Commands and their Memory locations.

Chavez, Franklin, "INDEX FILE by Programma," pgs. 22-23.

The reviewer gives this program high scores for quality and ease of use, but there are restrictions in format.

Crouch, Bill, "Making WHATSIT? Print," pgs. 24-27.

Modification of this popular Apple program for hard copy.

Crouch, Bill, "WHATSIT?"—48K Apple Version," pgs. 28-29.

A very good report on this expensive but still worthwhile program.

#### 569. Apple Peelings 1 No. 2 (September 1979)

Silverman, Ken, "September DOM," pg. 5.

A discussion of the programs on the Septgember DISK OF THE MONTH of the Apple Core.

Baldwin, G.R., "Don't Delay Until You've Read This," pg. 6.

The use of an Apple Monitor program called WAIT will give small delays of 1 to 162 milliseconds, Loops can be used to multiply this to longer delays.

Nareff, Max J., "Screenpauses—A Compilation," pg. 7.

A series of subroutines for conditional and unconditional delays for Integer or Applesoft Basic.

Burr, Richard, "Pascal Tips—Single Disk Users," pg. 7.

Special precautions if only one disk is used.

Nareff, Max J., "Avoiding Line Overruns and Blanks," pg. 8.

How to set up templates or formats for print statements.

Bernheim, Phil, "POKE 51,0—AUseful DOS Command," pg. 9.

An Applesoft/DOS fix.

#### 570. Kilobaud Microcomputing No. 34 (October 1979).

Lindsay, Len, "PET-pourri," pgs. 16-20.

Discussion of the Commodore Disk and the Computhink Disk, Disk software, Printer Update, Stop Key Disable, Merge Programs, etc.

Pepper, Clement S., "KIMCTR Measures Capacitance," pg. 64-66.

Measure capacitance 1pf to 999.999mfd.

Rogers, Kendal T., "Beefing Up PET," pg. 122.

You can have machine language and BASIC too in your PET. The machine language is up to 500 times faster.

Miles, Kenneth, "Apple's Documentation Strikes Again," pgs. 132-133.

The Apple Programmer's AID ROM comes with an excellent 96 page manual.

Klosson, Ken, "Pig Latin," pgs. 162-163.

Pig Latin for the OSI Computers using OSI 6502 Microsoft 8K Basic.

**571. Interface Age 4, No. 10 (October 1979)**

Inman, Don. "Apples, Computers and Teachers," pgs. 68-72.  
A workshop for teachers using strings to introduce BASIC statements and programming techniques.

**572. Southeastern Software Newsletter, Iss. 12 (September 1979).**

Carpenter, Chuck. "Indexing Fundamentals: Part I," pg. 2.  
A tutorial on absolute addressing, to be followed by another article on indirect addressing, and symbolic addressing.

Burnett, Carol. "LO-RES Graphics Program," pg. 4-5.  
Graphics with sound.

Anon. "Formatting \$ and Cents," pg. 5.  
A useful utility.

Anon. "Gas and Mileage Chart," pg. 6-7.  
Uses variables of miles per gallon, price per gallon, mileage and cost.

**573. Recreational Computing 8, No 2 (Sept/Oct 1979)**

Wells, Arthur, J. "An Apple PILOT Interpreter," pg. 24-27.  
How to write and use programs written in PILOT using a language interpreter program on your Apple II.

Saal, Harry. "SPOT," pg. 54-55.  
New games for the PET, etc.

Day, Jim. "Graphic Triples for Apple II," pg. 56.  
Program generates and displays Pythagorean triples.

**574. Stems from the Apple 2, Iss. 9. (Sept. 1979)**

Hoggatt, Ken. "Ken's Korner," pg. 2.  
Quick test to see which DOS (3.1 or 3.2) you have on disk.  
Misc. other hints and kinks.

Anon. "Faster than a Speeding Byte," pg. 4.  
All about the speed of microprocessors. The OSI Challenger (6502) is the only known production micro on the market to run faster than an Apple II.

Keyes, Patricia. "A String\$ Expression Compiler for Applesoft," pg. 8.

**575. Dr. Dobbs Journal 4, Iss. 9, No 39 (Oct. 1979)**

Diaz, Robert D. "Page List for the Apple," pg. 19-21.  
Program to permit listing one page at a time.

Ratliff, Gary. "Just Poking Around with my PET," pg. 22-23.  
Method of dumping memory to the screen and how to view the PET Basic Interpreter.

Wheeler, Steve. "Quick and Dirty Routines for the Sweet-16," pg. 24-25.  
A modification to the cassette version of the S-C Assembler II which gives it the capability to recognize and correctly assemble SWEET-16 mnemonics.

Morganstein, David. "David and Goliath," pg. 30-31.  
How to set up the OSI 430 Board RS232 interface to hook up a modem and phone lines.

Tan, B.T.G. "Common Instructions of the 6800 and 6502," pg 38-39.  
A tutorial comparing the instruction sets of two microprocessors.

**576. ABACUS II Newsletter, Iss. 9/10 (Sept/Oct 1979)**

Luebbert, Prof. William F. "What's Where in the Apple," pg. 1-8.  
A very comprehensive memory map (reprinted from MICRO).

Anon. "Real Handy Data," pg. 9-11.  
A series of Routines for the Apple, Tables of Apple Data, ASCII chart, Monitor Cross reference tables, Applesoft and Integer Token charts, Applesoft Interpreter Set, Apple DOS symbol table listing, Zero page usage, Lists of Computer Clubs, Apple User Groups, etc.

**577. Byte 4, No 10 (Oct. 1979)**

Garber, Joseph P. "Computer Generated Maps," pg. 18.  
A Hires Apple program for a map of the U.S.

**578. The Seed 1, Iss. 1 (June 1979)**

Willmore, Richard. "Recursive Primer," pg. 5-9.  
A tutorial on block-structured languages and their most powerful feature, recursion, which allows a program to create new copies of itself as the problem demands.

Knaster, Scott. "Controlling Control-C," pg. 9.  
An Applesoft program for use in turn-key systems which disables the Control C function of the Apple.

Anon. "Illegal Line Numbers," pg. 10.  
How to use illegal line numbers in a program, for the Apple. Works only on Cassettes. For DOS use 9600 instead of BFFF.

Anon. "Nifty Self Run," pg. 11.  
How to make any Applesoft program self-starting as it is loading.

Anon. "Apple Pi Library," pg. 12-15.  
A list of 472 programs for the Apple.

Nelsen, Rodney. "String Sorter," pg. 15.  
This program alphabetizes your strings on the Apple.

**579. The Seed 1, No 2 (July 1979)**

Taylor, T.N. "Apple Groups Publications," pg. 5.  
A list of Apple User Group Publications.

Willmore, Richard. "Reclusive Primer," pg. 5-7.  
A tutorial on block-structured languages.

Willmore, Richard. "Tools for Exploring a Frontier," pg. 8-12.  
All about compilers, XPL, PASCAL, Assemblers, File systems, Apple DOS, Floppy File Systems, etc.

Taylor, Terry, "Apple Pi Library," pgs. 13-20.  
863 Programs are listed, for the Apple.

Anon, "Apple Pascal," pgs. 3-6.  
A well written description of what to do when you get your Pascal package.

Taylor, Terry, "Apple Pi Library," pgs. 7-9.  
Some 400 new programs are listed bringing the total to over 1400.

Brown, Donald, "The \$7.00 Two-Apple Hookup," pgs. 9-10.  
All about the SART Routines that permit extremely cheap communications between two Apples.

Anon, "Information Processing: Surviving a Microcomputer Shift," pgs. 12-13.  
Reprinted from Business Week. A discussion with Computer marketing experts. How the Apple and TRS-80 have changed the small computer picture.

**580. Compute, Iss. 7 (Fall 1979)**

Hulon, Belinda and Hulon, Rick, "Sorting Sorts: A Programming Notebook," pg. 7.  
Several Sort methods are evaluated including Selection Sort, Bubble Sort, and Shell Sort. In a later article Machine Language sorts will be discussed.

Lindsay, Len, "Three Word Processors," pgs. 13-20.  
An overview of three word processors for the PET.

Byrd, J.S., "Microcomputers for Nuclear Instrumentation," pgs. 24-26.  
Describes the use of PET microcomputers in handling several applications at the Savannah River Laboratory.

Herman, Harvey, B., "Tokens Aren't Just for Subways," pgs. 29-30.  
A convenient method to list Microsoft Basic Tokens for the PET.



# JOIN RAYGAMCO NOW!



Become a member of  
**RAYGAMCO**  
Computer  
Discount Club.

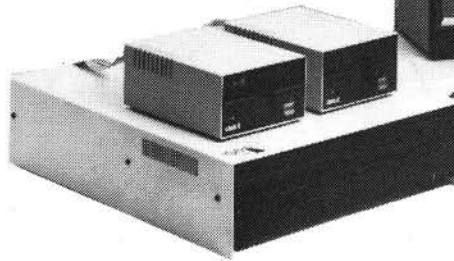

**SAVE  
20%  
AND MORE!**

**BIG SAVINGS ON EVERY ITEM!**



By being a RAYGAMCO Member you receive substantial discounts on every item you purchase, including all hardware, software, accessories, even books and paper! You will also receive a monthly newsletter with all the latest available for your particular computer system, and much, much more — exclusive to RAYGAMCO Members only!

All the famous brand names, including:

|                |             |           |                   |
|----------------|-------------|-----------|-------------------|
| APPLE          | Alpha Micro | Soroc     | Lear Siegler      |
| ATARI          | Alpha Pro   | Hazeltine | Shugart           |
| EXIDY/Sorcerer | Cromemco    | Sektor    | Texas Instruments |
| Kim/Commodore  | Xerox       | PET       |                   |

**SAVE 20% AND MORE!**

**Here's how to join.**

Fill out the information, and mail. That's all there is to it. Nothing to buy. I want to be a RAYGAMCO Computer Discount Club Member. Please send my RAYGAMCO Membership card to:

Name \_\_\_\_\_

Address \_\_\_\_\_

City \_\_\_\_\_ State \_\_\_\_\_ Zip \_\_\_\_\_

Computer (Brand Name) \_\_\_\_\_

I would like information on (please specify system, part, accessory, book, program, etc.)

WE HONOR VISA, MASTERCHARGE, BANKAMERICARD.

TOLL FREE, EXCEPT CA

Store Hours: Sat 10-6, Sun 12-4, Tu-Fri 11-8

800-854-6455

**RAYGAM, INC.**

6791 WESTMINSTER AVENUE WESTMINSTER, CA 92683

TELEX 182274

(714) 891-2587





**PET-AIM  
KIM-SYM**

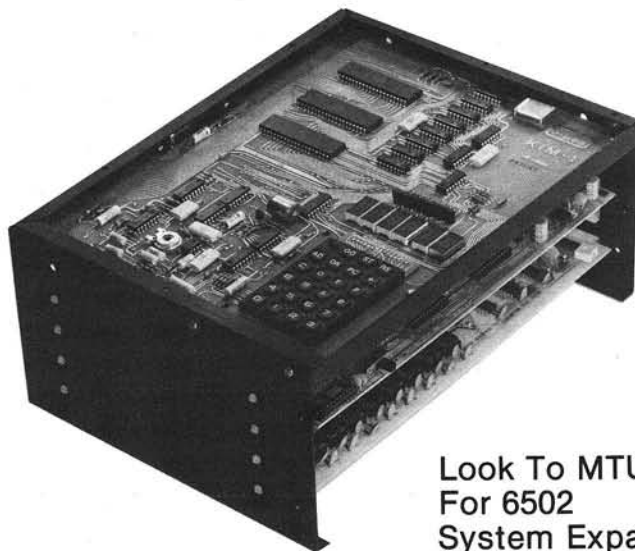

Look To MTU  
For 6502  
System Expansion



**Micro Technology Unlimited**  
P.O. Box 4596, 841 Galaxy Way  
Manchester, N.H. 03108  
603-627-1464

Call Or Write For Our Full Line Catalog

NOW PRESENTING...

# Software for Apple® II

for your Entertainment · Business · Education

## Star Attractions:

+WRITE-ON! Professional Word Processing lets you edit, move, delete, find, change and repeat any body of text, merge and save on disk. Does right-justified margins, centering, page numbering. You can enter name & address onto form letters when printing. Edit and merge any text disk file—even files not created by WRITE-ON—and spool text to disk for letter printing or editing. Chain up to 100 files in a single printer run. Needs Applesoft and 32K.  
**On Disk with operating manual** ..... \$99.50

Filemaster 2 programs: FORMAT & RETRIEVAL comprise a powerful data file manager. Great for everything from phone lists to legal abstracts. Design your own data structures. Up to 500 characters per record. Up to 15 searchable fields in any combination. Needs 32K. **On Disk** ..... \$34.95

+Space (Edu-Ware) Six programs form a unique epic game series. Multi-faceted simulation of life in interstellar society. You and opponents must make life & death decisions. Keeps track of your progress from one game to next. Needs 48K and Applesoft ROM. **Disk** ..... \$29.95

Pot O'Gold I or our All New Pot O' Gold II. A collection of 49 programs for 16K Apple. Everything from Logic to action games. Only a buck a game. Specify I or II. Price each: **Tape** ..... \$49     **Disk** ..... \$54

+Adventure This original, full-function game is the same as the one developed for large mainframes. Fight off pirates and vicious dwarfs. 700 travel options, 140 locations, 64 objects. Needs Applesoft ROM & 48K. **Disk** ..... \$29.95

32K Disk Inventory Use stock numbers, description, vendor, record of purchase and sales date, amount on hand, cost & sell price, total value. Holds up to 300 items.  
**Disk** ..... \$40  
+With Bill of Materials: **Disk** ..... \$50

32K Data Base Cross file for phone lists, bibliographies, recipes. Run up to 9 lines of 40 columns each. Search by item anywhere. **Disk** ..... \$20

24K Hi-Res Life Simulation Conway's equations on 296x180 screen. A mathematical simulation to demo population growth with birth, death and survival as factors.  
**Tape** ..... \$10

16K Rainbow's Casino 9 gambling games: Roulette, Blackjack, Craps, Horserace, Yahtzee, Keno, Slot Machine, Poker, and Acey-Ducey Needs 16K.  
**Tape** ..... \$29.95     **Disk** ..... \$34.95

**Don't see what you've been looking for, here? Then write for our FREE SOFTWARE CATALOG. We're saving one just for you!**

To order, add \$2 (U.S.); \$5 (foreign) for shipping. California residents add 6% sales tax. Sorry, we cannot ship to P.O. Boxes. VISA/MASTERCHARGE and BANKAMERICARD Welcomed!

16K Space War: You in your space capsule battle against the computer's saucer . . . in hi-res graphics. **Tape** ..... \$12

16K Memory Verify Diagnostic routine to check range of memory. Indicates faulty addresses, data in memory cell, and faulty data. **Tape** ..... \$5

16K Appleodion Music synthesis composes original Irish jigs. Enter your own music and save on tape or disk. Includes 3 Bach fugues. **Tape** ..... \$10

+48K Edu-Pack (Edu-Ware) This package combines COMPU-READ—five speed reading programs; three PERCEPTION games where random shapes and sizes must be matched; and STATISTICS for computing Mean, Variance, Standard Deviation, and much more! Needs Applesoft ROM. **Disk** ..... \$39.95

+32K Sargon II (Hayden) Here's the program that came in third against the big machines (mainframes and maxis) at the 9th North American Computer Chess Championship and played first in the European Microcomputer Chess Championships! Has seven levels of play with Levels 0 - 3 playing in tournament time. Need a challenge? This is it!! **Tape** ..... \$29.95     **Disk** ..... \$34.95

16K Hi-Res Baseball (Programma International) This animated simulation of a major league baseball game is for two players. The scoreboard is in the lower left of screen with the "throw pointer" for directing a throw in the lower right corner. Written entirely in machine language, the action is quick and smooth, making it the finest simulation of its kind. **Tape** ..... \$15.95

### Other Special Items For Your Apple II

VERSAWRITER This digitizer drawing board lets you create any picture in full color, with high resolution graphics. Ideal for mass graphics. Powerful software package included on disk. You can trace, edit, save and recall what you draw. It's a simple-to-use system for students, artists, engineers and graphic programmers. 8 1/2"x11" working area. Applesoft ROM and 32K required. **\$199.00** (Add \$5 [U.S.] and \$10 [foreign] for shipping)

Apple Monitor Peeled Everything you wanted to know about the Apple Monitor but couldn't figure out. All the PEEKS, POKES, and CALLS explained in an easy-to-understand form, written in plain English. **Only** ..... \$9.95

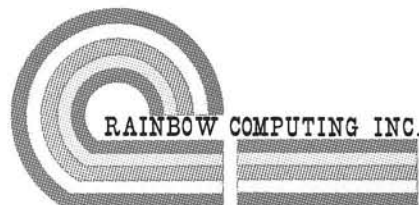

Golden Plaza Shopping Center, Dept. 1A  
9719 Reseda Blvd., Northridge, CA 91324  
Telephone: (213) 349-5560

+ = Apple Plus compatible



# NEW APPLE II SOFTWARE

PROGRAMMA Software Program Products

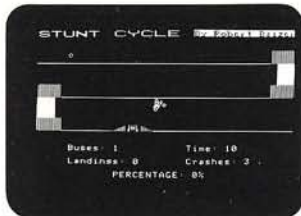

STUNT CYCLE \$15.95



BLITZKRIEG \$15.95

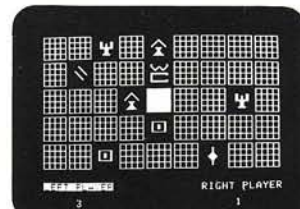

FRUSTRATION \$ 9.95



PERPETUAL CALENDAR \$ 9.95

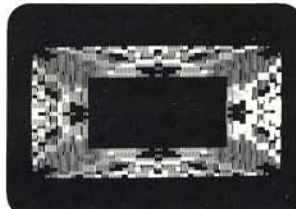

LORES HYPERPAK \$ 6.95

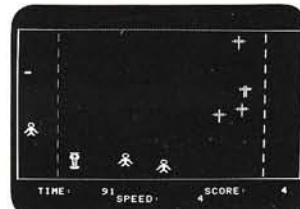

DEATH RACE \$15.95

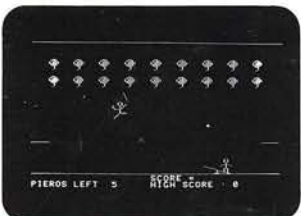

CLOWNS & BALLOONS \$15.95

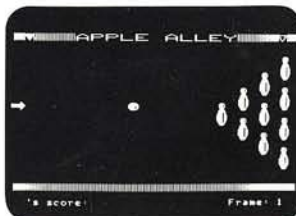

APPLE ALLEY \$ 6.95

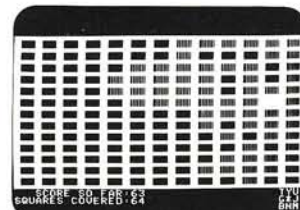

MOUSE HOLE \$ 6.95

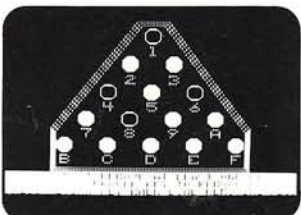

PEG JUMP \$ 9.95



I-CHING \$15.95



WORDWACKEY \$ 6.95

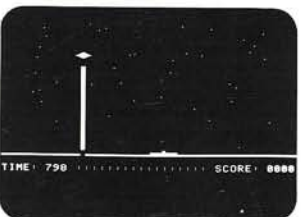

ALIEN INVASION \$ 9.95



GUIDED MISSILE \$15.95



APPLE INVADER \$15.95

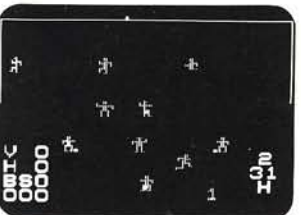

BASEBALL \$15.95

All orders must include 3% postage and handling with a minimum of \$1.00. California residents include 6% sales tax.  
VISA MASTERCHARGE

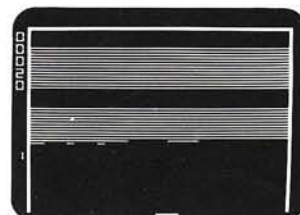

BREAKTHRU \$ 9.95

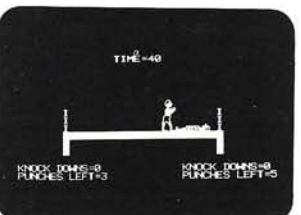

BOXING \$ 9.95

**PROGRAMMA INTERNATIONAL, Inc.**  
3400 Wilshire Blvd.  
Los Angeles, CA 90010  
(213) 384-0579  
384-1116  
384-1117

Dealer Inquiries Invited

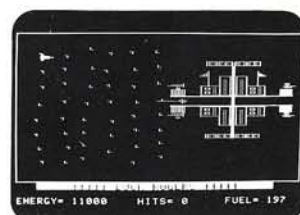

STAR VOYAGER \$15.95