

# MICRO

P33  
ELECTROSCOP™

*Advancing Computer Knowledge*



## Math/Applications/Simulations

VIC Hi-Res Graphics

APPLE Pascal Math Editor

68000 Instructions



# ARTSCI HAS NEW PRODUCTS, NEW PACKAGING, NEW OFFICES,



**Magic Window II** is a powerful spreadsheet program for the Apple II. It features a 70-column upper and lower case display, 160 character line length, multiple copy/print feature, and DOS housekeeping commands within the program. **\$149.95**

**Magic Calc** is a powerful spreadsheet program for the Apple II. It features a 70-column upper and lower case display, 160 character line length, multiple copy/print feature, and DOS housekeeping commands within the program. **\$149.95**

**Magic Calc II** is a powerful spreadsheet program for the Apple II. It features a 70-column upper and lower case display, 160 character line length, multiple copy/print feature, and DOS housekeeping commands within the program. **\$149.95**

**ARTSCI — a new look, with the same old reliability at an affordable price.**

5547 satsuma avenue • north hollywood, california 91601 • 213/985-2922

VisiCalc is a registered trademark of VisiCorp. MAGICALC is a trademark of Artsci, Inc.

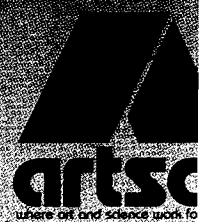



# 2MHZ 6809 SYSTEMS

*GIMIX offers you a variety to choose from!*

## 38 MB WINCHESTER SYSTEM ..... \$17,498.99

### HARDWARE FEATURES:

- ★ 2MHz 6809 CPU
- ★ 512KB Static RAM
- ★ 8 RS232C Serial Ports
- ★ 2 Parallel Ports
- ★ DMA Double Density Floppy Disk Controller
- ★ Dual 8" DSDD Floppy Disk System
- ★ Dual Winchester Subsystem with Two 19 MB 5¼" Winchester Drives

### SOFTWARE FEATURES:

- ★ OS-9 LEVEL TWO Multi-User Operating System
- ★ OS-9 Debugger
- ★ OS-9 Text Editor
- ★ OS-9 Assembler

## 19 MB WINCHESTER SYSTEM ..... \$8998.09

### HARDWARE FEATURES:

- ★ 128K Static Ram
- ★ 2MHz 6809 CPU
- ★ 19 MB 5¼" Winchester DMA Subsystem
- ★ 4 RS232C Serial Ports
- ★ 1 MB 5¼" Floppy Disk Drive
- ★ DMA Double Density Floppy Disk Controller

### SOFTWARE FEATURES:

- ★ OS-9 LEVEL TWO Multi-User Operating System
- ★ OS-9 Text Editor
- ★ OS-9 Debugger
- ★ OS-9 Assembler

## 128KB MULTI-USER SYSTEM ..... \$6997.39

### HARDWARE FEATURES:

- ★ 2MHz 6809 CPU
- ★ DMA Double Density Floppy Disk Controller
- ★ 128KB Static Ram
- ★ 2 RS232C Serial Ports
- ★ Dual 8" DSDD Floppy Disk System

**SOFTWARE FEATURES:** Your choice of either UniFLEX or OS-9 LEVEL TWO. Both are Unix-like Multi-User/Multi-Tasking Operating Systems.

## 56KB FLEX / OS-9 "SWITCHING" SYSTEM ..... \$4148.49

### HARDWARE FEATURES:

- ★ 2MHz 6809 CPU
- ★ 56K Static Ram
- ★ 2 RS232C Serial Ports
- ★ DMA Double Density Floppy Disk Controller
- ★ 2 Built-in 5¼" 40tr DSDD Disk Drives (80 Track DSDD Drive Option . . . add \$400.00)

### SOFTWARE FEATURES:

- ★ GMXBUG monitor — FLEX Disk Operating System
- ★ OS-9 LEVEL ONE Multi-tasking operating system for up to 56K of memory

## WINCHESTER SUBSYSTEMS

Winchester packages are available for upgrading current GIMIX 6809 systems equipped with DMA controllers, at least one floppy disk drive, and running FLEX, OS-9 LEVEL ONE or OS-9 LEVEL TWO. The packages include one or two 19MB (unformatted) Winchester drives, DMA Hard Disk Interface, and the appropriate software drivers. The Interface can handle two 5¼" Winchester Drives, providing Automatic Data Error Detection and Correction; up to 22 bit burst error detection and 11 bit burst error correction.

Dual drives can be used together to provide over 30 MBytes of on line storage -- or use one for back-up of the other. (More convenient and reliable than tape backup systems.)

#90 includes one 19MB Drive, Interface, and Software ..... \$4288.90

#91 includes two 19MB Drives, Interface, and Software ..... \$6688.91

**Contact GIMIX for systems customized to your needs or for more information.**

50 HZ Export Versions Available

GIMIX Inc. reserves the right to change pricing and product specifications at any time without further notice.

1337 WEST 37th PLACE  
CHICAGO, ILLINOIS 60609

(312) 927-5510

TWX 910-221-4055

# GIMIX inc.

1982 GIMIX Inc.

GIMIX® and GHOST® are registered trademarks of GIMIX Inc.  
FLEX and UniFLEX are trademarks of Technical Systems Consultants Inc.  
OS-9 is a trademark of Microware Inc.



# Skyles Electric Works Presents

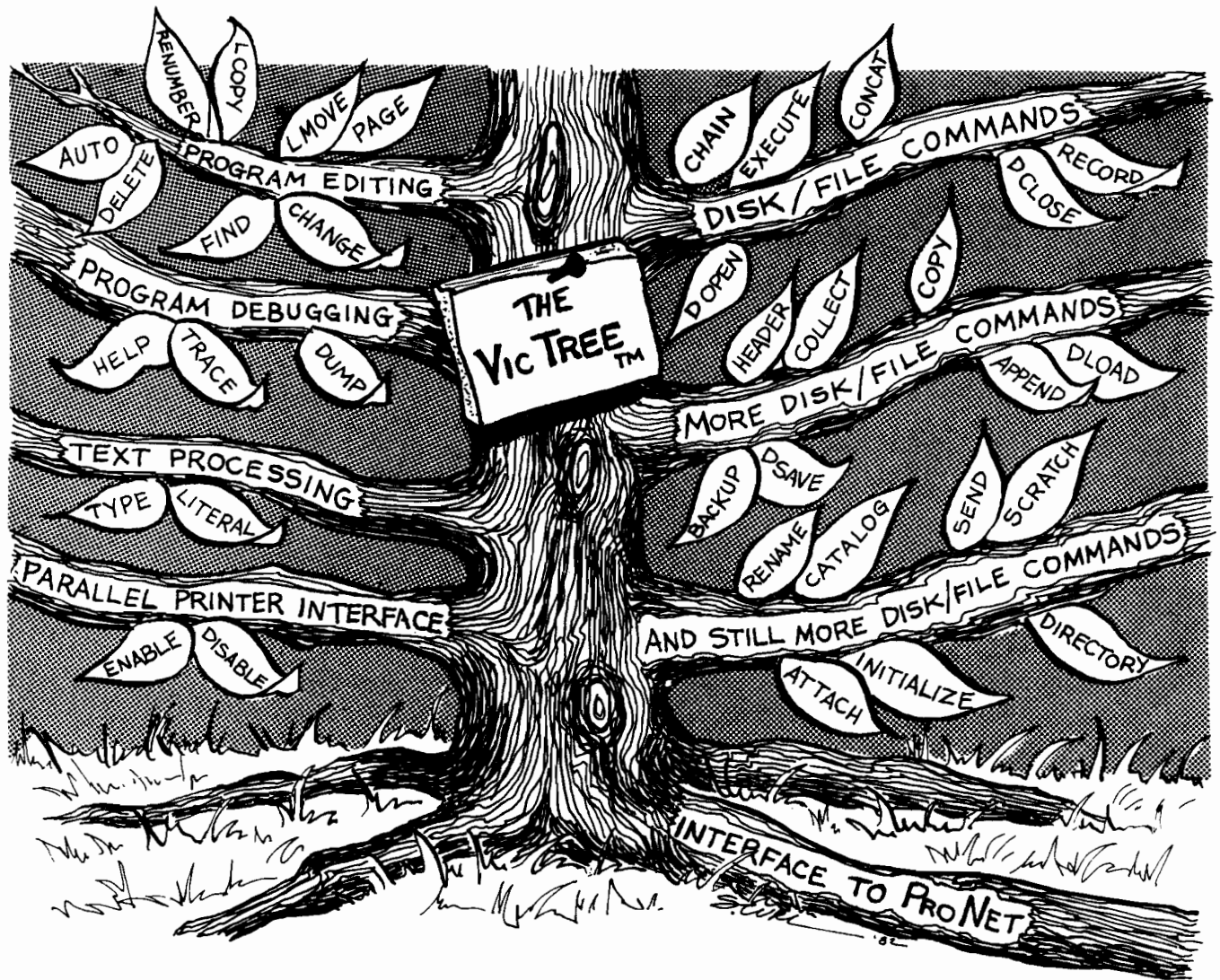

## The VicTree™

...Leaves your new Vic (or CBM 64) with 35 additional commands.

...Branches out to most BASIC 4.0 programs.

...Roots into most printers.

New from Skyles: the VicTree, a coordinated hardware and software package that allows your Vic to branch out in unbelievable directions and makes it easier than ever to do BASIC programming, debugging and to access your disk. And the new VicTree provides routines to interface the Vic to the powerful ProNet local network. 8kb of ROM — 4kb for the BASIC commands, 4kb for disk commands and interfacing to ProNet — plus 4kb of RAM for miscellaneous storage. Perfect not only for the new Vic but also for the Commodore 64. Unbelievably simple to use and to install, the VicTree gives you all the additional BASIC 4.0 commands to allow most BASIC 4.0 programs to work on your new Vic or CBM 64.

Now only \$89.95...or \$99.95 complete with Centronics standard printer cable. (Cable alone \$19.95.) Available now from your local dealer or order through your Visa or MasterCard toll free: (800) 227-9998 (California, Canada, Alaska, Hawaii: (415) 965-1735) or send check or money order directly to:



**Skyles Electric Works**

231E South Whisman Road  
Mountain View, CA 94041  
(415) 965-1735

Due to the nature of our features on simulations, applications, and math in this issue, many articles here will interest users of a wide range of systems. Even the programs written for a particular machine usually can be adapted to another. Apple, Commodore, Atari, VIC, OSI, and TSC XBASIC users will all find material of interest.

### Simulations and Applications

Simulations save time and money in business, education, and research. For instance, a flight simulator program, available commercially for the Apple and other microcomputers, allows the user to control a plane through keyboard commands. Bigger computers, coupled with replicas of actual airplane control panels, allow student pilots to log a considerable amount of flying time without renting a plane or jeopardizing lives. Simulator programs are used in scientific research for testing mathematical models (e.g., of a predator-prey relationship) and in industry for determining how products will stand up to various kinds of stress.

"Discrete Event Simulation" by Anita and Bill Walker (p. 21) discusses techniques that can be applied to simulation programming with a microcomputer. The Walkers use as an example a program, written for the Apple II, that simulates the flow of customers in a bank line. "Rocket I," a program by David Eagle (p. 31), predicts the performance of a model rocket engine, given its specifications. "Sun and Moon" by Svend Ostrup (p. 35) is a high-resolution simulation of the apparent orbits of the sun and moon with respect to the earth. Phases of the moon are simulated, along with lunar and solar eclipses. In this month's editorial, Editor-in-Chief Bob Tripp describes his experience with simulations.

Accompanying our simulation feature are applications — a more familiar use of the computer. The computer's use in a non-computer activity may be as little as performing calculations or as much as actually operating a scientific experiment.

The second part of Jim Strasma's series on package programming using the CBM disk operating system ("It's All Relative, Part 2," page 52) will be of particular interest to the business user. Engineering applications are included in Andrew Cornwall's "Microcomputer Design of Transistor Amplifiers" (p. 59), and "Microcomputers in a College Teaching Laboratory" by Thor Olsen, et. al. (p. 38). In "Measurement of a 35mm Focal Plane Shutter" (p. 45), Mike Dougherty describes simple hardware and Atari soft-

ware to test the accuracy and reliability of the shutter found in most single-lens reflex cameras. "Doing Time" by Jim Schreier (p. 28) shows how to do calculations involving time in TSC BASIC on 6809-based computers.

### Mathematics Articles

Timothy Stryker's "Signed Binary Multiplication" (p. 76), Charles Muhleman's "Numerical Rounding" (p. 89), and P.P. Ong's "Methods to Evaluate Complex Roots" (p. 71), will be of interest to everyone who uses the computer to solve mathematical problems. "Apple Math Editor" by Robert Walker (p. 78) is a sophisticated program written in Apple Pascal that provides convenient display, editing, and printing of mathematical formulas. "Using Long Integers" by David Oshel (p. 86) describes the implementation of a bullet-proof string conversion for Pascal 1.1 long integers with implied decimal points.

### Color Computer Data Sheet

Color Computer programmers will want to keep the data sheet (p. 109) handy. Here, on one easy-to-read sheet, is essential information on character codes, memory locations, and hardware interfacing.

### Columns

System-specific information rounds out this month's magazine. Paul Swanson's "From Here to Atari" (p. 19) discusses reference books every Atari programmer will want to keep on hand. Loren Wright's "PET Vet" (p. 69) offers more observations on the new Commodore 64 and some how-to information on transferring programs from one Commodore machine to another. "CoCo Bits" by John Steiner (p. 92) provides news relating to the Color Computer, lists several programming books, and discusses the set-up for a high-resolution graphics display. Tim Osborn, in "Apple Slices" (p. 64), presents a program, ALTERNATE INDEX, that expands the capabilities of BINARY-SEARCH, a program discussed in his previous column.

# INDUSTRIAL CONTROL MICROCOMPUTERS

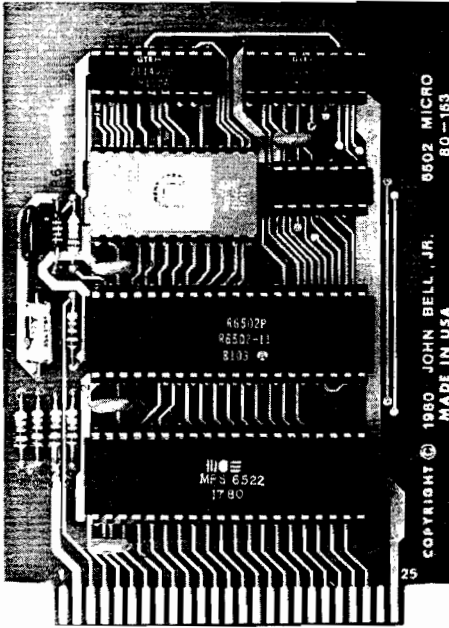

## 6502 AND Z80 MICROCOMPUTERS ARE DEDICATED COMPUTERS DESIGNED FOR CONTROL FUNCTIONS.

### THESE BOARDS FEATURE:

- 4096 BYTES EPROM
- 1024 BYTES RAM
- ALL BOARDS INCLUDE COMPLETE DOCUMENTATION
- 50 PIN CONNECTOR INCLUDED
- EPROM AVAILABLE SEPARATELY

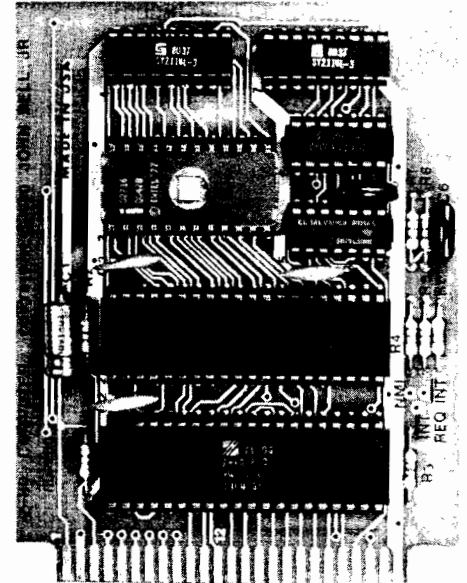

### JOHN BELL ENGINEERING'S 6502 MICROCOMPUTER FEATURES:

- 1024 BYTES RAM
- 4096 BYTES EPROM
- USES ONE 6522 VIA (DOC. INCL.)
- 2 8 BIT BIDIRECTIONAL I/O PORTS
- 2 16 BIT PROGRAMMABLE TIMER/COUNTERS
- SERIAL DATA PORT
- LATCHED I/O WITH HANDSHAKING LOGIC
- TTL AND CMOS COMPATIBLE

**80-153A** LIST 100-499  
**EPROM NOT INCLUDED \$110.95 \$66.57**

### JOHN BELL ENGINEERING'S NEW Z80 MICROCOMPUTER FEATURES:

- Z80 CPU-SOFTWARE COMPATIBLE WITH Z80, 8080 AND 8085 MICROPROCESSORS
- 4096 BYTES EPROM
- 1024 BYTES RAM
- SINGLE 5V POWER SUPPLY AT 300MA
- CLOCK FREQUENCY IS 2MHZ, RC CONTROLLED
- Z80 PIO (DOC. INCL.)
- 2 8-BIT BIDIRECTIONAL I/O PORTS
- LATCHED I/O WITH HANDSHAKING LOGIC
- TTL AND CMOS COMPATIBLE

**80-280A** LIST 100-499  
**EPROM NOT INCLUDED \$129.95 \$77.97**

### USE YOUR 6502 OR Z80 MICROCOMPUTER TO CONTROL EVERYTHING!

- YOUR HOME SECURITY SYSTEM
- HEAT CONTROL
- LIGHT CONTROL
- SOLAR HEATING AND POWER SYSTEMS
- AUTOMATIC CONTROL OF TAPE RECORDERS
- TRAFFIC LIGHT CONTROL
- IRRIGATION SYSTEMS
- AUTOMATIC CONTROL OF VIDEO RECORDERS
- ROBOT CONTROL
- AUTOMATIC DIALER
- AUTOMATED SLIDE SHOW CONTROL
- COMMUNICATION SYSTEMS FOR THE DISABLED
- THE WORLD



## JOHN BELL ENGINEERING, INC.

ALL PRODUCTS ARE AVAILABLE FROM JOHN BELL ENGINEERING, INC. • 1014 CENTER ST., SAN CARLOS, CA 94070  
 ADD SALES TAX IN CALIFORNIA • ADD 5% SHIPPING & HANDLING 3% FOR ORDERS OVER \$100



SEND \$1.00 FOR CATALOG

**(415) 592-8411**

WILL CALL HOURS: 9am-4pm

10% OUTSIDE U.S.A.  
 ADD \$1.50 FOR C.O.D.



#300

# MICRO™

Advancing Computer Knowledge

## STAFF

President/Editor-in-Chief  
ROBERT M. TRIPP

Publisher  
MARY GRACE SMITH

Editorial Staff  
PHIL DALEY — Technical editor  
JOHN HEDDERMAN — Jr. programmer  
MARJORIE MORSE — Editor  
JOAN WITHAM — Editorial assistant  
LOREN WRIGHT — Technical editor

Graphics Department  
HELEN BETZ — Director  
PAULA M. KRAMER — Production mgr.  
EMMALYN H. BENTLEY — Typesetter

Sales and Marketing  
CATHI BLAND — Advertising manager  
CAROL A. STARK — Circulation mgr.  
LINDA HENS DILL — Dealer sales  
MAUREEN DUBE — Promotion

Accounting Department  
DONNA M. TRIPP — Comptroller  
KAY COLLINS — Bookkeeper  
EILEEN ENOS — Bookkeeper

Contributing Editors  
CORNELIS BONGERS  
DAVE MALMBERG  
JOHN STEINER  
JIM STRASMA  
PAUL SWANSON  
RICHARD VILE

Subscription/Dealer inquiries  
(617) 256-5515

## DEPARTMENTS

- 3 January Highlights
- 7 Editorial
- 9 Updates/Microbes
- 19 From Here to ATARI
- 64 APPLE Slices
- 69 PET Vet
- 89 Short Subjects
- 92 CoCo Bits
- 93 New Publications
- 94 Reviews in Brief
- 99 Software Catalog
- 104 Hardware Catalog
- 107 6809 Bibliography
- 109 Data Sheet
- 111 Advertiser's Index
- 112 Next Month in MICRO

## SIMULATIONS/APPLICATIONS

- 21 Discrete Event Simulation in Pascal** ..... Anita and Bill Walker  
Simulate real-world situations
- 28 Doing Time on the 6809** ..... Jim Schreier  
Add time in BASIC
- 31 Model Rocket Simulation in BASIC** ..... David Eagle  
Determine the altitude performance of single-stage model rockets
- 35 Sun and Moon on the APPLE** ..... Svend Ostrup  
Hi-res graphics simulation: the orbits of the sun and moon
- 38 Microcomputers in a College Teaching Laboratory, Part 3** ..... Thor Olsen, Howard Saltsburg, and Richard Heist  
Process Control and the microcomputer
- 45 Measurement of a 35mm Focal Plane Shutter** ..... Mike Dougherty  
Use inexpensive hardware to measure the accuracy of your camera
- 52 It's All Relative — Using CBM's Relative Records, Part 2** ..... James Strasma  
Learn how to set up relative files and records
- 59 Microcomputer Design of Transistor Amplifiers** ..... Andy Cornwall  
This program makes it easy to design practical, small signal amplifier stages

## TUTORIALS

- 11 VIC Hi-Res Graphics Explained** ..... Nicholas J. Vrtis  
Produce 160- by 176-dot graphics
- 15 68000 Shift, Rotate, and Bit Manipulation Instructions** ..... Joe Hootman  
More detailed coverage of the 68000

## MATH

- 71 Extending Newton-Raphson's Method to Evaluate Complex Roots** ..... P.P. Ong  
Compute the complex roots of a polynomial equation
- 76 Signed Binary Multiplication is Unsigned** ..... Timothy Stryker  
Put this mathematical curiosity to work
- 78 APPLE Math Editor** ..... Robert D. Walker  
Easy construction, editing, and printing of mathematical formulas
- 86 Using Long Integers for BCD Numbers in Pascal** ..... David C. Oshel  
Bullet-proof string conversion



Emulates these terminals exactly.

IBM 3101  
DEC VT100, VT52  
Data General D200  
ADDS Regent 20, 25, 40  
Hazeltine 1400, 1410, 1500  
Lear Siegler ADM-3A, ADM-5  
TeleVideo 910  
Teletype Model 33 KSR

Apple is a trademark of  
Apple Computer, Inc.

New File Transfer Language

# SOFTERM<sup>®</sup>

High-speed  
CRT Look-alike Software  
for Your Apple<sup>®</sup>

BREAK  
CATALOG  
CHAIN  
CONFIGURE  
CONNECT  
CONVERSE  
DIAL  
END  
HANGUP  
LOG  
MONITOR  
NOLOG  
ONERR  
PAUSE  
PROMPT  
RECEIVE  
REMARK  
RETRIES  
SEND  
SPECIAL  
SPEED  
TIMEOUT  
XMIT:WAIT

Supports these  
interface boards.

Apple Communications Card  
Apple Parallel Printer  
Apple Serial Interface  
Apple Super Serial Card  
Bit 3 Dual-Comm Plus™  
CCS 7710, 7720, 7728  
Hayes Micromodem II™  
Hayes Smartmodem™ 300, & 1200  
Intra Computer PS10  
Mountain Computer CPS Card™  
Novation Apple-Cat II™ 300 & 1200  
Orange Micro Grappler™  
Prometheus VERSAcad™  
SSM ASIO, APIO, AIO, AIO II™

Supports your 80-column hardware.

ALS Smarterm™  
Bit 3 Full-View 80™  
Computer Stop Omnivision™  
M&R Sup'RTerminal™  
STB Systems STB-80™  
Videx Videoterm™  
Vista Computer Vision 80™  
Wesper Micro Wizard 80™

## Your host computer won't know the difference!

Softerm provides an *exact* terminal emulation for a wide range of CRT terminals which interface to a variety of host computer systems. Special function keys, sophisticated editing features, even local printer capabilities of the terminals emulated by Softerm are fully supported. Softerm operates with even the most discriminating host computer applications including video editors. And at speeds up to 9600 baud using either a direct connection or any standard modem.

### Unmatched file transfer capability

Softerm offers file transfer methods flexible enough to match any host computer requirement. These include *character protocol* with user-definable terminator and acknowledge strings, block size, and character echo wait, and the intelligent *Softrans™* protocol which provides reliable error-free transmission and reception of data. The character protocol provides maximum flexibility for text file transfers. *Any* type file may be transferred using the *Softrans* protocol which provides automatic binary encoding and decoding, block checking with error recovery, and data compression to enhance line utilization. A FORTRAN 77 source program is supplied with Softerm which is easily adaptable to any host computer to allow communications with Softerm

using the Softrans protocol.

Softerm file transfer utilizes an easy to use *command language* which allows simple definition of even complex multiple-file transfers with handshaking. Twenty-three high-level commands include *DIAL, CATALOG, SEND, RECEIVE, ONERR, HANGUP, MONITOR* and others which may be executed in immediate command mode interactively or from a file transfer macro command file which has been previously entered and saved on disk.

### Built-in utilities

Softerm disk utilities allow DOS commands such as *CATALOG, INIT, RENAME, and DELETE* to be executed allowing convenient file maintenance. Local file transfers allow files to be displayed, printed, or even copied to another file without exiting the Softerm program. Numerous editing options such as tab expansion and space compression are provided to allow easy reformatting of data to accommodate the variations in data formats used by host computers. Softerm supports automatic dialing in both terminal and file transfer modes. Dial utilities allow a *phone book* of frequently used numbers to be defined which are accessed by a user-assigned name and specify

the serial interface parameters to be used.

### Online Update Service

The Softronics Online Update Service is provided as an additional support service at no additional cost to Softerm users. Its purpose is to allow fast turnaround of Softerm program fixes for user-reported problems using the *automatic patch facility* included in Softerm as well as a convenient distribution method for additional terminal emulations and I/O drivers which become available. *User correspondence* can be electronically mailed to Softronics, and *user-contributed* keyboard macros, file transfer macros, and host adaptations of the Softrans FORTRAN 77 program are available on-line.

### Most advanced communications software available

Just check Softerm's 300 page user manual. You simply can't buy a more sophisticated package or one that's easier to use. Available now for only \$150 from your local dealer or Softronics, Inc.

**SOFTRONICS**  
6626 Prince Edward, Memphis, TN 38119. 901-755-5006



## About the Cover

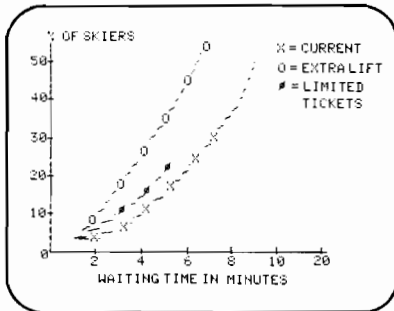

The skier on our cover this month flies gracefully down a snowy Waterville Valley slope. His face reflects the exhilaration every skier feels while out in the sun and crisp air.

See our editorial for a discussion on queuing — something many downhillers experience before they hit the slopes.

Cover photo by:

Joan Eaton  
Waterville Valley Photo  
Waterville Valley, NH

**MICRO** is published monthly by:  
MICRO INK, Chelmsford, MA 01824  
Second Class postage paid at:  
Chelmsford, MA 01824 and additional  
mailing offices  
USPS Publication Number: 483470  
ISSN: 0271-9002

Send subscriptions, change of address, USPS  
Form 3579, requests for back issues and all  
other fulfillment questions to

MICRO INK  
34 Chelmsford Street  
P.O. Box 6502  
Chelmsford, MA 01824  
or call  
617/256-5515  
Telex: 955329 TLX SRVC  
800-227-1617

Subscription Rates	Per Year
U.S.	\$24.00
	2 yr. / \$42.00
Foreign surface mail	\$27.00
Air mail:	
Europe	\$42.00
Mexico, Central America, Middle East, North Africa, Central Africa	\$48.00
South America, South Africa, Far East, Australasia, New Zealand	\$72.00

Copyright © 1982 by MICRO INK  
All Rights Reserved

# MICRO™

## Editorial

### A GASP, a Wheeze, and a 'Gotcha'

The typical MICRO reader owns a system and uses it primarily for serious work and program development. This issue focuses on ways to use your computer in real applications, mathematical problems, and in discrete event simulation. While the value and use of the real applications and the mathematical material should be obvious, the computer simulation will be a new topic for many readers.

"Discrete Event Simulation" (see the Walker article starting on page 21) is an exciting, broad area of computer application that often disguises itself as a rather dull, limited technique. This is due, I believe, to the examples presented: average waiting time in a bank queue, average waiting time in a doctor's office, and so forth. Don't let these particular examples mislead you. Computer simulation can be fun!

Years ago, I took a course in Discrete Computer Simulation. The basis of the course was a computer simulation package called "General Activity Simulation Program" (GASP). Written as a series of FORTRAN subroutines, this was configured to run on a PDP-10. The user would write a program that set up the operating environment parameters and called various support subroutines as required.

While many classmates simulated traffic lights and cafeterias as term projects, I chose to simulate the Waterville Valley Ski Area of New Hampshire. This month's cover symbolizes this study. Whenever I think of downhill skiing, two images come immediately to mind. First, there is the image of racing down the clean white slopes, passing through the picturesque trails, breathing the fresh air. Second, there is the image of the lift line, with the long wait, the dreary dirty snow underfoot, the cold of just standing and waiting. My simulation addressed methods of reducing the lift line wait by limiting the number of tickets sold each day, developing additional long trails, and adding another lift. Since the lift

manager in those days was my cousin, I was able to get real information about the length of the lift ride, average time down the slope, number of customers, and so forth.

My first 'real' simulation was of a microprocessor. We needed to know if the processor could successfully handle eight operators simultaneously typing on individual keyboards. Unfortunately, the PDP-10 was not available. I located a PDP-9 and converted 'GASP' from the PDP-10 to 'Wheeze' on the PDP-9. The conversion was not difficult, and I think it could be easily converted to run in BASIC on almost any of the current micros.

Converting the program wasn't a problem, but running it became a nightmare. A simulation of this nature, where the event is the keystroke of one of eight operators, will be necessarily slow. The actual event might average one occurrence every 10 milliseconds or so (eight operators typing at twelve characters per second each), while the simulation processing might take one to three seconds per event, creating a 100- to 300-fold time expansion. A simulation of five minutes of typing could take between 500 and 1500 minutes to run! Since the PDP-9 was not being used for anything else, that should not have been a problem - but it was.

Everytime the program was run, it would work for a while, but would crash before completion. I noticed that the crashes seemed to occur at about 11:30 AM and 3:30 PM. A little investigation revealed that the machinists in the shop on the floor above quit for lunch at 11:30 and quit for the day at 3:30. That was the 'Gotcha' - a power surge from the machines being turned off. The simulation program worked perfectly - but only at night.

The results of the keyboard simulation showed that not only could the microprocessor keep up with the eight operators, it would be idle almost 80 percent of the time!

There are many interesting events that may be simulated. With your dedicated equipment, you can do significant simulations.

*Robert M. Tripp*

Robert M. Tripp

President/Editor-in-Chief

**Now Available as a Boxed Set**

# MICRO on the Apple Series

We have taken the best Apple-specific programming aids, utilities, enhancements, games and more that have appeared in **MICRO**, The 6502/6809 Journal, and put them in three Wire-O-Bound volumes for easy use.

...and we've made it even **EASIER** by entering every program on one diskette!  
(included in the price)

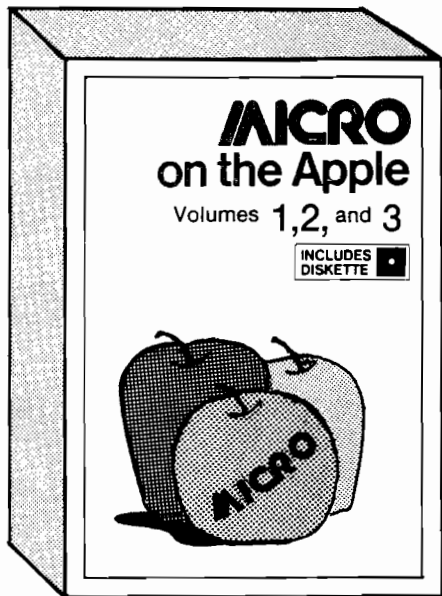

## Volume 1 Allows you to:

- Round and format numbers accurately
- Get lowercase letters and punctuation into Applesoft strings
- Play the hit game "Spelunker"

## Volume 2 Lets you:

- Speed up machine-language programming using five powerful machine-language aids
- Add additional editing and I/O features
- Play the intriguing game "GalactiCube"

## Volume 3 Gives you more:

- Machine-language aids
- I/O enhancements
- Graphics and games

*All three volumes, attractively boxed for only **\$59.95**  
(Including 110 programs on one diskette)*

**20% savings off individual purchase price**  
(If purchased separately — \$74.95)

**MICRO  
on the  
APPLE  
Series**

- Three-Volume Gift-Boxed Series **\$59.95** (plus \$5.00 s/h)  
 Vol. 1    Vol. 2    Vol. 3   **\$24.95 ea.** (plus \$2.00 s/h)  
 Check Enclosed    VISA    MasterCard  
Payable to MICRO (MA residents add 5% sales tax)

Card #

Expires

Name

Address

City

State/Prov  Zip

Country

M 1-82

**Order TODAY!**  
Mail to



34 Chelmsford Street  
P.O. Box 6502  
Chelmsford, MA 01824  
617/256-5515

Call Today — Toll Free  
**1-800-345-8112**  
(In PA 1-800-662-2444)

## Updates and Microbes

### Homespun Revision

John Beckett of Collegedale, TN, sent in this revision to "A Homespun 32K Color Computer" (53:91).

Do solder the chips together, rather than expecting hand-bent pins to make good contact. Model I users will be happy to comment in favor of *anything* to improve the communication between your CPU and memory.

It is best to put a ferrite bead around the wire connected to the 6883 chip, just before it reaches the 6883. Failing that, use a 33-ohm resistor. This is done in Tandy's 32K version, and is recommended by Motorola in their 6883 data sheet.

Later models of the PC board have a place on the PC board where you can

connect the lead from the extra "bunk" of chips. It would be best to connect to that place, so as to avoid soldering directly to the 6883.

### What's Where in the Apple Atlas Updates

The following subroutines have been relocated in the new (Autostart) ROMS:

Subroutine	Old Monitor Applesoft	New Autostart Applesoft
HGR2	F3D4	F3D8
HGR	F3DE	F3E2
HCLR	F3EE	F3F2
BKGND	F3F2	F3F4
HPOSN	F40D	F411
HPLOT	F453	F457
HLIN	F530	F53A

### Microbes

The following change should be made in the review of *Light-Pen in Reviews in Brief* (53:97).

Under the minuses, the first sentence should read "The programs require a machine-language routine..." rather than "The programs use a machine-language routine...."

*Let us know if you've updated an article or discovered a bug. Send a note to: Updates/Microbes, MICRO, P.O. Box 6502, Chelmsford, MA 01824.*

MICRO

## UPGRADE YOUR AIM-65\* INSTANTLY

\*A trademark of Rockwell Inc.

### To A 6809 Development System

With The

"MACH-9"

From

M M S Inc.

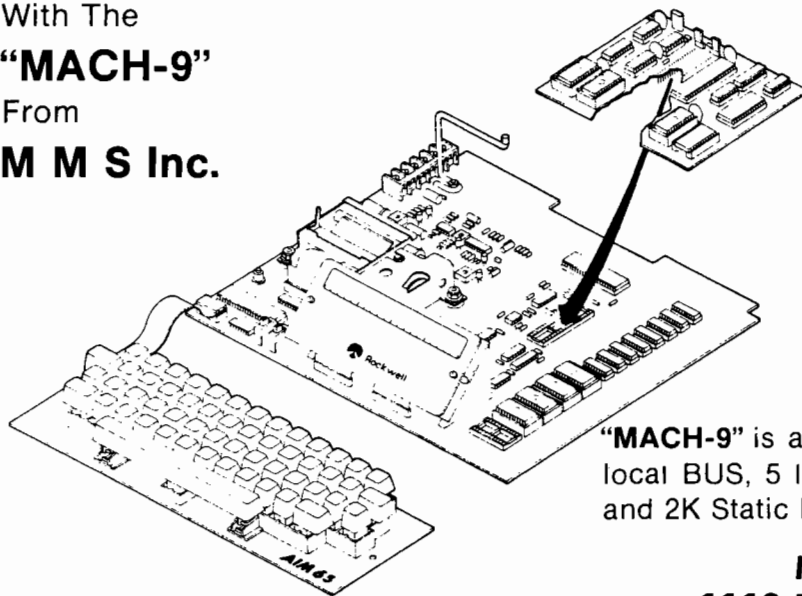

INTRODUCTORY PRICE

**\$239.**

Plus \$6 U.P.S.  
And Handling

Includes:

- \*6809 CPU Plug-in Assembly
- \*Super-set of AIM Monitor
- \*Two-Pass Symbolic Assembler
- \*Complete Monitor Source Listings
- \*Enhanced Cut & Paste Editor
- \*200 Page Manual
- \*Full I/O Control

"MACH-9" is assembled and tested with local BUS, 5 locking low force ROM sockets and 2K Static RAM

M M S Inc.

1110 E. PENNSYLVANIA ST.

TUCSON, AZ 85714

(602) 746-0418



# COMPU SENSE

## VIC-20®

VIC-20®	Personal Computer	\$179.95
VIC-1011A	RS232C Interface	39.95
VIC-1515	Printer	334.95
VIC-1530	Datasette	67.50
VIC-1540	Disk Drive	349.95
VIC-1111	16K RAM Exp.	99.95
VIC-1110	8K RAM Exp.	52.50
VIC-1210	3K RAM Exp.	34.95
VIC-1010	Expansion Module	139.95
VIC-1311	Joystick	9.95
VIC-1312	Game Paddles	19.95
VIC-1600	Telephone Modem	99.95

## BUSINESS & HOME APPLICATIONS

WB101	Total Text 2.5	\$24.95
WB102	Total Labels	19.95
WB103	Total Research	24.95
WB104	Predicator-Linear Regression	16.95
PB105	Billing Solver (20 & 64)	19.95
PB106	Utility Bill Saver (20 & 64)	12.95
WB107	The Gasoline UnGuzzler (20 & 64)	15.95
WB107	Accounting	29.95
WB108	Accounts Receivable	21.95
WB109	Calculator	12.95
WB110	Order Tracker	18.95
WB111	Business Inventory	19.95
WB112	Depreciation	10.95
WB113	Ratios	9.95
WB114	Cash Flow	14.95
WB115	Net Worth	14.95
WB116	Lease / Buy	14.95
WB117	Mortgage Calculator	10.95
WB118	Mortgage Comp.	10.95
WB119	Loan Amortiser	24.95
WB120	Loan Repayer	10.95
WB121	Phone Directory	9.95
WB122	Client Tickler	19.95
WB123	Estimates & Bids	14.95
WB124	Bar Charts	9.95
WB125	Stock Ticker Tape	16.95
WB126	Regress on VIC-20, 64	16.95
WB127	P.E.R.T. MY VIC	15.95
WB128	Business Appointments	13.95
WB129	The Predictor-Linear	16.95
PT130	Billing Solver VIC-20, 64	19.95
PT132	Utility Bill Solver VIC-20, 64	12.95
WB134	Nuismatic Panatic VIC-20, 64	15.95
WB135	The Pill Box VIC-20,64	14.95
PT136	Club Lister VIC-20, 64	14.95
WB137	Mother's Recipes VIC-20, 64	12.95
WB139	Terminal 40	29.95
WB140	Minimon	11.79
WB141	Typewriter	27.95
WB142	Data Files	14.95
SB143SS	Mailing List (Tape) (Disk)	19.95 24.95

## CARDBOARD 6 \$79.95

(Special Christmas Price — after Dec. 15, back to \$99.95)  
An expansion interface for the VIC-20 — allows expansion to 40K or accepts up to six games — may be daisy chained for more versatility.

## CARDBOARD 3 \$29.95

Economy expansion interface for the VIC-20

## CARD "?" CARD/PRINT \$79.95

Universal Centronics Parallel Printer Interface for the VIC-20 or CBM-64. Use an Epson MX-80 or OKIDATA or TANDY or just about any other.

## CARDETTE \$39.95

Use any standard cassette player/recorder with your VIC-20 or CBM-64.

## CARDRITER \$29.95

A light pen with six good programs to use with your VIC-20 or CBM-64.

## GAMES FOR ALL

WG101	Adventure Land (Cart.)	\$37.95
WG102	Mission Impossible (Cart.)	37.95
WG103	Gorf (Cart.)	37.95
WG104	Omega (Cart.)	37.95
WG105	Money Wars	28.95
WG106	Breakout	9.95
WG107	Hangman	9.95
WG108	Monks	7.95
WG109	Tank	17.95
WG110	Simmon	15.95
WG111	Pac Bomber	15.95
WG112	Dam Bomber	15.95
WG113	Cube	14.95
WG114	Spider from Mars	37.95
WG115	Exterminator Plus	19.95
WG116	3-D Hackman	19.95
WG117	Snackman	19.95
WG118	Anti-Matter Splatter	19.95
WG119	Bombs Away	15.95
WG120	3-D Maze Escape	14.95
WG121	Krazy Kong	14.95
WG122	Alien Panic	14.95
WG123	Rescue from Nufon	14.95
WG124	Escapes	14.95
WG125	Journey	14.95
WG126	Invasion	14.95
WK101	Help Chicken Little	14.95
WK102	Mole Attack	19.98
WK103	Car Chase	19.98
WK104	Blue Meanies	11.95
WK105	Space Math	11.95
WK106	Super Slither	11.95
WK107	Spiders of Mars	11.95
WS101	Cribbage	14.95

## EDUCATION

WE101	Find the Words (20 & 64)	\$10.95
WE102	Temperature Converter (20 & 64)	9.95
PE103	The Mathamagican (20 & 64)	14.95
PE104	The Metric Brain (20 & 64)	10.95
WE105	Money Addition Grades 4th & 5th (20)	9.95
WE106	My Body - Elementary (20)	9.95
WE107	Graphics (20)	17.95
WE108	Diagramming Sentences (20)	12.95
WE109	Fraction Reduction (20)	9.95
WE110	Countries (20)	9.95
WE111	Spell (20)	9.95
WE112	State Capitols (20)	9.95
WE113	Tutor Math (20)	9.95
WE115	Math Whiz (20)	12.95

Prices subject to change.

TO ORDER:  
P.O. Box 18765  
Wichita, KS 67218  
(316) 684-4660

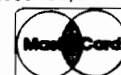

Personal Checks Accepted (Allow 3 Weeks), or C.O.D. (Add \$2.00)  
Handling Charges \$2.00

\* VIC-20 is a registered trademark of Commodore, Inc.



# VIC Hi-Res Graphics Explained

by Nicholas J. Vrtis

**This article demonstrates the use of VIC's 160-by-176 dot, high-resolution graphics. A sample BASIC program illustrates the necessary set-up.**

## VIC Graphics Demo

requires:

VIC-20 with 3K extra memory (may be modified for unexpanded VICs or for more memory)

The VIC manuals refer to the capability of high-resolution graphics. There is even a section in the *VIC-20 Programmer's Reference Guide* that shows how to do 64 by 64 bit graphics. Unfortunately, it is not obvious how it all works. The purpose of this article is to help shed some light on the subject of VIC graphics.

To understand high-resolution graphics you have to understand how programmable characters work. The VIC doesn't really have a "graphics" mode, but it does have two features that allow for graphics displays. The first and most important is that the contents of the pointer that normally points to the character ROM can be changed to point to RAM. The other is that the character size can be changed.

Before explaining how these combine to get graphics, I need to review quickly how characters are normally displayed on the screen. A more detailed explanation can be found in the *Programmer's Reference Guide* and in a number of articles on special characters for the VIC. Each byte in screen memory is used as an index into the character memory. It is actually character memory that tells the VIC which dots to turn on or off in the display. In normal mode a character is 8 rows of 8 dots per row. In expanded character size, a character is 16 rows of 8 dots per row.

By telling the VIC chip that character memory is located in RAM, which dots are turned on or off can be controlled from a program. This is how special characters are created.

So how does this lead to graphics you ask? Good question! If I were to POKE the values 0 through 255 in the

first 256 screen memory locations, all the possible characters would be displayed in order. Now let's take a moment to look at where the bits for each character come from. The first 8 by 8 square of dots (an @) comes from the first 8 bytes of character memory at the rate of 8 bits per byte. The second 8

## Listing 1

```
100 PRINT"VIC GRAPHICS DEMO"
110 PRINT"BY: NICK VRTIS"
120 POKE1,PEEK(55) :REM SAVE CURRENT END
130 POKE2,PEEK(56)
140 POKE55,0 :REM SET NEW END TO 4096
150 POKE56,4096/256
160 CLR :REM CLR BECAUSE END WAS CHANGED
170 CM=4096
180 RC=10
190 CR=22
200 NR=16
210 SF=RC*NR/2-1 :REM SET GRAPH SCALE FACTOR
220 REM ZERO FUTURE CHARACTER MEMORY
230 FOR X=CM TO CM+RC*CR*NR-1
240 POKE X,0 :NEXT
250 REM ALL 1'S TO UNUSED TO MAKE A BORDER
260 FOR X=CM+RC*CR*NR TO 7679
270 POKE X,255:NEXT
280 REM SET TO 3X16 CHARACTER SIZE
290 POKE 36867,PEEK(36867) OR 1
300 BY=PEEK(36879) AND 7 :REM GET CURRENT BACKGROUND
310 FOR X=0 TO RC*CR-1 :REM INDEXES TO SCREEN MEMORY
320 POKE 7680+X,X
330 POKE 38400+X,BY
340 NEXT
350 FOR X=RC*CR TO 511 :REM FILL REST WITH UNUSED CHARACTER
360 POKE7680+X,RC*CR
370 POKE38400+X,BY
380 NEXT
390 REM TELL VIC NUMBER OF CHARACTERS/ROW
400 POKE 36868,(PEEK(36868) AND 128) + CR
410 REM CHANGE ADDRESS OF CHARACTER MEMORY
420 POKE 36869,(PEEK(36869) AND 240) + CM/1024 + 8
500 FOR X=0 TO CR*8-1
510 Y=INT(SF+SF*SIN(X/10)+1)
520 GOSUB 1000
530 NEXT
600 GETA$ :REM WAIT FOR ANY KEY
610 IF A$="" THEN 600
620 POKE55,PEEK(1) :REM RESTORE OLD EOM
630 POKE56,PEEK(2)
640 SYS(59829) :REM RESET VIC CHIP
650 END
1000 YR=Y*NR
1010 CH=INT(X/8)+INT(YR)*CR
1020 RW=(YR-INT(YR))*NR
1030 BY=CM+CH*NR+RW
1040 BI=7-(X-INT(X/8))*8
1050 POKEBY,PEEK(BY) OR (2^BI)
1060 RETURN
```

by 8 square of dots comes from the second 8 bytes of character memory, etc. What is being displayed on the screen is not the 256 displayable VIC characters, but all the bits that are set in the 2048 bytes starting at the address defined as character memory! (256 indexes \* 8 rows \* 8 dots = 16384 dots = 2048 bytes \* 8 bits).

With this knowledge I can calculate which bit in which byte is to be set to a one in order to turn on a selected dot. The following formulas are adapted from the *VIC Programmers Reference Guide*.

CHAR = INT(X/8) + INT(Y/NR) \* CR  
 ROW = (Y/NR - INT(Y/NR)) \* NR  
 BYTE = SM + CHAR \* NR + ROW  
 BIT = 7 - (X - (INT(X/8) \* 8))

For these formulas, X represents ascending values to the right, and Y represents ascending values from the top down. CR is the number of characters per row, which we will discuss later, and NR is the number of rows of dots per character (8 for normal size characters).





There is only one more major observation to make. As everyone knows, the VIC screen is 22 characters by 23 rows, for a total of 506 characters being displayed at one time. How can I fill a screen of 506 characters with only 256 unique combinations? The trick is double-height characters. The double-height characters don't change the dot size displayed on the screen, so each "character" covers twice as much screen area.

To put things a little differently, the VIC screen is 176 dots wide by 184 dots high, for a total of 32384 dots (4048 bytes). The double-high characters provide for 32768 dots (256 indexes \* 16 rows \* 8 dots per), so obviously all the problems are taken care of, right? Wrong. The problem is the memory the VIC chip itself can address. As stated in the expansion modules, the VIC chip (as opposed to the VIC computer), can only address memory from 4096 to 8191 (hex \$1000 to \$1FFF). While this 4096 bytes is sufficient to hold a full set of double-high character memory, we still need to take the 512 bytes of screen memory from this same area.

We've discussed most of the information you use to do graphics on the VIC. There are a few minor technical details left and compromises concerning the amount of graphics and memory needed for BASIC. Character memory can start at one of four RAM locations: 4096, 5120, 6144, or 7168 (with a 12, 13, 14, or 15 in the last four bits of location 36869). Screen memory can be at any of eight RAM locations: 4096, 4608, 5120, 5632, 6144, 6656, 7168, or 7680 (bits 4-7 of location 36869 control which 1024 boundary, and bit 7 of location 36866 controls whether it is an even 1024 or 512 boundary). Character and screen memory are set independently, and can even occupy the same locations. In fact, for the maximum resolution graphics, they have to overlap some. If character memory is set to 4096, and screen memory to start at 7680 by:

POKE 36869,(PEEK(36869) AND 240) + 12

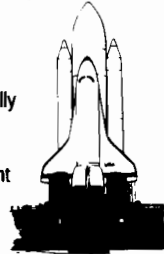
there are 3584 bytes available for

<p><b>THE MONKEY WRENCH</b> A PROGRAMMER'S AID FOR ATARI 800</p> <p>If you are a person who likes to monkey around with the ATARI 800 — Then THE MONKEY WRENCH is for you! Make programming tasks easier, less time consuming and more fun. Why spend extra hours working on a BASIC program when the MONKEY can do it for you. Plugs in the RIGHT cartridge slot and works with ATARI BASIC.</p>  <p>The Monkey Wrench provides 9 new BASIC direct mode commands. They include: AUTO LINE NUMBERING, DELETE LINE NUMBERS, CHANGE MARGINS, MEMORY TEST, RENUMBER CURSOR EXCHANGE, HEX &amp; DECIMAL CONVERSION, and MONITOR. The monitor command gives access to a machine language monitor with 15 commands used to interact with the powerful features of the 6502 microprocessor.</p> <p><b>\$49.95</b></p>	<p><b>VIC RABBIT CARTRIDGE</b></p> <p>"High-Speed Cassette Load and Save!"</p>  <p><b>\$39.95</b> (includes Cartridge and Manual)</p> <p>Expansion Connector</p> <p>"Don't waste your Life away waiting to LOAD and SAVE programs on Cassette Deck." Load or Save 8K in approximately 30 seconds! Try it — your Un-Rabbitized VIC takes almost 3 minutes. It's not only Fast but VERY RELIABLE. Almost as fast as VIC Disk Drive! Don't be foolish — Why buy the disk when you can get the VIC Rabbit for much, much less! Easy to install — it just plugs in. Expansion Connector on rear. Works with or without Expansion Memory. Works with VIC Cassette Deck. 12 Commands provide other neat features. Also Available for 2001, 4001, and 8032</p>	<p><b>More than just an Assembler/Editor!</b></p> <p><b>MAE</b> for PET APPLE ATARI <b>\$169.95</b></p>  <p><b>It's a Professionally Designed Software Development System</b></p> <p><b>Blast off with the software used on the space shuttle project!</b></p> <ul style="list-style-type: none"> <li>• Designed to improve Programmer Productivity</li> <li>• Similar syntax and commands - No need to relearn peculiar syntaxes and commands when you go from PET to APPLE to ATARI</li> <li>• Coresident Assembler/Editor - No need to load the Editor then the Assembler then the Editor, etc.</li> <li>• Also includes Word Processor, Relocating Loader, and much more</li> <li>• Options: EPROM Programmer, unimplemented opcode circuitry</li> <li>• STILL NOT CONVINCED? Send for free spec sheet!</li> </ul>
<p><b>ATARI AND PET EPROM PROGRAMMER</b></p> <p>Programs 2716 and 2532 EPROMs. Includes hardware and software. PET = \$75.00 - ATARI (includes sophisticated machine language monitor) = \$119.95</p>  <p>Prowriter Printer - Excellent dot matrix print. Parallel = \$489.00 Serial = \$600.00. IEEE = \$589.00</p>	<p><b>PET TERMINAL SOFTWARE</b></p> <p>A buy you RS-232 users can't pass-up. Includes RS-232 hardware with a sophisticated software package. May be controlled via keyboard or from BASIC. A super buy. \$129.95</p> <p>DC Hayes Smart Modem = \$235.00 DC Hayes Micro Modem II = \$289.00</p> <p>Rana Disk Drive - 375 4 Drive Controller - 114</p>	<p><b>5 1/4 INCH SOFT SECTORED DISKETTES</b></p> <p>Highest quality. We use them on our PETs, APPLES, ATARIs, and other computers. \$22.50/10 or \$44.50/20</p> <p>EPROMS 2716 = \$6.50, 2532 = \$12.50 Over 40 Commodore Programs by Baker (on 4040) = \$25.00</p> 

**Eastern House**

3239 Linda Dr.  
Winston-Salem, N.C. 27106  
(919) 924-2889 (919) 748-8446  
Send for free catalog!



graphics. This allows for 22 columns by 10 rows, or 176 dots across by 160 dots down (each row is 16 dots high with double-height characters). It doesn't allow for room for a BASIC program on an unexpanded VIC. If you want room for a 1K BASIC program, move character memory to 5120, and keep screen memory at 7680 with the following:

```
POKE 36869,(PEEK(36869) AND 240)
+ 13
```

This allows for 2560 bytes of graphics data, and a default grid of 176 dots (22 characters) by 112 dots down (7 double-high characters) using 2464 bytes. That is not a very square area to graph in, so use the following to change the number of characters per row from 22 to 17:

```
POKE 36866,(PEEK(36866) AND 128)
+ 17
```

This gives 136 dots across by 144 dots down.

Note that all this discussion applies to unexpanded VICs, or VICs with only the 3K expander. There is one further complication for VICs with more than 8K. For these systems, the screen memory defaults to location 4096, and the BASIC program starts at 4608. In order to use graphics with these systems, the start of the BASIC program must be moved above the area used for the screen and character memory (i.e., above 8191). Under the right conditions, it can be done by the BASIC program that is running, but it is much simpler to do before loading the program.

The program included with this article is a sample of how to use high-resolution graphics with the VIC. If you look at it, you will find that most of the program is involved in setting things up, and that lines 500 to 530 are the ones that create the actual graph (a simple sine curve). The program as shown is for a VIC with the 3K expander. If you have an unexpanded VIC, change the following lines and remove all the REMs. This will give a 136 by 144 dot field.

```
150 POKE56,5120/256
170 CM = 5120
180 RC = 7
190 CR = 17
```

If you have the 8K expander you should remove statements 150 and

160, since the end of memory is above screen memory. You will also have to enter the following statements in direct mode before loading the BASIC program. These statements move screen memory to where it is on the standard VIC, and also set the start of the BASIC program to just above screen memory. This lets us use memory from 4096-7680 as character memory.

```
POKE 36866,150:POKE 36869,240:
POKE 648,30
POKE 43,1:POKE 44,32
POKE 8192,0
CLR:NEW
```

You should press the CLR/HOME key to clear the screen after typing in the first line. This will tell BASIC you changed the screen location.

Lines 120-160 establish a new top of memory, which is below where the new character memory will be. The CLR makes sure BASIC doesn't use any of that memory. Lines 170-210 set up constants used later.

CM is the location of character memory  
 RC is the number of row characters  
 CR is the number of characters per row  
 NR is the number of dots per row character  
 SF is a scale factor to center the sine curve

Note that RC\*NR is the number of dot rows, and CR\*8 is the number of dots wide.

The loop at 230 initializes the character memory we will use for the graph to zeros, while the one starting at 260 initializes the rest of character memory to ones. Note that these loops initialize a lot of memory, so they take a few seconds to run.

Lines 310-340 POKE the numbers 0-219 (153 for unexpanded VICs) to screen memory, while lines 350-380 POKE an unused character into the rest of screen memory. Since the location of character memory has not been changed yet, you will get a demonstration of the VIC character set.

Lines 400 and 420 change the characters per row (only necessary for the unexpanded version), and move character memory to the RAM area we have set up previously. Since a one bit on displays the border color, and we have initialized all the unused character memory to ones, the screen will appear to shrink at this time.

Lines 500-530 plot the sine curve by calling the plot routine at lines 1000-1060. This routine was described earlier.

Lines 600 and 610 allow you to admire your work by waiting for a key to be pressed. Then lines 620 and 630 reset the top of memory back to their original values. The SYS(59829) resets the VIC chip to its normal default values.

Nick Vrtis is the Manager of Technical Support at Amway Corporation. You may contact him at 5863 Pinetree S.E., Kentwood, MI 49508.



## VIC-20

**VIC-20 INTERFACING BLUE BOOK**

Did you know that your VIC can be used to control a 99¢ toy motor so effectively that it runs like a precision machine? Or that you can build an accurate digital thermometer using the VIC and four parts costing less than \$5?

These and other 18 interfacing projects selected for usefulness, ease of construction and low cost are detailed in the VIC-20 Interfacing Blue Book, a veritable gold mine of practical information on how to build a variety of interfaces for your computer.

Projects include: Connecting VIC to your stereo; Pickproof digital lock; Capacitance meter; Liquid level sensor; Telephone dialer; Voice output; 8K/16K RAM/ROM expansion; 128K RAM expansion; 8-bit precision D/A; 8-bit A/D converter; MX-80 interface and more.

Written by a college professor in a friendly and informative style, the Blue Book gives you theory of operation, schematics, program listings, parts list, construction hints and sources of materials for each one of the 20 projects.

If you want to get the most out of your VIC this book is a must. Cost is \$14.95 (less than 75¢ per project!). Price includes postage.

**microsignal** Dept N  
 P.O. BOX 22  
 MILLWOOD NY 10548

Please send me a copy of the Blue Book.  
 Enclosed my check for \$ \_\_\_\_\_

NAME \_\_\_\_\_

ADDRESS \_\_\_\_\_

\_\_\_\_\_

Above prices include postage in the U.S. CA res. add 6% tax. Foreign add \$2.

# DTACK

10

## The 68000 DREAM MACHINE

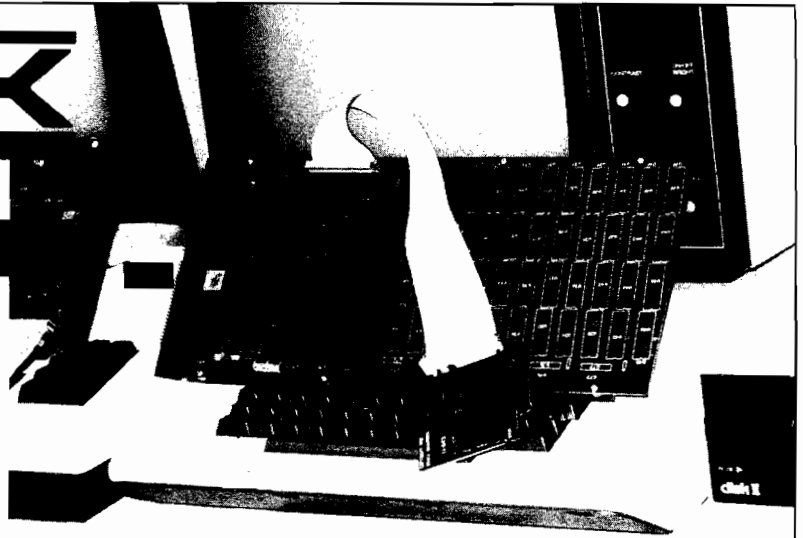

### WE (SORT OF) LIED:

Motorola has been promoting its advanced microprocessor chip as a vehicle for large, complex systems **exclusively**. Now, the 68000 does work well as the heart of big, complex systems. But their promotional literature implies that one can **only** build big, complex systems with the 68000, and that is dead wrong (in our opinion). Nevertheless, the public (that's you!) perception of the 68000 follows Motorola's line: **Big systems. Complex systems.**

Our boards are **not** complex and not necessarily big (starting at 4K). Our newsletter is subtitled "The Journal of Simple 68000 Systems." But since the public has become conditioned to the 68000 as a vehicle for FORTRAN, UNIX, LISP, PASCAL and SMALLTALK people naturally expect all these with our \$595 (starting price) simple attached processor. **Wrong!**

We wrote our last ad to **understate** the software we have available because we wanted to get rid of all those guys who want to run (multi-user, multi-tasking) UNIX on their Apple II and two floppy disks. Running UNIX using two 143K floppies is, well, absurd. The utilities alone require more than 5 megabytes of hard disk.

### HERE'S THE TRUTH:

We **do** have some very useful 68000 utility programs. One of these will provide, in conjunction with a suitable BASIC compiler such as PETSPEED (Pet/CBM) or TASC (Apple II), a five to twelve times speedup of your BASIC program. If you have read a serious compiler review, you will have learned that compilers cannot speed up floating point operations (especially transcendental). Our board, and the utility software we provide, **does** speed up those operations.

Add this line in front of an Applesoft program:

```
5 PRINT CHR$(4);"BLOADUTIL4,AS$8600":CALL38383
```

That's all it takes to link our board into Applesoft (assuming you have Applesoft loaded into a 16K RAM card). Now run your program as is for faster number-crunching or compile it to add the benefit of faster "interpretation". Operation with the Pet/CBM is similar.

### 68000 SOURCE CODE:

For Apple II users only, we provide a nearly full disk of **unprotected** 68000 source code. To use it you will have to have DOS toolkit (\$75) and ASSEM68K (\$95), both available from third parties. Here's what you get:

1) 68000 source code for our Microsoft compatible floating point package, including LOG, EXP, SQR, SIN, COS, TAN, ATN along with the basic four functions. The code is set up to work either linked into BASIC or with our developmental HALGOL language. 85 sectors.

2) 68000 source code for the PROM monitor. 35 sectors.

3) 68000 source code for a very high speed interactive 3-D graphics demo. 115 sectors.

4) 68000 source code for the HALGOL threaded interpreter. Works with the 68000 floating point package. 56 sectors.

5) 6502 source code for the utilities to link into the BASIC floating point routines and utility and debug code to link into the 68000 PROM monitor. 113 sectors.

The above routines almost fill a standard Apple DOS 3.3 floppy. We provide a second disk (very nearly filled) with various utility and demonstration programs.

### SWIFTUS MAXIMUS:

Our last advertisement implied that we sold 8MHz boards to hackers and 12.5MHz boards to businesses. That was sort of true because when that ad was written the 12.5MHz 68000 was a very expensive part (list \$332 ea). Motorola has now dropped the price to \$111 and we have adjusted our prices accordingly. So now even hackers can afford a 12.5MHz 68000 board. With, we remind you, **absolutely zero wait states**.

'Swiftus maximus'? Do you know of any other microprocessor based product that can do a 32 bit add in 0.48 microseconds?

### AN EDUCATIONAL BOARD?

If you want to learn how to program the 68000 at the assembly language level there is no better way than to have one disk full of demonstration programs and another disk full of machine readable (and user-modifiable) 68000 source code.

Those other 'educational boards' have 4MHz clock signals (even the one promoted as having a 6MHz CPU, honest!) so we'll call them **slow learners**. They do not come with any significant amount of demo or utility software. And they communicate with the host computer via RS 232, 9600 baud max. That's 1K byte/sec. Our board communicates over a parallel port with hardware AND software handshake, at 71K bytes/sec! We'll call those other boards **handicapped learners**.

Our board is definitely not for everyone. But some people find it very, very useful. Which group do you fit into?

**DIGITAL ACOUSTICS**  
1415 E. McFadden, Ste. F  
Santa Ana, CA 92705  
(714) 835-4884



# 68000 Shift, Rotate, and Bit Manipulation Instructions

by Joe Hootman

Our series on 68000 instructions continues. Previous detailed tables appeared in September, November, and December.

## The Shift and Rotate Instructions

The shift and rotate operations implemented in the 68000 are delineated in table 1. The distinction between shift and rotate is that shift does not preserve the bits as they leave the register except in the carry bit. Rotate, on the other hand, cycles the bits around the register to the most significant bit position or to the least significant bit position, depending on whether rotate is a rotate right or a rotate left.

Another interesting point is that registers can be shifted/rotated any number of bits by denoting the bit count in a preassigned data register. Memory can be shifted/rotated only one bit at a time. This suggests there might be a time savings if the data in the memory were brought from memory to a register location before shifting. This is true; and if three or more shifts are to be done on data in memory, it should be put into a register for shifting.

## Table of Definitions of Opword Formats for Shift and Rotate

i/r = 0 Immediate shift count. The shift count is specified by this to range between 1 and 8 shifts. Zero in the count register results in a shift of 8. The rest of the bits denote a shift of 1 to 7.

i/r = 1 Register shift count. The shift count is contained in the data register denoted.

dr = 0 Shift Right

dr = 1 Shift Left

Table 1: Shift and Rotate Instructions

Mnemonic	Data Size/CCR	Name	Comments																																
ASL ASR	8, 16, 32 CCR X N Z V C * * * * *	Arithmetic Shift, Left and Right	The arithmetic shift will shift the bits in the destination by a predetermined number of times and the carry bit receives the last bit shifted out. The shift count can be specified either by immediate data or by the contents of a data register.																																
Opword Format																																			
<table border="1" style="width: 100%; border-collapse: collapse;"> <tr> <td style="width: 2.5%;">15</td><td style="width: 2.5%;">14</td><td style="width: 2.5%;">13</td><td style="width: 2.5%;">12</td><td style="width: 2.5%;">11</td><td style="width: 2.5%;">10</td><td style="width: 2.5%;">9</td><td style="width: 2.5%;">8</td><td style="width: 2.5%;">7</td><td style="width: 2.5%;">6</td><td style="width: 2.5%;">5</td><td style="width: 2.5%;">4</td><td style="width: 2.5%;">3</td><td style="width: 2.5%;">2</td><td style="width: 2.5%;">1</td><td style="width: 2.5%;">0</td> </tr> <tr> <td>1</td><td>1</td><td>1</td><td>0</td><td>Count/ Register</td><td>dr</td><td>Size</td><td>i/r</td><td>0</td><td>0</td><td>Register</td><td colspan="5"></td> </tr> </table>				15	14	13	12	11	10	9	8	7	6	5	4	3	2	1	0	1	1	1	0	Count/ Register	dr	Size	i/r	0	0	Register					
15	14	13	12	11	10	9	8	7	6	5	4	3	2	1	0																				
1	1	1	0	Count/ Register	dr	Size	i/r	0	0	Register																									
Register Shifts																																			
<table border="1" style="width: 100%; border-collapse: collapse;"> <tr> <td style="width: 2.5%;">1</td><td style="width: 2.5%;">1</td><td style="width: 2.5%;">1</td><td style="width: 2.5%;">0</td><td style="width: 2.5%;">0</td><td style="width: 2.5%;">0</td><td style="width: 2.5%;">dr</td><td style="width: 2.5%;">1</td><td style="width: 2.5%;">1</td><td colspan="7">Effective Address Mode Register</td> </tr> </table>				1	1	1	0	0	0	dr	1	1	Effective Address Mode Register																						
1	1	1	0	0	0	dr	1	1	Effective Address Mode Register																										
Memory Shifts																																			
The following effective addressing modes cannot be used in the memory rotate: 1, 2, 11, 12, 13, 14.*																																			
LSL LSR	8, 16, 32 CCR X N Z V C * * * 0 *	Logical Shift Left and Right	The logical shift will shift the bits in the destination a predetermined number of times and the carry bit receives the last bit shifted out. The shift count can be specified either by the immediate data or the contents of a data register.																																
Opword Format																																			
<table border="1" style="width: 100%; border-collapse: collapse;"> <tr> <td style="width: 2.5%;">15</td><td style="width: 2.5%;">14</td><td style="width: 2.5%;">13</td><td style="width: 2.5%;">12</td><td style="width: 2.5%;">11</td><td style="width: 2.5%;">10</td><td style="width: 2.5%;">9</td><td style="width: 2.5%;">8</td><td style="width: 2.5%;">7</td><td style="width: 2.5%;">6</td><td style="width: 2.5%;">5</td><td style="width: 2.5%;">4</td><td style="width: 2.5%;">3</td><td style="width: 2.5%;">2</td><td style="width: 2.5%;">1</td><td style="width: 2.5%;">0</td> </tr> <tr> <td>1</td><td>1</td><td>1</td><td>0</td><td>Count/ Register</td><td>dr</td><td>Size</td><td>i/r</td><td>0</td><td>1</td><td>Register</td><td colspan="5"></td> </tr> </table>				15	14	13	12	11	10	9	8	7	6	5	4	3	2	1	0	1	1	1	0	Count/ Register	dr	Size	i/r	0	1	Register					
15	14	13	12	11	10	9	8	7	6	5	4	3	2	1	0																				
1	1	1	0	Count/ Register	dr	Size	i/r	0	1	Register																									
Register Shifts																																			
<table border="1" style="width: 100%; border-collapse: collapse;"> <tr> <td style="width: 2.5%;">1</td><td style="width: 2.5%;">1</td><td style="width: 2.5%;">1</td><td style="width: 2.5%;">0</td><td style="width: 2.5%;">0</td><td style="width: 2.5%;">0</td><td style="width: 2.5%;">dr</td><td style="width: 2.5%;">1</td><td style="width: 2.5%;">1</td><td colspan="7">Effective Address Mode Register</td> </tr> </table>				1	1	1	0	0	0	dr	1	1	Effective Address Mode Register																						
1	1	1	0	0	0	dr	1	1	Effective Address Mode Register																										
Memory Shifts																																			
The following effective addressing modes cannot be used in the memory rotate: 1, 2, 11, 12, 13, 14.*																																			

(continued)

Table 1 (continued)

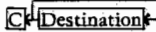
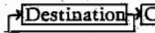
Mnemonic	Data Size/CCR	Name	Comments																
ROL ROR	8, 16, 32 CCR X N Z V C * * * 0 *	Rotate without extension	The destination is rotated as indicated below. The extension bit is not included in the rotation. The number of times the rotate is performed can be specified immediately or by data in a register.  ROL  ROR 																
Opword Format																			
15 14 13 12 11 10 9 8 7 6 5 4 3 2 1 0																			
<table border="1" style="width: 100%; border-collapse: collapse;"> <tr> <td style="width: 2.5%;">1</td><td style="width: 2.5%;">1</td><td style="width: 2.5%;">1</td><td style="width: 2.5%;">0</td> <td style="width: 10%;">Count/ Register</td> <td style="width: 2.5%;">dr</td> <td style="width: 2.5%;">Size</td> <td style="width: 2.5%;">i/r</td> <td style="width: 2.5%;">1</td> <td style="width: 2.5%;">1</td> <td style="width: 2.5%;">1</td> <td style="width: 2.5%;">1</td> <td style="width: 2.5%;">1</td> <td style="width: 2.5%;">1</td> <td style="width: 2.5%;">1</td> <td style="width: 2.5%;">0</td> </tr> </table>				1	1	1	0	Count/ Register	dr	Size	i/r	1	1	1	1	1	1	1	0
1	1	1	0	Count/ Register	dr	Size	i/r	1	1	1	1	1	1	1	0				
Register Rotate																			
<table border="1" style="width: 100%; border-collapse: collapse;"> <tr> <td style="width: 2.5%;">1</td><td style="width: 2.5%;">1</td><td style="width: 2.5%;">1</td><td style="width: 2.5%;">0</td> <td style="width: 10%;">0</td> <td style="width: 2.5%;">1</td> <td style="width: 2.5%;">dr</td> <td style="width: 2.5%;">1</td> <td style="width: 2.5%;">1</td> <td style="width: 2.5%;">1</td> <td style="width: 2.5%;">1</td> <td style="width: 2.5%;">1</td> <td style="width: 2.5%;">1</td> <td style="width: 2.5%;">1</td> <td style="width: 2.5%;">1</td> <td style="width: 2.5%;">0</td> </tr> </table>				1	1	1	0	0	1	dr	1	1	1	1	1	1	1	1	0
1	1	1	0	0	1	dr	1	1	1	1	1	1	1	1	0				
Memory Rotate																			
The following effective addressing modes cannot be used in the memory rotate: 1, 2, 10, 11, 12, 13, 14.*																			



ROXL ROXR	8, 16, 32 CCR X N Z V C * * * 0 *	Rotate with extension	The bits in the destination will be rotated as specified below and the extended bit is included in the rotation. The number of times the rotation is to be performed is specified immediately or by data in a register.  ROXL  ROXR 																
Opword Format																			
15 14 13 12 11 10 9 8 7 6 5 4 3 2 1 0																			
<table border="1" style="width: 100%; border-collapse: collapse;"> <tr> <td style="width: 2.5%;">1</td><td style="width: 2.5%;">1</td><td style="width: 2.5%;">1</td><td style="width: 2.5%;">0</td> <td style="width: 10%;">Count/ Register</td> <td style="width: 2.5%;">dr</td> <td style="width: 2.5%;">Size</td> <td style="width: 2.5%;">i/r</td> <td style="width: 2.5%;">1</td> <td style="width: 2.5%;">0</td> <td style="width: 2.5%;">0</td> <td style="width: 2.5%;">0</td> <td style="width: 2.5%;">0</td> <td style="width: 2.5%;">0</td> <td style="width: 2.5%;">0</td> <td style="width: 2.5%;">0</td> </tr> </table>				1	1	1	0	Count/ Register	dr	Size	i/r	1	0	0	0	0	0	0	0
1	1	1	0	Count/ Register	dr	Size	i/r	1	0	0	0	0	0	0	0				
Register Rotate																			
<table border="1" style="width: 100%; border-collapse: collapse;"> <tr> <td style="width: 2.5%;">1</td><td style="width: 2.5%;">1</td><td style="width: 2.5%;">1</td><td style="width: 2.5%;">0</td> <td style="width: 10%;">0</td> <td style="width: 2.5%;">0</td> <td style="width: 2.5%;">dr</td> <td style="width: 2.5%;">1</td> <td style="width: 2.5%;">1</td> <td style="width: 2.5%;">1</td> <td style="width: 2.5%;">1</td> <td style="width: 2.5%;">1</td> <td style="width: 2.5%;">1</td> <td style="width: 2.5%;">1</td> <td style="width: 2.5%;">1</td> <td style="width: 2.5%;">0</td> </tr> </table>				1	1	1	0	0	0	dr	1	1	1	1	1	1	1	1	0
1	1	1	0	0	0	dr	1	1	1	1	1	1	1	1	0				
Memory Rotate																			
The following effective addressing modes cannot be used in the memory rotate: 1, 2, 11, 12, 13, 14.*																			

Table 2: Bit Manipulation Instructions

Mnemonic	Data Size/CCR	Name	Comments																
BCHG	8, 32 CCR X N Z V C * * * * *	Test a Bit and Change	A bit in a particular bit position can be tested and its state reflected in the Z bit of the CCR. The state of the bit is changed in the destination.  Opword Format 15 14 13 12 11 10 9 8 7 6 5 4 3 2 1 0 <table border="1" style="width: 100%; border-collapse: collapse;"> <tr> <td style="width: 2.5%;">0</td><td style="width: 2.5%;">0</td><td style="width: 2.5%;">0</td><td style="width: 2.5%;">0</td> <td style="width: 10%;">Register</td> <td style="width: 2.5%;">1</td> <td style="width: 2.5%;">0</td> <td style="width: 2.5%;">1</td> <td style="width: 2.5%;">1</td> <td style="width: 2.5%;">1</td> <td style="width: 2.5%;">1</td> <td style="width: 2.5%;">1</td> <td style="width: 2.5%;">1</td> <td style="width: 2.5%;">1</td> <td style="width: 2.5%;">1</td> <td style="width: 2.5%;">0</td> </tr> </table> Register The bit number that is to be tested and changed is contained in a data register defined by a register number in the register field. The effective address specifies the destination.  The following effective addressing modes cannot be used: 2, 10, 11, 12, 13, 14.*	0	0	0	0	Register	1	0	1	1	1	1	1	1	1	1	0
0	0	0	0	Register	1	0	1	1	1	1	1	1	1	1	0				

(continued)

Size field  
 00 - Byte operation  
 01 - Word operation  
 10 - Long word operation  
 Register field — Specifies data register to be shifted.

**Bit Manipulation Instructions**

Table 2 describes the bit testing and manipulation instructions which exist in the 68000. Bit manipulation instructions are used to test, test and set, bit test and change, or test and reset a bit. The result of a test is found in the Z bit of the CCR. The bit to be tested is specified by a bit number in a specified data register or by a bit number in the extension word. Notice that BCHG, BCLR, and BSET all test bits and then may change the state of the bit. These instructions do not apply directly to the address register.

Contact Professor Hootman at the University of North Dakota, Dept. of Electrical Engineering, University Station, Grand Forks, ND 58202.

Interesting Software

presents

OSI C4P-MF SOFTWARE

ATR PATROL



YOU MUST PILOT YOUR WWII VINTAGE AIRCRAFT ACROSS A SCROLLING LANDSCAPE AND RESCUE POW'S IN ENEMY TERRITORY. SOME OF THE SMOOTHEST GRAPHICS EVER SEEN ON AN OSII! IT ALSO USES A NEW TECHNIQUE OF USING "LARGE" MULTI-CHARACTER SHAPES FOR A REALISTIC GAME. YOU WILL REALLY LOVE THIS ONE! PLEASE SPECIFY WHETHER YOU WANT JOY-STICK OR KEYBOARD OPTIONS. THIS GAME IS SO EXTENSIVE THAT IT TAKES UP THE ENTIRE DISK!  
 ALL THIS FOR ONLY \$19.95

SEND TO: INTERESTING SOFTWARE  
 21101 S. HARVARD BLVD.  
 TORRANCE, CA 90501  
 (213) 328-9422

Calif. residents  
 add sales tax

Table 2 (continued)

Mnemonic	Data Size/CCR	Name	Comments																																																																																																
			<p style="text-align: center;">Opword Format</p> <table border="1" style="width: 100%; text-align: center;"> <tr> <td>15</td><td>14</td><td>13</td><td>12</td><td>11</td><td>10</td><td>9</td><td>8</td><td>7</td><td>6</td><td>5</td><td>4</td><td>3</td><td>2</td><td>1</td><td>0</td> </tr> <tr> <td>0</td><td>0</td><td>0</td><td>0</td><td>1</td><td>0</td><td>0</td><td>0</td><td>0</td><td>1</td><td colspan="6">Effective Address Mode Register</td> </tr> <tr> <td colspan="10">Bit number</td> <td colspan="6"></td> </tr> </table> <p style="text-align: center;">Immediate</p> <p>The bit number that is to be tested and changed is contained in the immediate word following the opword. The effective address specifies the destination location. The following effective address modes cannot be used: 2, 10, 11, 12, 13, 14.*</p>	15	14	13	12	11	10	9	8	7	6	5	4	3	2	1	0	0	0	0	0	1	0	0	0	0	1	Effective Address Mode Register						Bit number																																																															
15	14	13	12	11	10	9	8	7	6	5	4	3	2	1	0																																																																																				
0	0	0	0	1	0	0	0	0	1	Effective Address Mode Register																																																																																									
Bit number																																																																																																			
BCLR	8, 32 CCR X N Z V C - - - - -	Test a Bit and Clear	<p>The state of a particular bit in the destination is tested and its state reflected in the Z bit of the CCR. The particular bit is cleared in the destination.</p> <p style="text-align: center;">Opword Format</p> <table border="1" style="width: 100%; text-align: center;"> <tr> <td>15</td><td>14</td><td>13</td><td>12</td><td>11</td><td>10</td><td>9</td><td>8</td><td>7</td><td>6</td><td>5</td><td>4</td><td>3</td><td>2</td><td>1</td><td>0</td> </tr> <tr> <td>0</td><td>0</td><td>0</td><td>0</td><td colspan="2">Register</td><td>1</td><td>1</td><td>0</td><td colspan="7">Effective Address Mode Register</td> </tr> <tr> <td colspan="10">Register</td> <td colspan="6"></td> </tr> </table> <p style="text-align: center;">Register</p> <p>The bit number that is contained in the data register defines the bit to be tested and cleared. The effective address specifies the destination. The following effective address modes cannot be used: 2, 10, 11, 12, 13, 14.*</p> <p style="text-align: center;">Opword Format</p> <table border="1" style="width: 100%; text-align: center;"> <tr> <td>15</td><td>14</td><td>13</td><td>12</td><td>11</td><td>10</td><td>9</td><td>8</td><td>7</td><td>6</td><td>5</td><td>4</td><td>3</td><td>2</td><td>1</td><td>0</td> </tr> <tr> <td>0</td><td>0</td><td>0</td><td>0</td><td>1</td><td>0</td><td>0</td><td>0</td><td>1</td><td>0</td><td colspan="6">Effective Address Mode Register</td> </tr> <tr> <td colspan="10">Bit number</td> <td colspan="6"></td> </tr> </table> <p style="text-align: center;">Immediate</p> <p>The effective address specifies the destination location. The following effective addresses cannot be used: 2, 10, 11, 12, 13, 14.*</p>	15	14	13	12	11	10	9	8	7	6	5	4	3	2	1	0	0	0	0	0	Register		1	1	0	Effective Address Mode Register							Register																15	14	13	12	11	10	9	8	7	6	5	4	3	2	1	0	0	0	0	0	1	0	0	0	1	0	Effective Address Mode Register						Bit number															
15	14	13	12	11	10	9	8	7	6	5	4	3	2	1	0																																																																																				
0	0	0	0	Register		1	1	0	Effective Address Mode Register																																																																																										
Register																																																																																																			
15	14	13	12	11	10	9	8	7	6	5	4	3	2	1	0																																																																																				
0	0	0	0	1	0	0	0	1	0	Effective Address Mode Register																																																																																									
Bit number																																																																																																			
BSET	8, 32 CCR X N Z V C - - - - -	Test a Bit and Set	<p>The bit in the destination is tested and the state of the bit is reflected in the Z bit of the CCR. The specified bit is set in the destination.</p> <p style="text-align: center;">Opword Format</p> <table border="1" style="width: 100%; text-align: center;"> <tr> <td>15</td><td>14</td><td>13</td><td>12</td><td>11</td><td>10</td><td>9</td><td>8</td><td>7</td><td>6</td><td>5</td><td>4</td><td>3</td><td>2</td><td>1</td><td>0</td> </tr> <tr> <td>0</td><td>0</td><td>0</td><td>0</td><td colspan="2">Register</td><td>1</td><td>1</td><td>1</td><td colspan="7">Effective Address Mode Register</td> </tr> <tr> <td colspan="10">Register</td> <td colspan="6"></td> </tr> </table> <p style="text-align: center;">Register</p> <p>The bit number contained in the data register specified by the register field is the bit to be tested.</p> <p>The effective address specifies the destination location. The following effective address modes cannot be used: 2, 10, 11, 12, 13, 14.*</p> <p style="text-align: center;">Opword Format</p> <table border="1" style="width: 100%; text-align: center;"> <tr> <td>15</td><td>14</td><td>13</td><td>12</td><td>11</td><td>10</td><td>9</td><td>8</td><td>7</td><td>6</td><td>5</td><td>4</td><td>3</td><td>2</td><td>1</td><td>0</td> </tr> <tr> <td>0</td><td>0</td><td>0</td><td>0</td><td>1</td><td>0</td><td>0</td><td>0</td><td>1</td><td>1</td><td colspan="6">Effective Address Mode Register</td> </tr> <tr> <td colspan="10">Bit number</td> <td colspan="6"></td> </tr> </table> <p style="text-align: center;">Immediate</p> <p>The effective address specifies the destination location and the bit number specifies the bit to be tested. The following effective address modes cannot be used: 2, 10, 11, 12, 13, 14.*</p>	15	14	13	12	11	10	9	8	7	6	5	4	3	2	1	0	0	0	0	0	Register		1	1	1	Effective Address Mode Register							Register																15	14	13	12	11	10	9	8	7	6	5	4	3	2	1	0	0	0	0	0	1	0	0	0	1	1	Effective Address Mode Register						Bit number															
15	14	13	12	11	10	9	8	7	6	5	4	3	2	1	0																																																																																				
0	0	0	0	Register		1	1	1	Effective Address Mode Register																																																																																										
Register																																																																																																			
15	14	13	12	11	10	9	8	7	6	5	4	3	2	1	0																																																																																				
0	0	0	0	1	0	0	0	1	1	Effective Address Mode Register																																																																																									
Bit number																																																																																																			

(continued)

# A harvest of savings from



## Apple Tree Electronics

### SOFTWARE

**APPLE • ATARI • TRS80 • IBM**

A full line of software for business, games and education **up to 35% off!**

MUSE	KIS
VISCORP	STONEWARE
ONLINE	SYNERGISTIC
EDUWARE	HAYDEN
HOWARD	AND MANY MORE

### HARDWARE

**AMDEK • HAYES • MICROSOFT**

**FRANKLIN COMPUTER SYSTEM**

**ACE 1000 • \$1,795.00**

### DISKS

Maxell	Box of 10, 5 1/4", SS-DD	\$35.00
Verbatim	Box of 10, 5 1/4", SS-DD	\$29.00

### MONITORS

LE MONITORS	List	Our Price
9" Green	\$189.00	\$159.00
12" Green	\$199.00	\$169.00
ZENITH		
12" Green	\$179.00	\$129.00

Plus a full line of **AMDEK** Monitors

### PRINTERS

PAPER TIGER	List	Our Price
460G	\$1,094.00	\$950.00
560G	\$1,394.00	\$1,250.00
EPSON		
MX 70	\$449.00	\$395.00
MX 80FT	\$745.00	\$595.00
MX 100FT	\$945.00	\$795.00

**CALL FOR THIS MONTH'S SPECIAL!**

**1-800-835-2246 EXT. 211**

OR  
**702-459-4114**



5130 East Charleston Blvd.  
Suite 5M1  
Las Vegas, Nevada 89122



Phone orders welcome. Mail orders may send charge card number (include expiration date), cashiers check, money order or personal check (allow ten business days for personal or company checks to clear). Add \$3.00 for shipping, handling and insurance. Nevada residents add 5.75% sales tax. Please include phone number. All equipment is in factory cartons with manufacturer's warranty. Equipment subject to price change and availability. Call or write for price list.



**HYPERCARTRIDGE™**  
for ATARI® 400/800

**16K**

**\$39**

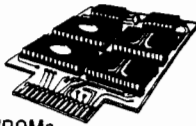

w/o EPROMs/ROMs

**FOR SOFTWARE DEVELOPERS  
AND HOBBYISTS!**

- extend memory of 16K RAM and 32K RAM computers
- create 16K cartridges easily with an EPROM programmer
- combine ATARI® BASIC ROMs with your own subroutines on ROM/EPROM
- eliminate need for disk drive and extra RAM for lengthy programs

**CONFIGURATIONS:**

- #1 Any combination of 4 2532 EPROMs/2332 ROMs
  - #2 Two ATARI ROMs and two 2532's (or 2332's)
- SPECIFY WITH ORDER

Also order:

2532 4K EPROMs \$7.50 each  
with cartridge order only

**CHAMELEON COMPUTING™**

Dept. of Physics & Astronomy  
Box 119-M  
Dickinson College  
Carlisle, PA 17013  
(717) 245-1717

Please add:  
\$1.50 shipping/handling  
PA residents add 6% sales tax  
**CHECK, MC, VISA**  
Quantity discounts available

Table 2 (continued)

Mnemonic	Data Size/CCR	Function	Comments
BTST	8, 32 CCR X N Z V C - - - - -	Test a Bit	The state of a bit in the destination is tested and the state of the bit is reflected in the Z bit.

Opword Format

15	14	13	12	11	10	9	8	7	6	5	4	3	2	1	0
0	0	0	0	0	Register	1	0	0	Effective Address Mode	Register					

Register

The bit number is specified in the data register specified by the register field. The effective address specifies the destination location. The following effective address modes cannot be used: 2, 12, 13, 14.\*

Opword Format

15	14	13	12	11	10	9	8	7	6	5	4	3	2	1	0
0	0	0	0	1	0	0	0	0	0	Effective Address Mode	Register				
											Bit number				

The effective address specifies the destination location and the bit number specifies the bit location. The following effective address modes cannot be used: 2, 12, 13, 14.\*

\*The addressing modes will be covered in future issues.



**Announcing  
THE GUIDE**

**A Complete Guide  
to the Apple Computer**

If You Own the Original  
**What's Where in the  
APPLE?**  
You Will Want  
**THE GUIDE**  
only \$9.95\*

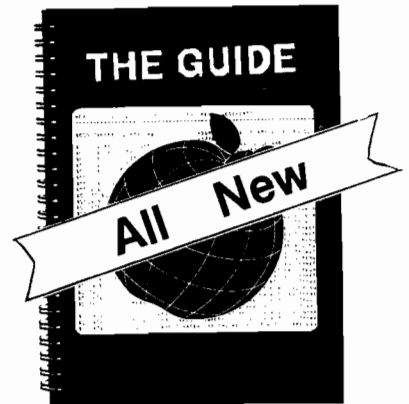

The Guide provides full explanatory text to lead you through the most complete Apple memory map ever published!

The Guide explains and demonstrates how to use the atlas and gazeteer published in the original volume!

\*Add \$2.00 shipping per book.  
MA residents add 5%.

MICRO makes it easy to order:  
Send check (payable to MICRO) to:

**MICRO INK**  
P.O. Box 6502 Chelmsford, MA 01824

Call our toll-free number:  
**1-800-345-8112**  
(In PA, 1-800-662-2444)

VISA and MasterCard accepted



## From Here To Atari

By Paul S. Swanson

This month's column covers technical literature available for Atari computers. The term technical, of course, means different things depending on your programming level of expertise.

For non-programmers who want to learn, there is one general book on the market that provides a good introduction to programming. This book, *Karel the Robot* by Richard E. Pattis [Wiley, 1981], was intended as an introduction to Pascal, but is well written as an introduction to almost any computer language.

For those who already know something about programming and own an Atari computer and a BASIC Language Cartridge, there are two good sources. One is *Atari BASIC* by Albrecht, Finkel, and Brown [Wiley, 1979], which is written to teach you how to program in BASIC. The *BASIC Reference Manual* from Atari outlines the available BASIC commands and has some handy reference tables. One table, labeled "Memory Locations," provides vectors, shadow locations, and hardware locations that you can PEEK or POKE for special actions. These two books come with the BASIC cartridge in a programmer's kit from Atari.

Your next step in acquiring literature from Atari is a reference book called *De Re Atari*, which was written by several Atari staff members and is available at most computer stores that carry the Atari. In addition to the features I listed above, this book also explains how Atari BASIC uses memory, then does the same for the resident operating system and disk operating system. Other topics include vertical blank interrupts, cassette operations, television artifacts, and the GTIA chip (if you aren't familiar with this chip you are in for a pleasant surprise).

In the middle of digesting *De Re Atari*, you will probably become interested in machine language. I know of no machine-language book available from Atari, but almost any book on the

6502 should work. I use *Programming the 6502* by Rodney Zaks [Sybex, 1978]. Another is Lance Leventhal's *6502 Assembly Language Programming*, [Osborne/McGraw-Hill, 1979].

There are other books available for Atari computers at the level of *De Re Atari*. *Your Atari Computer* by Poole, McNiff, and Cook [Osborne/McGraw-Hill, 1982], is a good example. It covers certain features of the Atari and its peripherals in more depth and is therefore a good supplement to *De Re Atari*.

For even more advanced programmers, Atari publishes the *Technical User Notes*, a combination of the *Operating System Manual* and the *Hardware Manual*. These are strictly reference books — don't look for long explanations. They are concise descriptions of all the different system features. BASIC, for example, is not even mentioned. The few examples are in machine language.

I have all the above-mentioned books within arm's reach of my Atari computer, as well as a few reference books concerning integrated circuits (I also experiment with my own electronic circuitry). The *Hardware Manual* contains all the wiring diagrams of the Atari computer (both the 400 and the 800), invaluable for interfacing.

### Talking to Other Computers

One question from a reader reminded me of a recent project I embarked upon. The question concerned moving data from an Apple to an Atari. I recently set up communication between my Atari and a 6502-based system I built from scratch. This allowed me to develop the 6502's operating system using an assembler on the Atari. I communicated to and from the Atari through game controller ports 3 and 4. Using one plug connected at game controller 4, I set up a serial communication through half of one of the two PIA bytes. The PIA can be directly accessed and programmed through hardware registers. A register named PBCTL (for Port B control) at location \$D303 (decimal 54019) allows you to set up game controller ports 3 and 4 as either input, output, or any combination on

the eight joystick pins. From BASIC, POKE 54019,56, then POKE 54017 with a bit map of which pins you want as input and which you want as output. For input, use a zero bit; for output use a one. Next, POKE 54019,60. The joystick pins on game controllers 3 and 4 are now set up the way the bit map specified.

The eight joystick pins are the top pins on each game controller jack excluding the far right pin on each. The Port B byte includes the eight pins on jacks 3 and 4. The lowest order bit is the top leftmost pin on jack 3; the highest order bit is the fourth pin from the left on the top row of jack 4.

If you are working on transmitting data from the Apple to the Atari, I have another suggestion that will help things run faster. The Apple clock runs at 1 MHz, but the Atari clock runs at about 1.79 MHz; therefore, the Atari can process information about 75% faster than the Apple. If you have conversions, use the Atari. To get the full advantage of the Atari's faster clock, write a zero to location \$D40E and another zero to location \$D400. Location \$D400 enables and disables the different types of direct memory access available. Location \$D40E enables and disables the non-maskable interrupts (except SYSTEM RESET). You will have no screen display after that. Write to \$D40E first because \$D400 is shadowed during the vertical blank interrupt. The zero in \$D40E will stop the shadowing and allow access directly to the hardware register. It also allows an easier method for undoing all that disabling. When you have written those two zeros out, run the conversion routine. When the conversion is done, just write a \$40 to location \$D40E to re-enable the vertical blank interrupt. The shadowing will re-enable the DMA by rewriting the original contents of location \$D400.

### In Conclusion

Future columns will be based on letters from readers. If you have any suggested topics or questions concerning the Atari, write me at 97 Jackson Street, Cambridge, MA 02140.

MICRO

# ARK COMPUTING

LOWERS THE BOOM  
ON HIGH PRICES

## SPECIALS

16K Ram Board	<b>\$79.95</b>
80 Column Board (Wiz-80)	<b>\$195.00</b>
Parallel Printer Interface (W/Cable) (compatible with Pascal, Basic, CP/M)	<b>\$59.95</b>
Z-80 Softcard	<b>\$259.95</b>
Joyport	<b>\$59.95</b>
ARK Special (includes Wiz-80, Lazer Keyboard Lower Case Plus)	<b>\$295.00</b>
On-Line Systems: General Manager	<b>\$99.95</b>
Diskettes w/hubring (10)	<b>\$19.95</b>
Hi-Res Secrets	<b>\$84.95</b>
Expediter II	<b>\$59.95</b>
The Dictionary	<b>\$69.95</b>
Microsoft 16K Ram Card	<b>\$99.95</b>
Time Zone	<b>\$69.95</b>
Lazer Keyboard Plus	<b>\$69.95</b>
Lazer Lower Case Plus	<b>\$44.95</b>
Lazer Lower Case Plus II	<b>\$19.95</b>
Anix 1.0	<b>\$34.95</b>
Lazer Pascal	<b>\$29.95</b>
Anix-Pac (Anix, Pascal, Sources)	<b>\$99.95</b>
Using 6502 Assembly Language	<b>\$14.95</b>
Datamost Joystick	<b>\$39.95</b>
Datamost Expandport	<b>\$49.95</b>

## GAMES

Softport Adventure (no graphics)	\$29.95/ <b>\$19.95</b>	Upper Reaches of Apshei	\$19.95/ <b>\$15.95</b>
#0 Mission Asteroids	\$19.95/ <b>\$14.95</b>	The Keys to Acheron	\$19.95/ <b>\$15.95</b>
#1 Mystery House	\$24.95/ <b>\$18.95</b>	Datestones of Ryn	\$19.95/ <b>\$15.95</b>
#2 Wizard & Princess	\$32.95/ <b>\$19.95</b>	Morlock's Tower	\$19.95/ <b>\$15.95</b>
#3 Cranston Manor	\$34.95/ <b>\$24.95</b>	Ricochet	\$24.95/ <b>\$19.95</b>
#4 Ulyesses & the Golden Fleece	\$34.95/ <b>\$24.95</b>	Starfleet Orion	\$24.95/ <b>\$19.95</b>
#5 Time Zone	\$99.95/ <b>\$69.95</b>	Invasion Orion	\$24.95/ <b>\$19.95</b>
Hi-res Cribbage	\$24.95/ <b>\$19.95</b>	The Dragon's Eye	\$24.95/ <b>\$19.95</b>
Hi-res Soccer	\$29.95/ <b>\$19.95</b>	Tues Morning Quarterback	\$29.95/ <b>\$21.95</b>
Hi-res Football	\$39.95/ <b>\$29.95</b>	Jabbertalky	\$29.95/ <b>\$21.95</b>
Sabotage	\$24.95/ <b>\$19.95</b>	Sorcerer of Siva	\$29.95/ <b>\$21.95</b>
Jawbreaker	\$29.95/ <b>\$19.95</b>	Rescue at Ridge	\$29.95/ <b>\$21.95</b>
Threshold	\$39.95/ <b>\$24.95</b>	Crush, Crumble, and Chomp	\$29.95/ <b>\$21.95</b>
Missile Defense	\$29.95/ <b>\$19.95</b>	Temple of Apshei	\$39.95/ <b>\$29.95</b>
Crossfire	\$29.95/ <b>\$19.95</b>	Hellfire Warrior	\$39.95/ <b>\$29.95</b>
Pegasus	\$29.95/ <b>\$19.95</b>	Star Warrior	\$39.95/ <b>\$29.95</b>
Warp Destroyer	\$29.95/ <b>\$21.95</b>	Hi-res golf	\$29.95/ <b>\$21.95</b>
Star Cruiser	\$24.95/ <b>\$19.95</b>	Race for Midnight	\$29.95/ <b>\$21.95</b>
Adventure	\$29.95/ <b>\$21.95</b>	Midnight Music	\$34.95/ <b>\$24.95</b>
Both Barnets	\$24.95/ <b>\$19.95</b>	Star Blazer	\$31.95/ <b>\$24.95</b>
Cyber Strike	\$39.95/ <b>\$29.95</b>	Apple Panic	\$29.95/ <b>\$19.95</b>
Phantoms Five	\$29.95/ <b>\$21.95</b>	Space Quark	\$29.95/ <b>\$19.95</b>
Space Eggs	\$29.95/ <b>\$19.95</b>	Red Alert	\$29.95/ <b>\$19.95</b>
Autobahn	\$29.95/ <b>\$21.95</b>	Track Attack	\$29.95/ <b>\$19.95</b>
Pulsar II	\$29.95/ <b>\$21.95</b>	Genetic Drift	\$29.95/ <b>\$19.95</b>
Orbitron	\$29.95/ <b>\$21.95</b>	Arcade Machine	\$44.95/ <b>\$29.95</b>
Gamma Goblins	\$29.95/ <b>\$19.95</b>	Raster Blaster	\$29.95/ <b>\$21.95</b>
Gorgon	\$39.95/ <b>\$29.95</b>	Trilogy of Games	\$29.95/ <b>\$21.95</b>
Sneakers	\$29.95/ <b>\$19.95</b>	Space Album	\$39.95/ <b>\$29.95</b>
EPOCH	\$34.95/ <b>\$24.95</b>	Fender Bender	\$24.95/ <b>\$19.95</b>
Cops & Robbers	\$34.95/ <b>\$24.95</b>	3-D Graphics	\$39.95/ <b>\$29.95</b>
Outpost	\$29.95/ <b>\$19.95</b>	Akalabeth	\$34.95/ <b>\$24.95</b>
Dark Forest	\$29.95/ <b>\$19.95</b>	Appoleids	\$29.95/ <b>\$21.95</b>
Beer Run	\$29.95/ <b>\$19.95</b>	Ultima	\$39.95/ <b>\$29.95</b>
Borg	\$29.95/ <b>\$19.95</b>	LA Land Monopoly	\$29.95/ <b>\$21.95</b>
Joy Port w/Joystick	\$74.95/ <b>\$59.95</b>	Hyperspace Wars	\$29.95/ <b>\$21.95</b>
Madron	\$34.95/ <b>\$24.95</b>	3-D Skiing	\$24.95/ <b>\$19.95</b>
Tweeps	\$29.95/ <b>\$19.95</b>	Torpedo Terror	\$24.95/ <b>\$19.95</b>
Computer Football	\$29.95/ <b>\$19.95</b>	Computer Bingo	\$24.95/ <b>\$19.95</b>
Wizardry	\$49.95/ <b>\$39.95</b>	Kaves Karkhan	\$49.95/ <b>\$34.95</b>
Galactic Attack	\$29.95/ <b>\$21.95</b>	Dragon Fire	\$49.95/ <b>\$34.95</b>
Minator	\$34.95/ <b>\$24.95</b>	Rings of Saturn	\$39.95/ <b>\$29.95</b>
Olympic Decathlon	\$29.95/ <b>\$21.95</b>	Alkemstone	\$39.95/ <b>\$29.95</b>
Three Mile Island	\$39.95/ <b>\$29.95</b>	Snake Attack	\$29.95/ <b>\$21.95</b>
ABM	\$24.95/ <b>\$19.95</b>	Casino	\$39.95/ <b>\$24.95</b>
Robot Wars	\$39.95/ <b>\$29.95</b>	Thief	\$29.95/ <b>\$21.95</b>
Global War	\$24.95/ <b>\$19.95</b>	County Fair	\$39.95/ <b>\$29.95</b>
Castle Wolfenstein	\$29.95/ <b>\$21.95</b>	Swashbuckler	\$24.95/ <b>\$19.95</b>
Falcons	\$29.95/ <b>\$21.95</b>	Firebird	\$29.95/ <b>\$19.95</b>
Suicide	\$29.95/ <b>\$21.95</b>	Russki Duck	\$34.95/ <b>\$25.95</b>
Grand Prix	\$29.95/ <b>\$21.95</b>	Honzon V	\$34.95/ <b>\$25.95</b>
The Best of Muse	\$39.95/ <b>\$29.95</b>	Sargon II	\$29.95/ <b>\$21.95</b>
Flight Simulator	\$33.50/ <b>\$26.95</b>	Reversal	\$34.95/ <b>\$25.95</b>
Dungeon Campaign	\$17.50/ <b>\$14.95</b>	Zork	\$39.95/ <b>\$29.95</b>
Odyssey	\$29.95/ <b>\$21.95</b>	Zork II	\$34.95/ <b>\$24.95</b>
Escape From Arcturus	\$24.95/ <b>\$19.95</b>	Pool 15	\$29.95/ <b>\$21.95</b>
Palace in Thunderland	\$24.95/ <b>\$19.95</b>	Shuffleboard	\$29.95/ <b>\$21.95</b>
MAD Venture	\$24.95/ <b>\$19.95</b>	Trick Shot	\$39.95/ <b>\$29.95</b>
Roach Motel	\$34.95/ <b>\$25.95</b>	Crossword Magic	\$49.95/ <b>\$39.95</b>
English SAT #1	\$29.95/ <b>\$21.95</b>	Master Type (Hi-res)	\$39.95/ <b>\$29.95</b>
U.S. Constitution	\$29.95/ <b>\$21.95</b>	Doglight	\$29.95/ <b>\$21.95</b>
		Crown of Arthain	\$34.95/ <b>\$26.95</b>

## HARDWARE

12" hi-res green display	\$285.00/ <b>\$159.95</b>
12" hi-res color display	\$430.00/ <b>\$349.95</b>
12" hi-res RGB color display	\$1095.00/ <b>\$885.95</b>
Apple Card II	\$389.00/ <b>\$329.00</b>
Apple Clock	\$280.00/ <b>\$195.95</b>
Supertaker S02000	\$199.00/ <b>\$149.95</b>
Romplus	\$155.00/ <b>\$124.95</b>
Romwriter	\$175.00/ <b>\$139.95</b>
Music System	\$395.00/ <b>\$295.95</b>
A/D-D/A	\$350.00/ <b>\$249.95</b>
Expansion Chassis (125v)	\$750.00/ <b>\$495.00</b>
CPS Multifunction Card	\$239.00/ <b>\$149.95</b>
RAM Plus #3 (32 RAM board w/16K installed)	\$189.00/ <b>\$139.95</b>
COPYROM	\$55.00/ <b>\$44.95</b>
Keyboard Filter ROM	\$55.00/ <b>\$44.95</b>
13 Key Keypad (new or old)	\$125.00/ <b>\$94.95</b>
Bar code reader	\$195.00/ <b>\$145.95</b>
Softkey (15-key user-defin)	\$150.00/ <b>\$119.95</b>
Asynchronous Serial	\$179.95/ <b>\$129.95</b>
Datamost Joystick	\$59.95/ <b>\$39.95</b>
Datamost Expandport	\$69.95/ <b>\$49.95</b>
Micromodem	\$379.00/ <b>\$289.00</b>
Smartmodem (RS-232)	\$279.00/ <b>\$199.00</b>
Lower Case #I (Rv 6 & earlier)	\$64.95/ <b>\$44.95</b>
Lower Case # II (Rv 7 & Ltr)	\$24.95/ <b>\$14.95</b>
Lower Case # III (Rv 7 & Ltr)	\$49.95/ <b>\$34.95</b>
Keyboard #Plus	\$99.95/ <b>\$89.95</b>
Character Set #Plus	\$24.95/ <b>\$19.95</b>
Sup R Term 80-col board	\$395.00/ <b>\$295.00</b>
Sup R Switcher (pw suppl)	\$295.00/ <b>\$195.00</b>
A35 35-track disk drive w/o controller	\$479.00/ <b>\$379.00</b>
A35 35-track disk drive w/ controller	\$579.00/ <b>\$449.00</b>
A40 40-track disk drive w/o controller	\$449.00/ <b>\$359.00</b>
A40 40-track disk drive w/ controller	\$549.00/ <b>\$449.00</b>
A70 70-track disk drive w/o controller	\$599.00/ <b>\$499.00</b>
A70 70-track disk drive w/ controller	\$699.00/ <b>\$599.00</b>

## BUSINESS SOFTWARE

Mail Label & Filing System	\$74.95/ <b>\$49.95</b>
Payroll	\$395.00/ <b>\$295.00</b>
General Ledger (w/payables)	\$495.00/ <b>\$395.00</b>
Home Money Minder	\$34.95/ <b>\$24.95</b>
The Mail Room	\$34.95/ <b>\$24.95</b>
CPA I General Ledger	\$249.95/ <b>\$189.95</b>
CPA II Accounts Receivable	\$249.95/ <b>\$189.95</b>
CPA III Accounts Payable	\$249.95/ <b>\$189.95</b>
CPA IV Payroll	\$249.95/ <b>\$189.95</b>
CPA V Property Manage	\$249.95/ <b>\$189.95</b>
The Home Accountant	\$74.95/ <b>\$54.95</b>
Word Star	\$375.00/ <b>\$195.00</b>
Supersort	\$200.00/ <b>\$124.95</b>
Mail Merger	\$125.00/ <b>\$79.95</b>
Data Star	\$300.00/ <b>\$195.00</b>
Spellstar	\$200.00/ <b>\$124.95</b>
Calc star	\$200.00/ <b>\$124.95</b>
Visicalc 3.3	\$250.00/ <b>\$179.95</b>
PFS (Personal Filing System)	\$125.00/ <b>\$89.95</b>
PFS Report	\$95.00/ <b>\$69.95</b>
The Correspondent	\$59.95/ <b>\$49.95</b>
Mailing List Database	\$49.95/ <b>\$39.95</b>
Higher Text II	\$39.95/ <b>\$29.95</b>
Directory Manager v2	\$29.95/ <b>\$21.95</b>
Real Estate Analysis Pgm	<b>30% OFF</b>
PIE WRITER	(call for details)
Easy Mover 40-column	\$49.95/ <b>\$39.95</b>
Easy Mailer 40-column	\$69.95/ <b>\$49.95</b>
Easy Writer 40-column	\$99.95/ <b>\$74.95</b>
Pro Easy Mailer	\$175.00/ <b>\$124.95</b>
Pro Easy Writer	\$249.95/ <b>\$179.95</b>
Super Scribe II	\$129.95/ <b>\$79.95</b>

## UTILITIES

Hi-Res Secrets (D. Fudge)	<b>\$124.95/\$84.95</b>
Super Shape Drg & Animate	\$34.95/ <b>\$24.95</b>
The Creative Tool Box	\$44.95/ <b>\$34.95</b>
AppleSoft Compiler	\$175.00/ <b>\$129.95</b>
Datadex	\$150.00/ <b>\$99.95</b>
Using 6502 Assembly Lang	\$19.95/ <b>\$14.95</b>
ANIX (UNIX-like Oper sys)	\$49.95/ <b>\$39.95</b>
Lazer Pascal	\$39.95/ <b>\$29.95</b>
DOSOURCE 3.3	\$39.95/ <b>\$24.95</b>
Painter Power	\$39.95/ <b>\$29.95</b>
The Voice	\$39.95/ <b>\$29.95</b>
E-Z Draw	\$49.95/ <b>\$39.95</b>
Pascal Graphics Editor	\$99.95/ <b>\$89.95</b>
ACE	\$39.95/ <b>\$29.95</b>
Apple-DOC	\$49.95/ <b>\$39.95</b>
List Master	\$39.95/ <b>\$29.95</b>
ASCII Express	\$79.95/ <b>\$59.95</b>
Z-Term Pro	\$99.95/ <b>\$89.95</b>
Z-Term Pro	\$149.95/ <b>\$99.95</b>
Speed Star	\$134.95/ <b>\$99.95</b>
On-Line	\$89.95/ <b>\$69.95</b>
DB Master	\$229.00/ <b>\$159.95</b>

## UTILITIES

LISA v2.5	\$79.95/ <b>\$59.95</b>
LISA Educational Pack	\$119.95/ <b>\$79.95</b>
Speed/ASM	\$39.95/ <b>\$29.95</b>
Expediter II	\$99.95/ <b>\$59.95</b>
Disk Organizer II	\$99.95/ <b>\$21.95</b>
AppleSoft Plus	\$24.95/ <b>\$19.95</b>
AppleSoft Optimizer	\$24.95/ <b>\$19.95</b>
Disk Recovery	\$29.95/ <b>\$21.95</b>
Multi-disk Catalog	\$24.95/ <b>\$19.95</b>
Back it up	\$59.95/ <b>\$39.95</b>
Image Printer	\$29.95/ <b>\$29.95</b>
Pascal Lower Case	\$24.95/ <b>\$19.95</b>
Dos Plus	\$24.95/ <b>\$19.95</b>
The Original Quick Loader	\$24.95/ <b>\$19.95</b>
Typing Tutor	\$195.00/ <b>\$139.95</b>
Fortran	\$125.00/ <b>\$89.95</b>
A.L.D.S	\$395.00/ <b>\$295.00</b>
Basic Compiler	\$750.00/ <b>\$495.00</b>
Cobol	\$175.00/ <b>\$129.95</b>
TASC	\$59.95/ <b>\$44.95</b>
Data Plot	\$99.00/ <b>\$69.95</b>
DB Utility Pack	\$99.00/ <b>\$69.95</b>

We accept: MASTERCARD, VISA (include card # and expiration date), CASHIER or CERTIFIED CHECKS, MONEY ORDERS, or PERSONAL CHECKS (Please allow 10 days to clear). Please add 3% for shipping & handling (minimum \$2.00). Foreign orders please add 10% for shipping & handling. We accept COD's (Please include \$2.00 COD charge). California residents add 6% sales tax. All equipment is subject to price change and availability without notice. All equipment is new & complete with manufacturer's warranty.

Apple is a registered trademark of APPLE COMPUTER INC.

YOUR SALVATION IN THE SEA OF INFLATION  
**ARK COMPUTING**

P.O. BOX 2025  
CORONA, CALIFORNIA 91720  
(714) 735-2250

# Discrete Event Simulation in Pascal

by Anita and Bill Walker

**This article explains some of the techniques used in simulating real-world situations on the computer. An example program involving a queue is presented.**

**Program Bank**  
requires:  
Pascal

## Introduction

What is computer simulation? Intuitively, we suggest that it is the act of causing a computer to imitate a real-world situation so that you can analyze the effects of changing portions of the environment in that situation. Ideally this process will be sufficiently accurate to allow you to make management decisions without performing experiments to test the idea. The Apollo moon-landing trips were extensively simulated before the first mission, providing valuable insight into possible difficulties without risking loss of hardware or personnel.

One method of providing answers to hypothetical questions in a simulation is to observe the situation in question for a specific interval and take notes. A less time-consuming method is to program the computer to emulate the situation and answer the questions for you. Although this process rarely gives exact answers, it is possible to use the computer to gain valuable insight. This tutorial discusses some of the techniques used in discrete event simulation. (Do not expect the results to be the gospel truth.) It also suggests a few tools that might be useful to the simulator and provides an example.

## How Do Discrete Simulations Work?

A simulation that emulates a physical system can be programmed for

the computer. Within this system are various events that occur at particular points in time and affect the physical system in predictable ways, often generating additional events. To emulate a physical system, you must first specify a list of possible events. This is a crucial part of the process and will be discussed later in more detail.

As the events are generated, they are placed in a line called the event list, which is maintained sequentially.

Think of the event list as being sorted according to increasing values of time. Suppose the list contains three different types of events. It is ordered according to time, not type, so it may be possible for several events of one type to occur before an event of another type occurs. Figure 1 is a flowchart of a typical control program and, in effect, oversees the simulation process.

After initialization, select an event from the event list and perform the ac-

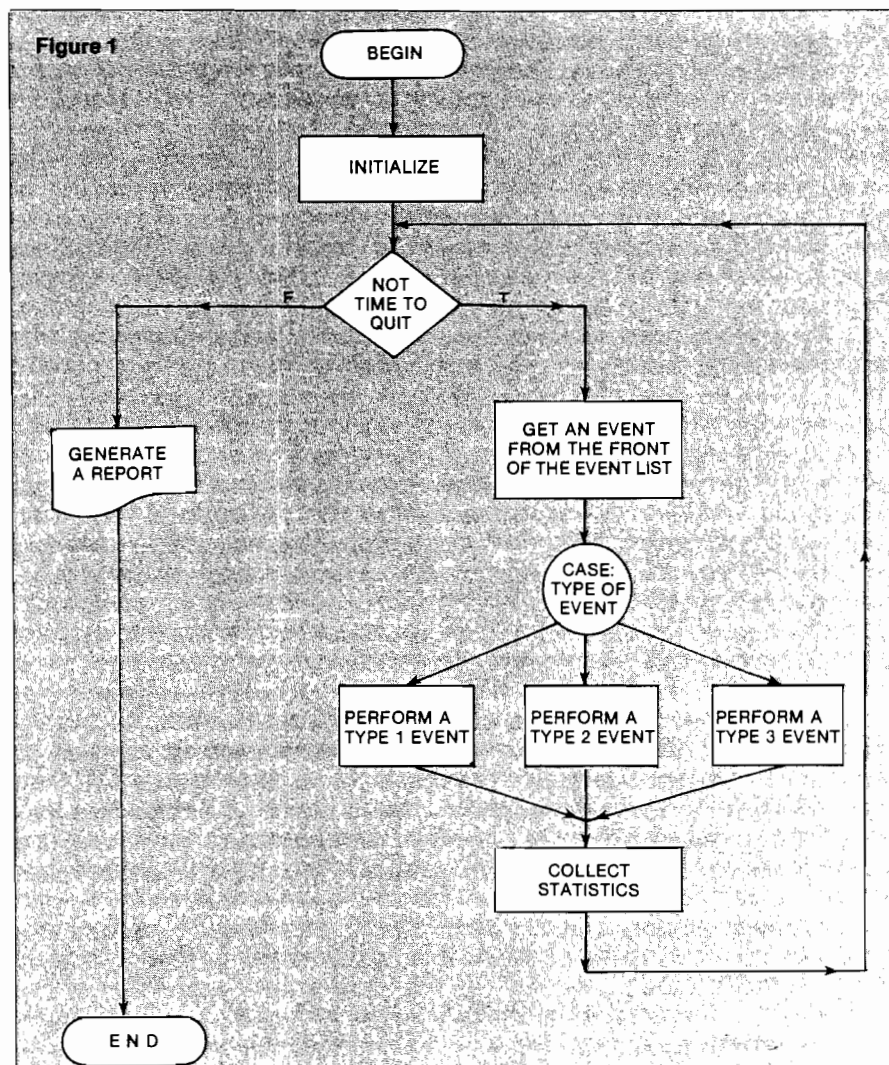

tions dictated by the type of event until the simulation is over. Keep notes on the effect of the actions. The actions you perform often generate more events that are added to the event list by order of increasing time. After the run is completed print the statistical results and conclude the program run.

We discuss each portion of this flowchart in detail and develop utility procedures that allow you to actually write a program based on figure 1.

### Tools for Simulation

To formulate a sample program you must first develop several tools to use in the discrete simulation program. This section explains two such tool packages: 1. managing the event list, keeping the events in increasing order of time, getting the next event from the list, and properly adding new events in the list; and 2. discussing various random (actually pseudo-random) number generators, emphasizing the generation of numbers on 8-bit machines (with the possibility of expanding the generators to run on other machines).

#### The Event-List Manager

The event-list manager consists of several procedures designed to handle the event list. Remember, the event list consists of a series of events kept in chronological order (for this example). If a new event is created with a scheduled time of occurrence, it must be placed properly among the other events already in the list. The important thing to remember is that when the new event is inserted into the list, the list still must be in chronological order.

You may insert events anywhere in the event list but, typically, events are removed from the list one at a time and from one end of the list only. In other words, when you reach the point for an event to occur, that event is removed from the front of the list and a procedure is executed to carry out the action dictated by that event.

In this discussion, we maintain a linked list, using pointers, which contains the events of a simulation in chronological order. Two procedures are necessary: SCHEDULE, which inserts an event into its proper place in the event list, and GETEVENT, which removes the next (front) event from the event list. To facilitate writing the procedures, we define an event as a Pascal record structure with three fields. One of the fields is linked to the next event,

and the other two fields contain the time the event occurred and the type of event. Although it is not necessary to do so, we use several global variables to implement our event-list manager. One of these is HEAD, which is a pointer that returns NIL if the event list contains no events.

The procedure SCHEDULE (see listing 1) schedules events properly into the event list. Procedure GETEVENT is a procedure that returns the type of event and its scheduled time of occurrence at the front of the list as well as deletes that event from the event list. We make use of the event type in the control program. It is possible to rewrite these procedures as functions, but we prefer the method chosen.

#### Random Number Generators

The function RND (see listing 1) generates a sequence of pseudo-random numbers on most 8-bit machines that is distributed almost uniformly between the values of 0 and 1. Pseudo random means the numbers are not truly random numbers, but depend in some manner on each other. If you start with the same value for SEED each time, you will get the same sequence of numbers. However, *distribution* of the numbers is more important than true randomness. Uniform distribution means that a number is likely to fall equally anywhere between 0 and 1. The function (unfortunately) produces a numerical sequence that repeats itself every 64 numbers. If you are using a longer word length for your machine, you can arrange the function to produce longer sequences before it repeats itself.

The function RNEXP is used to generate numbers with an exponential distribution whose average is "U". This distribution is often more useful in simulation than the uniform distribution of RND. Since the function RNEXP depends on the function RND, the exponential distribution generator will also repeat after a short sequence. If you have a random-number generator available for your machine, the function RNEXP can be used directly.

#### Other Tools

Other necessary tools include procedures to accomplish an action demanded by an event to keep statistics on the state of the system after each event, and to report the final results of the simulation. These tools are exceedingly sensitive to the nature of the

actual system being simulated and, as a rule, cannot be generalized.

### How to Write a Simulation Program

Although each simulation program is different, it is possible to make a few general statements. First, an event is something that causes the state of a system (a set of data) to change. Note that we are talking about discrete simulations only. For example, consider the case of a line of people waiting for service at a bank teller's window. At any given point in time the system state is completely described by counting the number of people in the line. The state changes when someone joins the line or when someone departs. You might describe the state of the system by saying "There are ... people in the line." Proper events cause the state to change. In this case those events are identified as ARRIVE and DEPART.

It is important to specify the proper events for a simulation when writing a useful program. If an event is hidden or overlooked, you may get meaningless results. If too many events are specified, programming may be awkward or even impossible.

After you have chosen the events for a simulation you must identify the characteristics (parameters) you want to measure. Parameters are part of the state of the system and should be things that are affected by the events. A typical parameter for the bank window example would be a measurement of the average length of the customer line. This length is affected by two events only — ARRIVE and DEPART — and the length does not change until one of these events takes place.

In the flowchart of figure 1 the procedure COLLECT STATISTICS keeps running totals of the state variables (parameters) measured. Consequently, design of this procedure depends upon what those state variables are.

Another portion of the program called an event procedure accomplishes the action(s) demanded by a particular event. In the above example you might use such a procedure to add a person to the end of a line (corresponding to the event ARRIVE) or remove a person from the front of the line (corresponding to the event DEPART).

Finally, the report section should present a summary of the statistics that you collect with the procedure COLLECT STATISTICS.

(Text continued on page 25)



## Program Bank

```

program bank (input,output);
uses transcend,applestuff;
{ this is an APPLE statement. Other computers
  can probably omit this statement entirely }
const starttime = 0;
      endtime = 14400; { 4 hours in seconds }
      uariv = 50.0; { average interarrival time }
      userv = 40.0; { average service time }
type ptr = fevent;
      event = record
          eventtype : char;
          eventtime : integer;
          link : ptr;
      end;
var kindofevent : char;
    departcount, arrivecount, queuelength,
    maxqueuelength, time, oldtime,
    oldqueuelength, eventcounter : integer;
    timequeuelength : real;
    head, p, oldptr, q : ptr;
function rnd (list: integer): real;
var x : real;
begin
    { This function should be replaced by
      an appropriate function for your system.
      It's purpose is to generate uniformly
      distributed random numbers between 0 and 1 }
    x := random;
    { if we want the first list, access the generator
      a second time to try to remove some bias }
    if list = 1 then x := random;
    { be sure not to generate 0 as a number, since
      the function RNEXP below would blow up }
    if x = 0 then x := x + 1;
    rnd := x / 32767;
end;
function rnext(list:integer; u : real) : real;
begin
    { This is a pseudo-random number generator for
      generating exponentially distributed pseudo-
      random numbers with an average value of u.
      It depends greatly on function RND above, and
      if RND repeats its sequence of numbers fairly
      often, so will this function }
    { this function selects random numbers from
      two different lists which are generated by
      RND above }
    rnext := (-u)*ln(rnd(list));
end;
procedure getevent (var typeofevent : char; var newtime : integer);
{ this procedure gets the next event from the
  event list }
begin
    if head <> nil then
        begin
            typeofevent := headf.eventtype;
            newtime := headf.eventtime;
            head := headf.link;
        end;
end;
procedure schedule (typeofevent : char; newtime : integer);
{ this procedure enters a new event into the event list }
var quit : boolean;
begin
    { first we create the new event and initialize it }
    new(q);
    qf.link := nil;
    qf.eventtime := newtime;
    qf.eventtype := typeofevent;
    { now we place the new event in its proper place
      in the event list }
    if head = nil then head := q
    else
        begin
            if (newtime < headf.eventtime) then
                begin
                    qf.link := head;
                    head := q;
                end

```

## Program Bank (continued)

```

        else
            begin
                p := head;
                quit := false;
                while ((pf.eventtime <= newtime) and
                    (quit = false)) do
                    begin
                        if pf.link = nil then
                            begin
                                pf.link := q;
                                quit := true;
                            end
                        else
                            begin
                                oldptr := p;
                                p := pf.link;
                            end;
                    end; { of the while }
                if quit <> true then
                    begin
                        oldptrf.link := q;
                        qf.link := p;
                    end;
                end;
            end; { of schedule }
procedure initialize;
var newtime : integer;
begin
    departcount := 0;
    arrivecount := 0;
    queuelength := 0;
    maxqueuelength := 0;
    time := 0;
    oldtime := 0;
    oldqueuelength := 0;
    eventcounter := 0;
    timequeuelength := 0.0;
    head := nil;
    p := nil;
    oldptr := nil;
    q := nil;
    { schedule the initial event }
    newtime := time + round (rnext(1,uariv));
    schedule ('a',newtime);
    { randomize the random number generator—
      this is how to do it on the APPLE }
    randomize;
end;
procedure statistics;
{ this collects the statistics }
begin
    { if you want LOTS of output, you can
      remove the comment symbols around the
      following: }
    { if kindofevent = 'a' then write ('arrival ')
      else write ('departure '); }
    writeln ( ' at ',time, ' seconds'); }
    { update the event counters }
    eventcounter := eventcounter + 1;
    if kindofevent = 'a' then arrivecount := arrivecount + 1
    else departcount := departcount + 1;
    { update the queue length }
    if maxqueuelength < queuelength then
        maxqueuelength := queuelength;
    { update the time averaged queue length }
    timequeuelength := timequeuelength +
        (time - oldtime) * oldqueuelength;
    { update the accumulation stuff }
    oldqueuelength := queuelength;
    oldtime := time;
end; { of statistics }
procedure makereport;
{ this procedure reports all of the results }

```

(Continued on next page)

## Program Bank (continued)

```

begin
writeln (chr(7),chr(7));
writeln ;
writeln (' the simulation was run for ',
(endtime-starttime)/60 :10:2, ' minutes ');
writeln;
writeln ('there were ',eventcounter,' events with ');
writeln (' ',arrivecount,' arrivals, and ');
writeln (' ',departcount,' departures.');
```

{ in a more elaborate program, the following two procedures may actually handle a queue, instead of simply updating a counter }

```

procedure addtoqueue;
{ this adds people to the waiting line }
begin
  queuelength := queuelength + 1;
end;
procedure popqueue;
{ this deletes people from the waiting line }
begin
  if queuelength > 0 then queuelength := queuelength - 1;
end;
{ the following procedures are the 'event procedures ' }
procedure service;
{ this procedure, while not properly an 'event', provides service to a customer if it is needed. It is called by the events ARRIVE and DEPART }
var newtime : integer;
```

## Program Bank (continued)

```

begin
  if queuelength <> 0 then
  begin
    schedule ('d',newtime);
  end;
end;
procedure arrive;
var newtime : integer;
begin
  addtoqueue;
  newtime := round(rnexp(1,uariv)) + time;
  schedule ('a',newtime);
  if queuelength = 1 then service;
end;
procedure depart;
begin
  popqueue;
  service;
end;
begin { main program }
  initialize;
  while time <= endtime do
  begin
    getevent (kindofevent,time);
    case kindofevent of
      'a' : arrive;
      'd' : depart;
    end;
    statistics;
  end;
  makereport;
end.
```

## EVER WONDER HOW YOUR APPLE II WORKS?

**QUICKTRACE will show you! And it can show you WHY when it doesn't!**

This relocatable program traces and displays the actual machine operations, while it is running and without interfering with those operations. Look at these FEATURES:

**Single-Step mode** displays the last instruction, next instruction, registers, flags, stack contents, and six user-definable memory locations.

**Trace mode** gives a running display of the Single-Step information and can be made to stop upon encountering any of nine user-definable conditions.

**Background mode** permits tracing with no display until it is desired. Debugged routines run at near normal speed until one of the stopping conditions is met, which causes the program to return to Single-Step.

**QUICKTRACE** allows changes to the stack, registers, stopping conditions, addresses to be displayed, and output destinations for all this information. All this can be done in Single-Step mode while running.

**Two optional display formats** can show a sequence of operations at once. Usually, the information is given in four lines at the bottom of the screen.

**QUICKTRACE** is completely transparent to the program being traced. It will not interfere with the stack, program, or I/O.

**QUICKTRACE** is relocatable to any free part of memory. Its output can be sent to any slot or to the screen.

**QUICKTRACE** is completely compatible with programs using Applesoft and Integer BASICs, graphics, and DOS. (Time dependent DOS operations can be bypassed.) It will display the graphics on the screen while **QUICKTRACE** is alive.

**QUICKTRACE** is a beautiful way to show the incredibly complex sequence of operations that a computer goes through in executing a program.

**Price: \$50**

QUICKTRACE was written by John Rogers. QUICKTRACE is a trademark of Anthro-Digital, Inc.

QUICKTRACE requires 3548 (\$E00) bytes (14 pages) of memory and some knowledge of machine language programming. It will run on any Apple II or Apple II Plus computer and can be loaded from disk or tape. It is supplied on disk with DOS 3.3.

## QUICKTRACE DEBUGGER

	Last address		Disassembly	
Last Instruction	FF69-	A9 AA	LDA	##AA
		Top seven bytes of stack		Processor codes
Stack	ST=7C	A1 32 D5 43 D4 C1	NV-BDIZC	0000=4C
	Accumulator	X reg.	Y reg.	Stack pointer
Contents	A=AA	X=98	Y=25	SP=F2 PS=10110001 []=DD
			Disassembly	Reference address
Next Instruction	FF6B-	85 33	STA	#33 [#0033]

**Anthro-Digital, Inc.**  
 P.O. Box 1385  
 Pittsfield, MA 01202  
 413-448-8278

In the following section we simulate the classic bank line problem. The example is instructive and provides an opportunity to apply several of the concepts we have discussed.

### The Example

In this example we make several assumptions: 1. the waiting line is a queue (no one butts in, no one leaves early), service takes place at the front of the line only, and new arrivals join the end; 2. arrivals occur with an exponential distribution interarrival time of 50 seconds; and 3. the time it takes for the teller to serve a customer is also exponentially distributed with an average time of 40 seconds.

The next step is to measure the state variables (parameters); in this case, the average length of the line and the longest length of the line.

Listing 1 provides a simulation of the bank-line situation. The program can be adapted to most single-server queue systems, although it probably will be necessary to change the characteristics of the pseudo-random number generators to suit other physical situations. The exponential distributions used here are not unrealistic for this situation. The listing is written in UCSD Pascal on an Apple II. (Note: there are many languages available for simulation programs. We chose Pascal as the most commonly available language suitable to the hobbyist.) With other versions of Pascal you could take advantage of the dispose function of standard Pascal. The program runs to completion in about three minutes for a four-hour simulation, with a typical event count exceeding 500.

### How to Make Use of the Simulation Program

Run the program many times so the random-number generators provide different sequences of events each time. (This is usually accomplished simply by changing the SEED of the function.) Each run of the program provides a number that represents the maximum length of the queue during that run. If you run the program ten times, you have ten different numbers. An average of these numbers gives you meaningful data about what to expect from the actual physical situation. The results of a single simulation run, however, are unlikely to provide much information.

Figure 2

Trial Number	Average Queue Length	Maximum Queue Length	Number of Arrivals	Number of Departures
1	2.78938	13	281	280
2	4.14340	17	301	301
3	2.81646	15	273	271
4	2.34562	10	277	271
5	3.67563	13	259	258
6	1.74604	8	264	261
7	3.17368	15	282	276
8	2.41681	12	259	258
9	6.13910	22	314	308
10	3.58667	19	261	260
11	2.83958	10	279	275
12	1.71257	7	261	260
13	4.14527	15	294	293
14	3.32611	14	285	282
15	7.24937	19	331	315
16	1.93847	9	264	262
17	3.52042	12	312	309
18	7.25556	22	305	304
19	3.92014	10	304	304
20	4.29167	16	297	296
21	3.45194	12	283	277
22	4.97257	16	302	299
23	2.65333	10	282	279
24	3.04583	10	302	299
25	7.77750	20	322	316
26	8.19340	25	303	293
27	2.57618	12	286	285
28	3.48049	15	293	291
29	3.67924	14	292	284
30	12.89966	26	333	322
31	4.99736	21	303	299
32	2.65465	9	264	263
33	2.34090	8	301	296
34	2.53410	10	274	270
35	3.77437	13	293	288
36	2.14736	13	278	277
37	2.81681	12	292	290
38	7.78674	31	317	294
39	2.68153	11	273	268
40	3.36868	14	278	277
<b>Total Average</b>	<b>4.02</b>	<b>31</b>	<b>Average Maximum Length</b>	<b>14.50</b>

A powerful theorem in mathematics, Central Limit Theorem, allows you to draw some meaningful conclusions by examining the averages of several program runs. The usual procedure is to form a confidence interval for the parameter that you choose to measure. We have presented a summary for the example problem in figure 2.

### Mathematical Analysis

The programmer should be aware that the results obtained from the

discrete simulation process are at most good approximations to the results obtained in the real situation itself. It is gratifying, however, to solve the simulation problem using analytic methods and to discover just how accurate these approximations are. Analytic solutions are not always obtainable and hence the need for simulations.

In the following pages we use mathematics to investigate the bank-line simulation. You should become familiar with the notations and ter-

minology used. *Queuing time* is the total time that a single customer is in the system. This time begins when the customer arrives at the end of the line and stops when he leaves the line after being served. *Waiting time* is the time between arrival and service. Use the following notations:

$T_a$  = average lapse of time between the arrivals of two consecutive customers

$\lambda$  = average arrival rate of the customers, given by the formula  
 $\lambda = 1 / T_a$

$T_s$  = average time needed to serve one customer

$\mu$  = average service rate for each customer, given by  
 $\mu = 1 / T_s$

$I$  = intensity of customer traffic, given by any of the following:  
 $I = T_s / T_a = \lambda T_s = \lambda / \mu$

$\rho$  = the amount of time a single bank teller needs to serve a customer (usually a decimal or a percentage)

The following averages are useful when certain distributions and probabilities are difficult to obtain:

$L_q$  = the average number of customers in the system (length of the queue)

$L_w$  = the average number of customers in the waiting line

$T_q$  = the average queuing time

$T_w$  = the average waiting time

In this example the values which determine  $T_a$  and  $T_s$  are *exponentially distributed*. [Consider the exponential curve  $y = e^x$ . Each service time  $t$  achieved in the problem lies on the exponential curve. Hence, every  $t$  is shown as  $t = e^x$  for some number  $x$  ( $x$  real). The typical time needed to serve one customer ( $T_s$ ) is obtained by averaging a large number of individual service times of less than 40 seconds with a small number of service times of more than 40 seconds. Thus, the average service time ( $T_s = 40$  seconds) is represented by the horizontal line  $t = 40$ . The average time between the arrival of two consecutive customers ( $T_a = 50$  seconds) is represented by the line  $t = 50$ .

Given all the above, you can evaluate the desired quantities and compare them to your computer results. You can see immediately that  $T_a = 50$  seconds and  $T_s = 40$  seconds (given quantities) lead to the results:

$\lambda = 1/50$ , which means that on the average one person arrives every 50 seconds, and

$\mu = 1/40$ , which means that on the

**Figure 3: Analytic versus Computed Results**

AVERAGE QUEUE LENGTH INDICATED BY LISTING ONE	4.02
AVERAGE QUEUE LENGTH COMPUTED ANALYTICALLY	4.00
PERCENTAGE DIFFERENCE	1/2 %

average one person is served every 40 seconds, and  
 $I = 40/50$ .

If  $I$  is less than 1, that indicates the bank teller is serving faster than the customers are arriving. A traffic intensity greater than 1 indicates the teller is serving slower than the customers are arriving.

We define  $\rho$  in the following way: a long period of time is represented by  $T_L$ , the number of customers arriving at the system by  $n = T_L / T_a$ , and the total service time by  $nT_s$ . Therefore, the time that the bank teller is busy is  $\rho = nT_s / T_L = nT_s / nT_a = T_s / T_a$ . Here  $\rho = 40/50 = 4/5$ . The teller is busy 4/5 of the time ( $T_L$ ).

The formula for the quantity  $L_q$  is  
 $L_q = (\lambda^2 b_2) / 2(1 - \rho) + \rho$  where  
 $b_n = n! T_s^n$

If you evaluate this expression you learn that  $L_q = 4.0$  for this simulation. You also have  $L_w = L_q - \rho$ , which calculates as  $L_w = 3.2$ . Similarly,  $T_q = [\lambda b_2 / 2(1 - \rho)] + b_1$  evaluates to  $T_q = 200$  seconds.  $T_w$  is given by  $T_w = \lambda b_2 / 2(1 - \rho)$ , and evaluates to 160 seconds. Note that the average queuing time is equal to the average waiting time plus the average time needed to serve one customer.

Figure 3 compares the results of the analytic investigation with the numbers obtained from the computer simulation. They seem to agree with each other in a reasonable fashion.

## Conclusions

Although the science of simulation is rather complicated, we are able to draw some meaningful results from discrete-event simulation techniques. Hopefully, you will study these techniques further. If you do not, perhaps this article will serve to give you a speaking acquaintance with some of the procedures involved.

## Suggested Reading

1. Fishman, G.S., "Concepts and Methods in Discrete Event Digital Simulation," John Wiley & Sons, New York, NY, 1973.
2. Gorney, Len, "Queuing Theory," *BYTE*, Vol. 4, #4 & #5, 1979.
3. Jensen, K. and Wirth, N., *Pascal User Manual and Report*, Springer-Verlag, New York, NY, 1974.
4. Kiviat, P.J., Villaneuva, R., and H. Markowitz, "The SIMSCRIPT II Programming Language," Prentice Hall, Englewood Cliffs, NJ, 1969.
5. Knuth, D.E., "The Art of Computer Programming, Vol 2: Semi-Numerical Algorithms," Addison-Wesley, Reading, MA, 1969.
6. Lewis, T.G. and Smith, M.Z., *Applying Data Structures*, Houghton Mifflin Co., Boston, MA, 1976.
7. Payne, James A., "Introduction to Simulation: Programming Techniques and Methods of Analysis," unpublished notes, copyright by J.A. Payne, 1979.
8. Schriber, T.J., "Simulation Using GPSS," John Wiley & Sons, New York, NY, 1974.
9. Wirth, Niklaus, *Algorithms + Data Structures = Programs*, Prentice-hall, Englewood Cliffs, NJ, 1976.

Bill Walker is an assistant professor of electrical engineering and computer science at the University of Oklahoma. He has a B.S. from West Texas State University and an M.S. and Ph.D. in mathematics from Texas Tech University. Anita is a teaching assistant and Karcher Fellow at the University of Oklahoma. She has a B.A. in German and a B.S. in mathematics from SMU, and an M.A. in mathematics from the University of Oklahoma. She is currently pursuing her Ph.D. in mathematics. You may contact the Walkers at Box 2806, Norman, OK 73070.

# Lyc0 Computer Marketing & Consultants

TO ORDER  
CALL US

TOLL FREE 800-233-8760  
In PA 1-717-398-4079

## ATARI SPECIALS

810 Disk Drive ... \$429.00  
32K RAM ..... \$ 79.00  
400 32K RAM ... \$179.00

# 800 48K... \$539.00

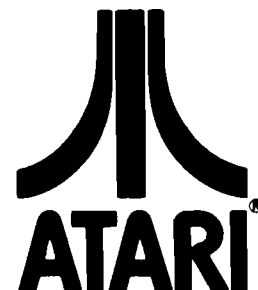

A Warner Communications Company

### PERCOM : In Stock

Single Drive ..... CALL  
Dual Drive ..... CALL  
(Read all Atari Disks)

## PRINTERS

Okidata 82A ..... \$479.00  
Okidata 83A ..... \$719.00  
Okidata 84 ..... \$1089.00  
Citoh ..... CALL  
Prowriter I ..... \$499.00  
Prowriter II ..... CALL  
SMITH CORONA TP-1 ..... \$625.00  
NEC ..... CALL  
(Interfacing Available)

### JOYSTICKS : In Stock

Atari CX-40 ..... \$18.00  
LeStick ..... \$34.00  
Wico Command Control ..... \$24.00  
WICO RED BALL ..... \$27.95  
STICK STAND ..... \$ 6.75

### Computer Covers

800 ..... \$6.99  
400 ..... \$6.99  
810 ..... \$6.99

### DISKETTES : In Stock

Maxell MD1 ... (10) ..... \$34.00  
Maxell MD2 ... (10) ..... \$44.00  
Elephant ... (10) ..... \$21.00

### THIRD PARTY SOFTWARE ATARI PROGRAM EXCHANGE

Eastern Front 1941 ..... \$25.50  
Avalanche ..... \$15.50  
Outlaw/Howitzer ..... \$15.50  
Dog Daze ..... \$15.50  
Wizard of War ..... \$31.00  
Gorf ..... \$31.00  
Frogger ..... \$26.00

### BUSINESS SOFTWARE : In Stock

Atari Word Processing ..... \$109.00  
Letter Perfect ..... \$129.00  
Test Wizard ..... \$ 89.00  
Datasm/65 ..... \$125.00  
Interisp ..... \$125.00

Monkey Wrench ..... \$ 42.00  
Utility Disk ..... \$ 36.50  
Ultimate Renumber ..... \$ 15.50

## ATARI HARDWARE

410 Cassette Recorder ..... \$75.00  
825 Printer ..... \$585.00  
830 Phone Modem ..... \$149.00  
850 Interface ..... \$164.00

### PACKAGES

CX481 Entertainer ..... \$69.00  
CX482 Educator ..... \$125.00  
CX483 Programmer ..... \$49.00  
CX484 Communicator ..... \$325.00

### SOFTWARE

CXL4012 MISSILE COMMAND ..... \$28.75  
CXL4013 ASTEROID ..... \$28.75  
CXL4020 CENTIPEDE ..... \$32.75  
CXL4022 PACMAN ..... \$32.75  
CXL4011 STAR RAIDER ..... \$34.75  
CXL4004 BASKETBALL ..... \$26.75  
CXL4006 SUPER BREAKOUT ..... \$28.75  
CXL4008 SPACE INVADER ..... \$28.75  
CX8130 CAVERNS OF MARS ..... \$31.75  
CX4108 HANGMAN ..... \$12.75  
CX4102 KINGDOM ..... \$12.75  
CX4112 STATES & CAPITALS ..... \$12.75  
CX4114 EUROPEAN COUNTRIES ..... \$12.75  
CX4109 GRAPHIT ..... \$16.75  
CX4121 ENERGY CZAR ..... \$12.75  
CX4123 SCRAM ..... \$19.75  
CX4101 PROGRAMMING I ..... \$19.75  
CX4106 PROGRAMMING II ..... \$22.75  
CX4117 PROGRAMMING III ..... \$22.75  
CXL4015 TELELINK ..... \$21.75  
CX4119 FRENCH ..... \$39.75  
CX4118 GERMAN ..... \$39.75  
CX4120 SPANISH ..... \$39.75  
CX4120 SPANISH ..... \$39.75  
CXL4007 MUSIC COMPOSER ..... \$33.75  
CXL4002 ATARI BASIC ..... \$45.75  
CX8126 MICROSOFT BASIC ..... \$65.75  
CXL4003 ASSEMBLER EDITOR ..... \$45.75  
CX8126 MACROASSEMBLER ..... \$69.75  
CXL4018 PILOT HOME ..... \$65.75  
CX405 PILOT EDUCATOR ..... \$99.75  
CX415 HOME FILING MANAGER \$41.75  
CX414 BOOKKEEPER ..... \$119.75

### NEW RELEASES

CHOP LIFTER ..... \$27.75  
APPLE PANIC ..... \$23.75  
PREPPIE ..... \$19.95

## THIRD PARTY SOFTWARE

for atari 800 or 400  
K-BYTE

KRAZY SHOOTOUT ..... \$35.00  
K-DOS ..... \$65.00  
K-STAR PATROL ..... \$37.75  
K-RAZY ANTICS ..... \$37.75  
K-RAZY KRITTERS ..... \$37.75  
Q-BALL JOYSTICK KIT ..... \$6.75

### AUTOMATED SIMULATIONS

Star Warrior ..... \$28.00  
Crush, Crumble & Chomp ..... \$23.00

WE CARRY MANY OTHER THIRD PARTY PRODUCTS  
YOU CAN CALL FOR PRICES ON AND ASK FOR  
YOUR FREE ATARI PRODUCT CATALOG.



VIC-20 ..... \$189.00

VIC1530 DATASSETTE ..... \$67.00  
VIC1540 DISK DRIVE ..... \$499.00  
VIC1515 PRINTER ..... \$355.00  
VIC1210 3K RAM ..... \$35.00  
VIC1110 8K RAM ..... \$52.00  
VIC1211A SUPER EXPANDER ..... \$53.00

### VIC-20 SOFTWARE

VIC1212 PROGRAMMER AID ..... \$45.00  
VIC1213 VICMON ..... \$45.00  
VIC1906 SUPER ALIEN ..... \$23.00  
VIC1914 ADVENTURE  
LAND ADVENTURE ..... \$35.00  
VIC1915 PRIVATE COVE  
ADVENTURE ..... \$35.00  
VIC1916 MISSION IMPOSSIBLE ..... \$35.00  
VIC1917 THE COUNT ADVENTURE ..... \$35.00  
VIC1919 SARGON II CHESS ..... \$35.00

### THIRD PARTY SOFTWARE

ALIEN BLITZ ..... \$21.00  
Omega Race ..... \$35.00  
Gorf ..... \$32.00  
16K RAM/ROM ..... \$99.00  
AMOK ..... \$21.00  
SUPER HANGMAN ..... \$16.00  
SPIDERS OF MARS ..... \$45.00



POLICY



In-Stock items shipped within 24 hours of order  
Personal checks require four weeks clearance  
before shipping. PA residents add sales tax.  
All products subject to availability and price  
change. Add 4 % for Mastercard and Visa.

TO ORDER  
CALL TOLL FREE  
800-233-8760

In PA 1-717-398-4079  
or send order to  
Lyc0 Computer  
P.O. Box 5088  
Jersey Shore, PA 17740



# Doing Time on the 6809

by Jim Schreier

**Calculating time is simple, but requires special attention when manipulated by a BASIC program. Here are two ways to add time using TSC's XBASIC.**

**Doing Time**  
requires:

BASIC with string functions

Pennies automatically add up to dollars, but seconds refuse to add up to minutes. If Thomas Jefferson had planned our way of telling time, the following programs would have been unnecessary. Telling time is confused just enough to need special handling in your BASIC programs.

Adding seconds, minutes, and hours may be done with string manipulations (see program A), or by using a simple formula (program B). The formula approach is faster and applies to almost any BASIC. The string approach uses TSC XBASIC's INSTR command, which searches for a substring within the main string. As such, program A would be limited to more advanced BASICs.

The object of each approach is to add similar time units, subtract the next higher full unit, leave the remainder, and increment the next highest full unit. So 91 seconds would be reported as 1 minute and 31 seconds.

Each approach is presented as a usable program. You may adapt the program to work as a subroutine, or keep it as a handy time adder. I have found the programs useful in adding the lengths of video disk movies and multi-

record stereo sets. (If *The Godfather* runs 171 minutes and *The Godfather II* runs 200 minutes, dare I try to watch both in one evening?)

## Program A

Although manipulating strings to add time may be the long way home, it does demonstrate the "scenic route." The idea is to locate the decimal point once the total number of seconds have been divided by the constant 60 (line 120). If no decimal point occurs (tested in line 130), the program prints out the results and concludes. Line 140 uses the INSTR (IN STRING) command to locate the position of the decimal point, allowing the necessary string

## Program A

```

10 REM TIMESTR.BAS (Time String)
20 PRINT CHR$(12):PRINT
30 H%=60:W%=1:P$=""
40 REM Obtain input
50 INPUT "How many items to add",A%
60 FOR X%=1 TO A%
70 PRINT "Enter item";X%
80 INPUT B
90 T=T+B
100 NEXT X%
110 REM Calculate number of hours and minutes
120 H$=STR$(T/H%)
130 IF T/H%=INT(T/H%) THEN 180
140 I%=INSTR(W%,H$,P$)
150 MN$=RIGHT$(H$, (LEN(H$)-I%)+W%)
160 H$=LEFT$(H$,I%-W%)
170 MN=INT(VAL(MN$)*H%+.5)
180 REM Print out results
190 IF T < H% THEN H$="Zero"
200 PRINT:PRINT
210 PRINT "Total Time: ";H$;
    " Hours and ";MN;" Minutes"
220 END

```

maneuvering (lines 150-160). The results are printed as hours and minutes and the program concludes.

## Program B

The formula approach is less complex. Hours, minutes, and seconds must be entered in strict order. To enter 91 seconds, use "0,0,91". This program is more extensive than the one used for program A. It reports the total entered times as seconds, minutes, hours, and days.

Line 250 is a representative example for the calculations. The total seconds, when divided by the constant 60, gives the number of minutes. When the number of minutes are multiplied by 60 and subtracted from the total seconds, the remaining seconds become available. The newly calculated minutes are then added to the total minutes and the process is repeated to calculate hours and days.

Each program used control "L" — CHR\$(12) — to clear the CRT and home up the cursor. This should be adjusted to meet your requirements. Both programs set some variables and constants to integer by adding a percent sign [A%]. If your BASIC does not support integers, leave the percent signs out of the listings.

Jim Schreier has been a computer enthusiast since 1977. His articles have appeared in a number of magazines, and he has lectured about computers throughout the western United States. Contact Mr. Schreier in Phoenix, AZ 85040.

**Program B**

```

10 REM TIMEFORM.BAS (Time Formula)
20 REM Copyright (c) 1982 by Jim Schreier
30 REM This Basic program caculates time from hours, minutes and seconds
40 REM Clear screen and home up cursor is Control L. Set to your terminal.
50 CL$=CHR$(12)
60 REM Set program constants
70 ME%=100:C%=60:C1%=24
80 PRINT CL$
90 PRINT TAB(26);'TIME CACULATIONS''
100 PRINT:PRINT
110 INPUT 'Please enter the number of items'',NI%
120 IF NI% < 1 OR NI% > ME% THEN 130 ELSE 170
130 PRINT
140 IF NI% < 1 THEN PRINT ' ' > Entry out of range. Lower limit is 1 ...':GOTO 160
150 IF NI% > ME% THEN PRINT ' ' > Entry out of range. Upper limit is'';ME%;'...'
160 PRINT:GOTO 110
170 REM Obtain input
180 PRINT:PRINT
190 FOR A%=1 TO NI%
200 INPUT 'Enter Hours, Minutes and Seconds, (H,M,S)'';H%,M%,S%
210 TH%=TH%+H%:TM%=TM%+M%:TS%=TS%+S%
220 NEXT A%
230 REM Caculate seconds into minutes and seconds
240 IF TS%=0 OR TS% < C%-1 THEN 260
250 B1%=TS%/C%:TS%=TS%-(B1%*C%):TM%=TM%+B1%
260 REM Caculate minutes into hours and minutes
270 IF TM%=0 OR TM% < C%-1 THEN 290
280 B2%=TM%/C%:TM%=TM%-(B2%*C%):TH%=TH%+B2%
290 REM Caculate hours into days and hours
300 IF TH%=0 OR TH% < C1%-1 THEN 320
310 B3%=TH%/C1%:TH%=TH%-(B3%*C1%):TH%=TH%+B3%
320 REM Report time as Days, Hours, Minutes and Seconds
330 PRINT CL$:PRINT
340 PRINT TAB(5);'DAYS';TAB(25);'HOURS';TAB(45);'MINUTES';TAB(65);'SECONDS''
350 FOR X%=1 TO 67:PRINT TAB(5);'-'':NEXT X%
360 PRINT
370 PRINT TAB(5);B3%;TAB(25);TH%;TAB(45);TM%;TAB(65);TS%
380 END
    
```

MICRO

**STATISTICS**

PURE AND SIMPLE



*Human Systems Dynamics programs offer you flexibility, accuracy, and ease of use. You can purchase from the HSD statistics specialists with complete confidence. Any program that doesn't suit your needs can be returned within 10 days for full refund.*

NEW

**STATS PLUS \$200.00**

*Complete General Statistics Package  
Research Data Base Management  
Design and Restructure Your Files  
Count, Search, Sort, Review/Edit  
Add, Delete, Merge Files  
Compute Data Fields, Create Subfiles  
Interface with other HSD programs  
Produce Hi Res bargraphs, plots  
1-5 way Crosstabulation  
Descriptive Statistics for all Fields  
Chi-Square, Fisher Exact, Signed Ranks  
Mann-Whitney, Kruskal-Wallis, Rank Sum  
Friedman Anova by Ranks  
10 Data Transformations  
Frequency Distribution  
Correlation Matrix, 2 way Anova  
r, Rho, Tau, Partial Correlation  
3 Variable Regression, 3 t-Tests*

**ANOVA II \$150.00**

*Complete Analysis of Variance Package  
Analysis of Covariance, Randomized Designs  
Repeated measures Designs, Split Plot Designs  
1 to 5 Factors, 2 to 12 Levels Per Factor  
Equal N or Unequal N, Anova Table  
Descriptive Statistics, Marginal Means  
Cell Sums of Squares, Data File Creation  
Data Review/Edit, Data Transformations  
File Combinations, All Interactions Tested  
High Resolution Mean Plots, Bargraphs*

**HSD REGRESS \$99.95**

*Complete Multiple Regression Analysis  
Up to 25 Variables, 300 Cases/Variable  
Correlation Matrices, Descriptive Statistics  
Predicted & Residual Scores, File Creation  
Regression on Any Subset of Variables  
Regression on Any Order of Variables  
Hi-Res Scatterplot & Residual Plot  
Keyboard or Disk Data Input  
Case x Case Variable x Variable Input*

**Apple II, 48K 1 or 2 Disk Drives  
3.3. DOS, ROM Applesoft**

Call (213) 993-8536 to Order

or Write:

**HUMAN SYSTEMS DYNAMICS**  
9249 Reseda Blvd., Suite 107  
Northridge, CA 91324



**70 INCOME TAX PROGRAMS**  
(For Filing by April 15, 1983)  
**For APPLE II/II\* (DOS 3.3, 16-Sector)**

**FEATURES:—**

1. Menu Driven.
2. 70+ Tax Programs.
3. Basic; Unlocked; Listable.
4. Name/SS No./IFS carried over.
5. Inputs can be checked.
6. Inputs can be changed.
7. I.R.S. approved REVPROC format.
8. Prints entire Form/Schedule.
9. Calculates Taxes, etc.
10. In 3.3 DOS, 16-Sector.
11. Fast calculations.
12. Use GREENBAR in triplicate — don't change paper all season!
13. Our 4th Year in Tax Programs.
14. We back up our Programs!

Helpful programs to calculate and print the many Tax Forms and Schedules. Ideal for the Tax Preparer, C.P.A. and Individuals. For just \$24.75 per disk, post-paid (in 3.3 DOS; 16-Sector disks).

Programs are designed for easy-use, with check-points to correct parts as needed. Results on screen for checking before printing.

In all, there are more than 70 individual Tax Programs. These include Form 1040, 1040A, 1040EZ, 1120, 1120S, 1041 and 1065. Also Schedules A, B, C, D, E, F, G, R, RP and SE. And, Forms 1116, 2106, 2119, 2210, 2440, 3468, 3903, 4255, 4562, 4797, 4835, 4972, 5695, 6251 and 6252.

And, we have a disk we call "THE TAX PREPARER'S HELPER" which has programs for INCOME STATEMENTS, RENTAL STATEMENTS, SUPPORTING STATEMENTS, IRA, ACRS, 1040/ES, ADD W-2's and PRINT W-2's.

TRY ONE DISK AND SEE FOR YOURSELF. ONLY \$24.75 POSTPAID.

First disk is AP#1, and includes Form 1040 and Schedules A, B, C, D and G. \$24.75 POSTPAID.

**Write:—**

**GOOTH TAX PROGRAMS**

931 So. Bemiston • St. Louis, Mo. 63105



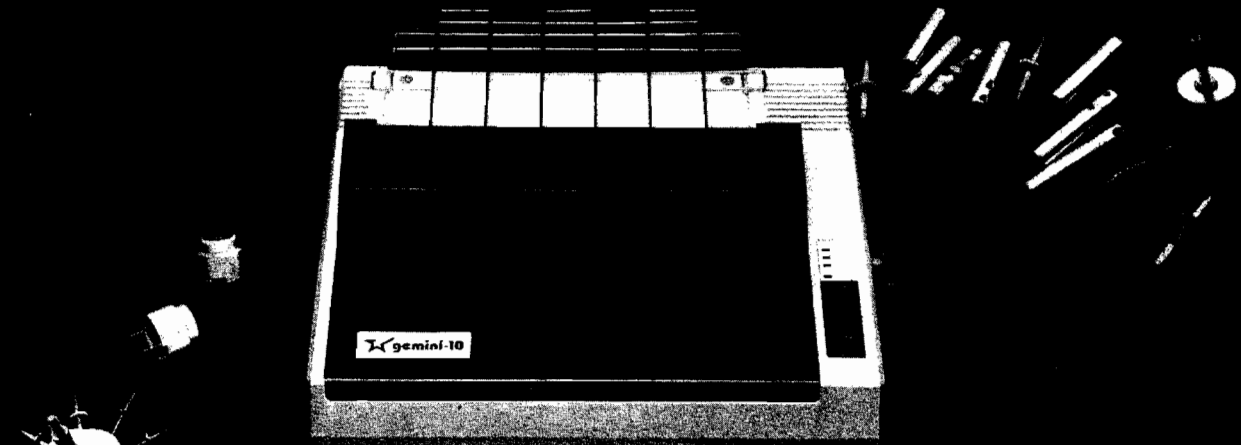

## GEMINI— FOR PRINTER VALUE THAT'S OUT OF THIS WORLD

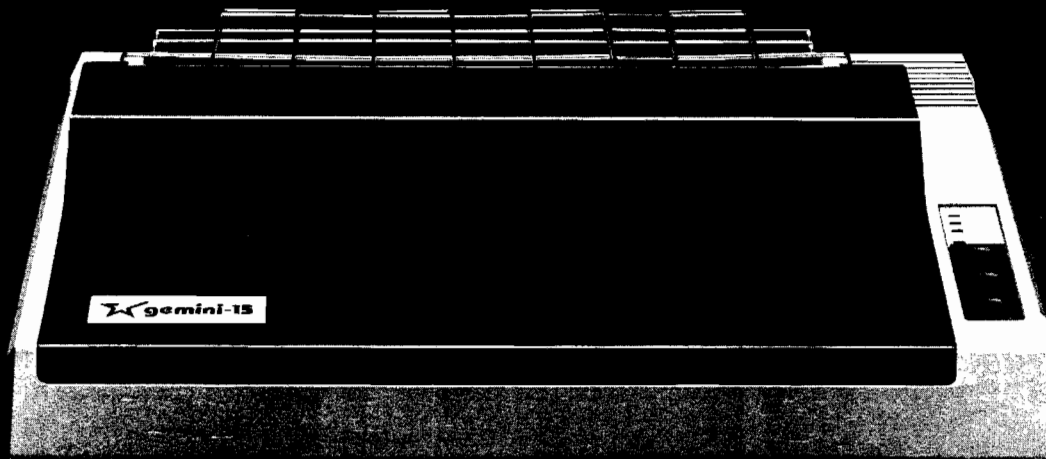

Over thirty years of down-to-earth experience as a precision parts manufacturer has enabled Star to produce the Gemini series of dot matrix printers—a stellar combination of printer quality, flexibility, and reliability. And for a list price of nearly 25% less than the best selling competitor.

The Gemini 10 has a 10" carriage and the Gemini 15 a 15½" carriage. Plus, the Gemini 15 has the added capability of a bottom paper feed. In both models, Gemini quality means a print speed of 100 cps, high-resolution bit image and block graphics, and extra fast forms feed.

Gemini's flexibility is embodied in its diverse specialized printing capabilities such as super/sub script, underlining, back-spacing, double strike mode and emphasized print mode. Another extraordinary standard

feature is a 2.3K buffer. An additional 4K is optional. That's twice the memory of leading, comparable printers. And Gemini is compatible with most software packages that support the leading printers.

Gemini reliability is more than just a promise. It's as concrete as a 180 day warranty (90 days for ribbon and print head), a mean time between failure rate of 5 million lines, a print head life of over 100 million characters, and a 100% duty cycle that allows the Gemini to print continuously. Plus, prompt, nationwide service is readily available.

So if you're looking for an incredibly high-quality, low-cost printer that's out of this world, look to the manufacturer with its feet on the ground—Star and the Gemini 10, Gemini 15 dot matrix printers.

**star**  
MICRONICS • INC  
MAKING A NAME FOR OURSELVES

1120 Empire Central Place, Suite 216, Dallas, TX 75247  
For more information, please call Bob Hazzard, Vice President, at (214) 631-8560.

## Listing 1

```

10 REM * Program 'ROCKET 1'
20 REM * Copyright (C) 1982
30 REM *
40 REM * Determines flight performance of model rockets
50 REM *
60 REM * Altitude at burnout in meters
70 REM * Velocity at burnout in meters/second
80 REM * Coast time and Total flight time in seconds
90 REM * Maximum altitude in meters
100 REM *
110 GØ = 9.80665 : RØ = 1.22557 : LN = 100
120 DEF FNA(X) = (1-2.2556913 E-5*X) + 4.256116
130 DEF FNB(X) = .5*(SQR(ABS(X))+X/SQR(ABS(X)))
140 REM *
150 CL$ = CHR$(11) + CHR$(24) : REM Clear Screen
155 PRINT CL$ : PRINT TAB(5); 'Program Rocket 1': PRINT
160 PRINT : INPUT 'Launch site altitude (Meters) ' ;H1
170 PRINT : INPUT 'Launch site temperature (Deg F) ' ;K1
190 PRINT : INPUT 'Thrust duration (Seconds) ' ;T1
200 PRINT : INPUT 'Total impulse (Newton-seconds) ' ;I1
210 PRINT : INPUT 'Initial mass (Grams) ' ;M1
220 PRINT : INPUT 'Propellant mass (Grams) ' ;M2
230 PRINT : INPUT 'Frontal diameter (mm) ' ;G1
240 PRINT : INPUT 'Drag coefficient ' ;G2
250 REM *
260 REM * Convert mass to kilograms and diameter to square meters
270 M1 = .001 * M1 : M2 = .001 * M2 : G1 = PI * G1 * G1 / 4E6
280 REM *
290 REM * Compensate for launch site altitude and temperature
300 R1 = RØ * FNA(H1) / (1 + (K1 - 59) / 518.67)
310 REM *
320 REM * Determine analytic solution
330 F1 = I1 / T1 : M3 = (M1 - M2 / 2) : K2 = .5 * R1 * G1 * G2
340 A = M3 * GØ : B = T1 * FNB(K2 * (F1 - A)) / M3 : C = EXP(B)
350 D = EXP(-B) : E = .5 * (C+D) : F = (C-D) / (C+D)
360 X1 = (M3 / K2) * LOG(E) : V1 = F * FNB((F1-A) / K2) : M3 = M1 - M2
370 A = M3 * GØ : T2 = FNB(M3 / (K2 * GØ)) * ATN(V1 * FNB(K2 / A))
380 X2 = (M3 / (2 * K2)) * LOG(K2 * V1 * V1 / A + 1)
390 T3 = T1 + T2 : X3 = X1 + X2
400 REM *
410 REM * Print results
420 PRINT CL$ : PRINT : PRINT TAB(5); 'Burnout altitude (Meters) ' ;TAB(5Ø); X1
430 PRINT : PRINT TAB(5); 'Burnout velocity (Meters/second) ' ;TAB(5Ø); V1
440 PRINT : PRINT TAB(5); 'Coast time (Seconds) ' ;TAB(5Ø); T2
450 PRINT : PRINT TAB(5); 'Total flight time (Seconds) ' ;TAB(5Ø); T3
460 PRINT : PRINT TAB(5); 'Maximum altitude (Meters) ' ;TAB(5Ø); X3
470 REM *
480 REM * Request another selection
490 PRINT : INPUT 'Another selection (Y/N) ' ;A$: IF A$ = 'N'THEN 530
500 PRINT : INPUT 'Another launch site (Y/N) ' ;A$: IF A$ = 'Y'THEN 160
510 PRINT : INPUT 'Another rocket engine (Y/N) ' ;A$: IF A$ = 'Y'THEN 190
520 PRINT : INPUT 'Different mass or drag (Y/N) ' ;A$: IF A$ = 'Y'THEN 210
530 PRINT CL$ : END
    
```

The user responds with "Y" to compute the flight performance of a model rocket with different mass or drag characteristics.

If another selection is made, the program will again execute the prompts necessary for the new selection. If the user answers "YES" to the prompt "ANOTHER SELECTION" but does not actually make a different selection, the program will stop after cycling through all the selection questions.

### Program Output

ROCKET1 outputs the model rocket altitude performance in units of the metric system. The burnout altitude and the maximum altitude are printed in meters and the burnout velocity is printed in meters per second. Coast time and total flight time are printed in seconds.

For users who want to see other

variables used in the software, "R1" is the launch site density in kilograms per cubic meters. The variable "X2" is the coast altitude increment in meters and "K2" is the variable  $\frac{1}{2}\rho C_d A$  in the units of kilograms per meter. "F1" is the average thrust of the model rocket engine in newtons.

### Technical Discussion

ROCKET1 first converts the lift-off and propellant masses to kilograms and determines the cross-sectional area of the model rocket in square meters. The atmospheric density at the launch site is then computed as a function of the launch site altitude and temperature.

The burnout altitude and velocity are computed with the following equations:

$$X_{bo} = \frac{m}{k} \ln[\cosh[td/m \sqrt{k(F - mg)}]]$$

$$V_{bo} = \sqrt{\frac{F - mg}{k}} \tanh[td/m \sqrt{k(F - mg)}]$$

where,

- m = average mass = lift-off mass — (propellant mass/2)
- k =  $\frac{1}{2}\rho C_d A$
- $\rho$  = atmospheric density
- Cd = drag coefficient
- A = cross-sectional area
- F = average thrust = total impulse / thrust duration
- td = thrust duration

The altitude gained during the coast flight and the coast time are determined using the next set of equations:

$$X_c = \frac{m}{2k} \ln[kV_{bo}^2/mg + 1]$$

$$t_c = \frac{m}{kg} \operatorname{atan}[V_{bo} \sqrt{k/mg}]$$

where,

- m = burnout mass = lift-off mass — propellant mass
- g = acceleration of gravity

The maximum altitude and total flight time are given by these equations:

$$X = X_{bo} + X_c$$

$$T = t_d + t_c$$

### References

1. G.K. Mandell, G.J. Caporaso, and W.P. Bengen, "Topics in Advanced Model Rocketry," MIT Press, 1971.
2. "Altitude Prediction Charts," Estes Industries Technical Report TR-10, 1971.
3. "Aerodynamic Drag of Model Rockets," Estes Industries Technical Report TR-11, 1970.
4. D. Malewicki, "Model Rocket Altitude Performance," Centuri Engineering Company Technical Information Report TIR-100, 1968.

---

David Eagle is an aerospace engineer with an undergraduate and graduate degree from the University of Michigan. He presently works at Lear-Siegler, Inc., in Grand Rapids, MI, on projects which involve the most fuel-efficient way to fly airplanes. You may contact Mr. Eagle at 3759 76th St. SW, Byron Center, MI 49315

# ANNOUNCING **ElectroScreen™** the Superior Alternative to the Traditional Alphanumeric Terminals

**only \$595**

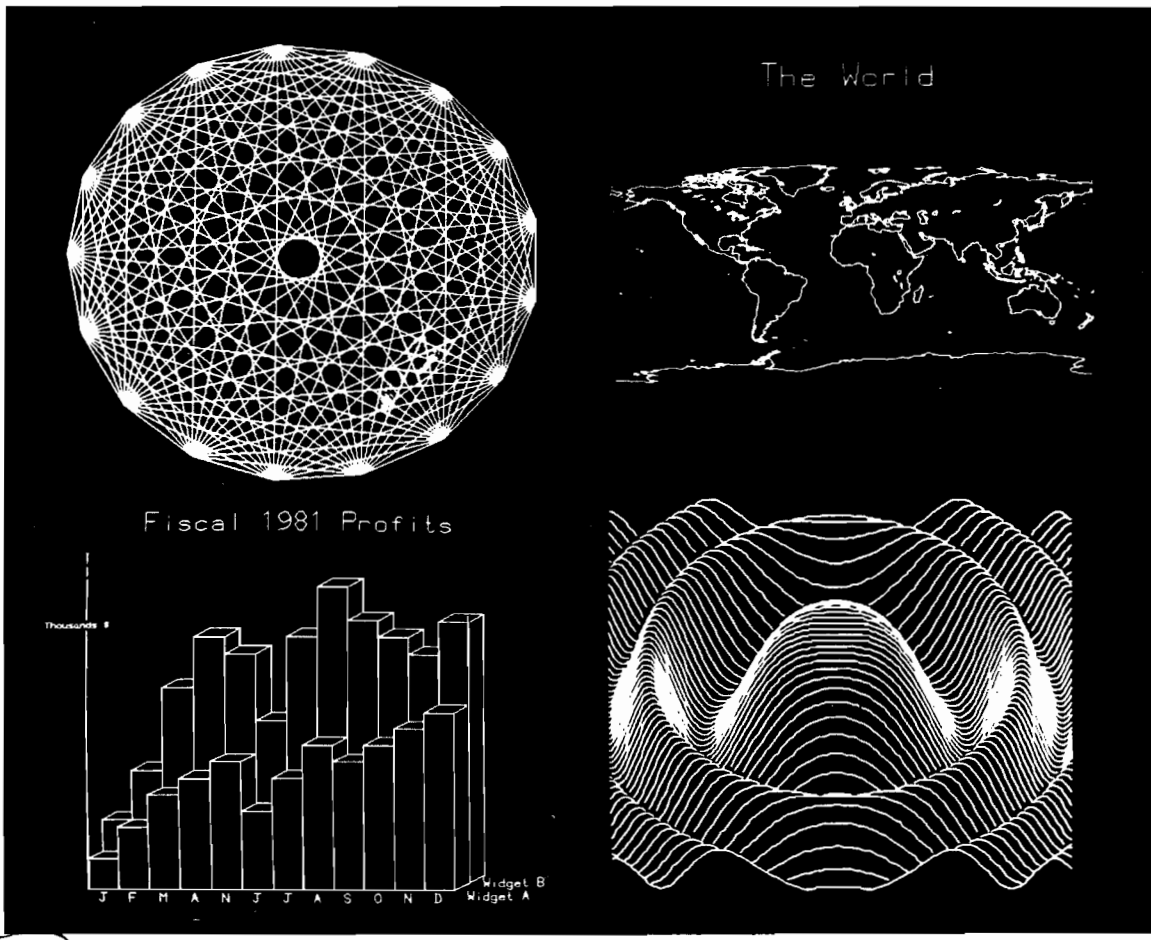

**RESET** **The ElectroScreen™ Intelligent Graphics Board Features:**

**Graphics**

- 512 x 480 resolution bit-mapped display
- Interleaved memory access — fast, snow-free updates

**Intelligence**

- 6809 on-board mpu
- 6K on-board firmware
- STD syntax high level graphics command set
- Removes host graphics software burden
- Flexible text and graphics integration
- Multiple character sizes 3, 15
- User programs can be run on-board

**Terminal**

- Terminal emulation on power-up
- 83 characters by 48 lines display
- Easy switching among user-defined character sets
- Fast hardware scrolling

**Additional Features**

- SS-50C and SS-64 compatible board
- Board communicates with host through parallel latches
- Composite and TTL level video output
- 8 channel 8 bit A/D converter
- Board occupies 4 address bytes

**See your dealer today!**

The ElectroScreen manual is available for \$10. credited toward purchase of the board.

The ElectroScreen has a 90 day warranty from purchase date.  
Dealers, please contact us for our special introductory package.



**Privac Inc** (703) 671-3900  
3711 S. George Mason Dr., Falls Church, Va. 22041



# FIRST THINGS FIRST. LEARN ALL ABOUT IT

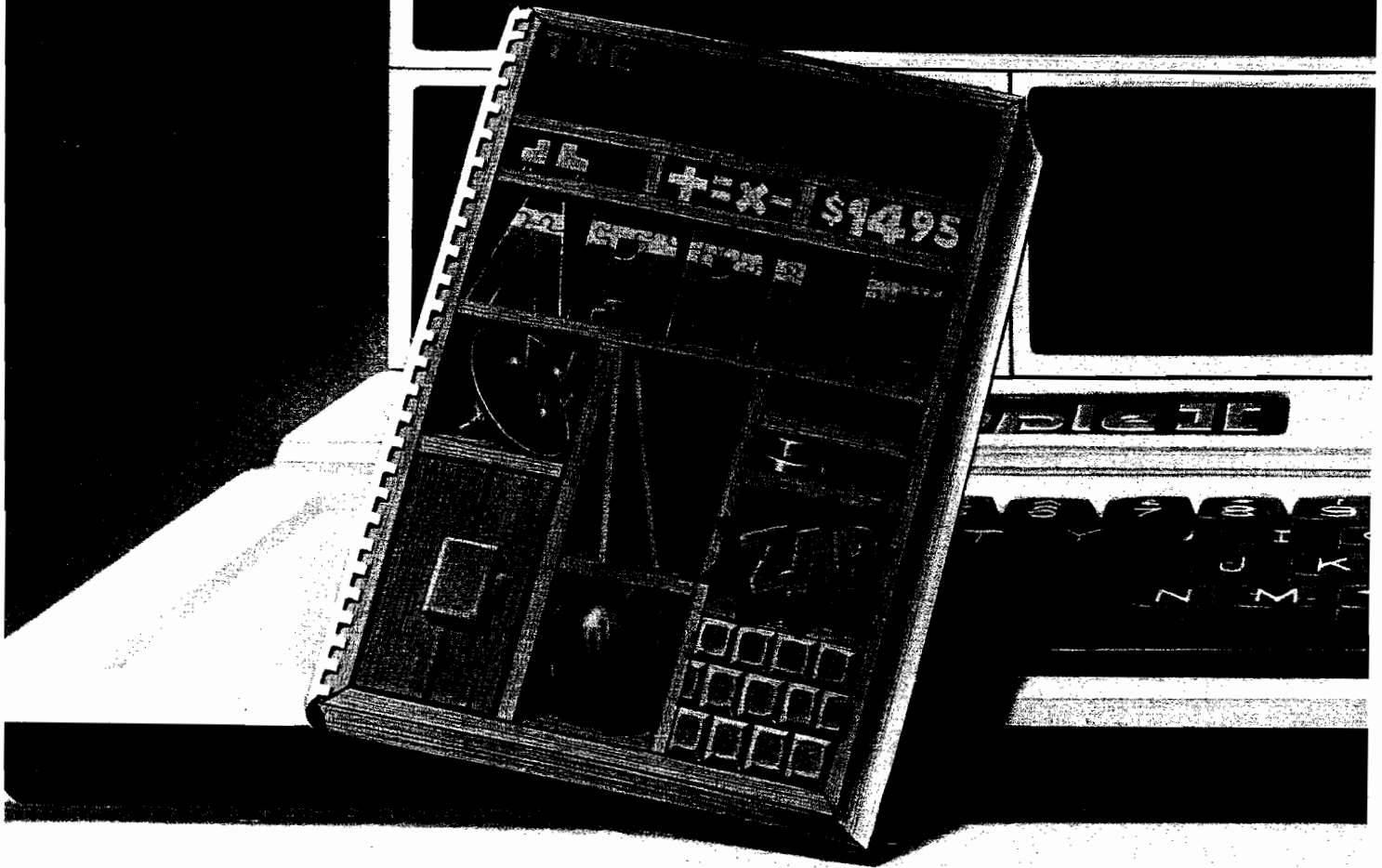

When you don't know the first thing about your new Apple II\* you need a friendly, cheerful, easy going teacher at your side. And the ELEMENTARY APPLE is just that kind of book.

It sweeps away the confusion—explains your Apple in everyday language—shows you how to hook it up, how to use the keyboard and work on the screen.

Gently and carefully it gives you an understanding of all the things your Apple can do. And then, it even shows how easy it is for anyone to write a simple program—provides common sense answers about graphics, utility programs, and the how and why of word processors, business programs and hardware like printers.

Yes, there's a lot of information. But, not one chapter one word is dull or difficult to follow or complicated. Prove yourself. Visit your computer store. Open the ELEMENTARY APPLE. Read a page of the introduction, then flip it open anywhere and read a paragraph or so. You'll find it's as understandable, as helpful and as marvelous as we say.

If you, or a member of your family, is an Apple beginner this is the book you need. It'll teach you everything you want to know, in the way you want to learn.

Only \$14.95. At computer and book stores, or:

 **DATAMOST** INC

9748 Cozycroft Ave., Chatsworth, CA 91311. (213) 709-120

VISA/MASTERCARD accepted. \$2.00 shipping/handling charge.  
(California residents add 6½% sales tax)

\*Apple II is a trademark of Apple Computers, Inc.

# Sun and Moon on the APPLE

by Svend Ostrup

**This Applesoft program produces a high-resolution graphic simulation of the apparent orbiting of the sun and moon around Earth as well as of the phases of the moon. It also predicts solar and lunar eclipses.**

**Sun and Moon**  
requires:  
48K Apple

The astronomy program listed simulates the apparent rotation of the sun and moon around Earth, as well as the phases of the moon day by day, beginning at a starting date chosen by the user. The locations of the ascending and descending nodes of the moon and of the moon's perigee are also shown. High-resolution page 1 shows all the above simultaneously with the current date and the moon's elongation. The program also predicts eclipses or the possibility of eclipses.

The material in this program is based on information provided by my son, Gert Ostrup, an amateur astronomer, and is published as an example of collaboration between novices in different fields — in this case astronomy and programming.

The program is straightforward and presents no difficulties. Some explanations, however, might be of value for the user to get full benefit from the program. Let us start looking at the firmament.

Type in the program and RUN. You will be informed that you can: 1. stop running the program at any date by pressing S [stop]; 2. re-start by pressing SPACE; 3. get a prompt for a new starting date by pressing M; and 4. exit the program by pressing ESC. You should be aware that nothing will happen until

the program has finished drawing the phase of the moon for the day in question, so some patience is required.

You will now be prompted to input a starting date (note the sequence: day, month, year). Try 28, 12, 1981. The program then draws a reference circle of dots spaced 10 degrees apart, marks the center (which is the location of Earth) and the 3 and 9 o'clock locations. The starting date soon appears and the sun and moon and three other objects (see below) are drawn inside the reference circle. Next the moon is drawn in its correct phase to the right of the reference circle. Meanwhile, the elongation of the moon (angular longitudinal distance between sun and moon in degrees) is printed. After a pause, the program goes on to the next day.

Let the program run briefly. When you reach 03-01 1982 press S and wait for the program to stop so you can take a closer look at the various features. The 3 o'clock position of the reference circle is the equinox (the point of intersection between the orbit of the sun — the ecliptica — and a plane through the equator of Earth). Thus, when the sun passes this point (21 March), the northern hemisphere enters the summer season, which will last until the sun passes the 9 o'clock position. The sun and moon both move counter-clockwise, the moon at about 13 degrees/day and the sun at about 1 degree/day. The cross you find between 12 and 1 o'clock is the perigee of the moon, which is the point closest to Earth in the moon's orbit. The perigee moves in the same direction as the sun and moon, but more slowly.

The shapes you see opposite each other near 11 and 5 o'clock are the nodes; i.e., the points of intersection between the orbit of the moon and the ecliptica. The ascending node is marked with a half cross that lacks the lower

bar, while the descending node is marked with a cross that lacks the upper bar. The nodes move in opposite directions from the sun and moon at very slow speeds.

Now continue the program by pressing SPACE. When you reach 08-01 1982 and the drawing of the (full) moon is finished, the program stops, sounds the bell twice, and in flashing letters informs you of a lunar eclipse!

While a program that simulates the movements of the planets around the sun by using Kepler's equation might be quite accurate, this is not the case when you simulate the moon orbiting Earth. The reason is that the actual deviations from the Keplerian method are not always negligible and might vary a few degrees. The user should be aware of this inherent inaccuracy that has an impact on the prediction of eclipses. Thus, when an eclipse warning (like the one you have just seen) is given, the actual eclipse might, in rare cases, take place the day prior to or the day after the date foreseen by the program.

I am aware that you could include the official predictions of eclipses, say for the past and next ten years, as a look-up table in the program. However, I have found it more interesting to relate the warnings to the locations of the sun, moon, and the nodes, as calculated and drawn by the program.

Eclipses can occur only when the sun and moon overlap [conjunction] as seen from Earth, or when they are exactly opposite from each other [opposition] as seen from Earth. Therefore, a prerequisite for the occurrence of a solar eclipse is that the longitude of the moon is equal to the longitude of the sun. A prerequisite for the occurrence of a lunar eclipse is that the difference between the solar and the lunar longitudes equals 180 degrees. In other

words, the moon is overtaking the sun (or its opposition) on the day of an eclipse. This condition is investigated in line 2010 by looking at the sign of the sinus of the said difference. A sign change is required.

The said condition, however, is not sufficient for an eclipse to occur. (If it were we would have an eclipse every fortnight!) In the case of a lunar eclipse, the moon must pass through the shadow of Earth (not above or below it). Earth and moon must thus be in line, within certain limits. This happens only when the sun (and thus also the moon) are sufficiently close to one

of the nodes. Therefore, conditions of eclipses are studied by investigating whether or not the sun is sufficiently close to one of the nodes at the moment when the sun and moon are in conjunction or opposition.

The location of the perigee is of interest when judging the extent of central solar eclipses. (Will they be total or annular?) Remember that the perigee is the point in the orbit of the moon closest to Earth. When the moon is close to the perigee its apparent size, as seen from Earth, is bigger than that of the sun, a prerequisite for a total lunar eclipse.

The date change takes place at midnight Greenwich mean time. To use local time, the following simple program change is required: if your time is behind Greenwich mean time (which is the case in the U.S.A.) by six hours, convert the hour difference to a decimal day difference ( $6/24 = 0.25$  in this case) and add the figure to the constant 715953.5 in line 6930; i.e., change 715953.5 to 715953.75.

You may contact Mr. Ostrup at Lindevangsvej 12, DK 3460 Birkerød, Denmark.

### Sun and Moon Listing

```

10 REM * SUN & MOON *
20 REM * BY SVEND ØSTRUP *
30 REM * LINDEVANGSVEJ 12 *
40 REM * 3460 BIRKERØD *
50 REM * DENMARK *
100 REM SET LOMEM AND/OR HIMEM IF NEEDED
105 REM Arrays X,Y and A contain plotting coordinates
110 DIM X(4,2): DIM Y(4,2): DIM A(4,2): DIM S(12)
120 GOTO 6000
199 REM Calculate angle VV from coordinates XX,YY by ATN
200 IF XX = 0 AND YY > 0 THEN VV = PI : RETURN
210 IF XX = 0 AND YY < 0 THEN VV = 3 * PI / 2 : RETURN
220 VV = ATN (YY / XX)
230 IF XX < 0 THEN VV = VV + PI
240 RETURN
290 REM Calculate Coordinates and Angle
300 V = V + Z * N: O = O + Z * H
310 MA = V - O: E1 = MA
320 EA = MA + E * SIN (E1)
330 IF ABS (E1 - EA) > .0005 THEN E1 = EA: GOTO 320
340 YY = SQR (1 - E * E) * SIN (EA)
350 XX = COS (EA) - E 360 RA = SQR (XX * XX + YY * YY) 370 GOSUB 200
380 A = VV + O
390 X = HU + K * RA * COS (A)
400 Y = ET - K * RA * SIN (A)
410 RETURN
499 REM Calculate plotting coordinates and longitude
500 O = O + Z * H
510 X0 = K * COS (O): Y0 = K * SIN (O)
520 RETURN
598 REM Calculates and prints elongation, and draws
599 REM picture of moon, showing phase at current date
600 DA = A(1,1) - A(0,1)
605 IF DA > 2 * PI THEN DA = DA - 2 * PI: GOTO 605
610 IF DA < 0 THEN DA = DA + 2 * PI: GOTO 610
615 EL = DA
620 IF DA > PI THEN DA = DA - PI: W = 1: GOTO 640
630 W = 0
640 VTAB 24: HTAB 29: PRINT " ELONG.:"
650 SV$ = RIGHT$ ( STR$ ( INT ( EL * F + .5) + 1000), 3)
660 HTAB 36: PRINT SV$: HTAB 1
670 FOR I = S1 TO -S1 STEP -1
680 RR = SQR (S2 - I * I)
690 IF W = 0 THEN HCOLOR = 3: GOTO 710
700 HCOLOR = 0
710 HPLLOT TF + RR * COS (DA), ET - I TO TF + RR, ET - I
720 IF W = 0 THEN HCOLOR = 0: GOTO 740
730 HCOLOR = 3
740 HPLLOT TF - RR, ET - I TO TF + RR * COS (DA), ET - I
750 NEXT
760 RETURN
950 HTAB 20 - LEN (Q$) / 2: PRINT Q$: PRINT : RETURN
999 REM Increment day number
1000 Z = Z + 1
1200 REM Calculate longitude and plotting coordinates
1201 REM for sun and moon, using subroutine 300
1202 REM SUN
1210 V = VS: N = NS: E = ES: K = KS: O = OS: H = HS
1220 GOSUB 300
1230 X(0,2) = X: Y(0,2) = Y: A(0,2) = A
1300 REM MOON
1310 V = VM: N = NM: E = EM: K = KM: O = OM: H = HM
1320 GOSUB 300

```

### Sun and Moon Listing (continued)

```

1330 X(1,2) = X: Y(1,2) = Y: A(1,2) = A
1398 REM Calculate longitude and plotting coordinates
1399 REM for nodes and perigee using subroutine 300
1400 REM NODES
1410 O = VN: H = NM: K = KN
1420 GOSUB 500
1430 X(2,2) = HU + X0: Y(2,2) = ET - Y0: A(2,2) = O
1440 X(3,2) = HU - X0: Y(3,2) = ET + Y0: A(3,2) = O + PI
1500 REM PERIHELION
1510 O = OM: H = HM: K = KP
1520 GOSUB 500
1530 X(4,2) = HU + X0: Y(4,2) = ET - Y0: A(4,2) = O
1599 REM Extinguish previous day's Sun, Moon, Nodes and Perigee
1600 XDRAW 1 AT X(0,0), Y(0,0)
1610 XDRAW 2 AT X(1,0), Y(1,0)
1620 XDRAW 3 AT X(2,0), Y(2,0)
1630 XDRAW 4 AT X(3,0), Y(3,0)
1640 XDRAW 5 AT X(4,0), Y(4,0)
1698 REM Print current date, taking change of month, years
1699 REM and leap years into account
1700 IF INT (D) > S(M) THEN D = D - S(M): M = M + 1
1710 IF M > 12 THEN M = M - 12: AA = AA + 1: T = T + 1
1720 IF T = 4 THEN T = 0
1730 IF T = 0 THEN S(2) = 29: GOTO 1750
1740 S(2) = 28
1750 HOME : VTAB 22: HTAB 29
1760 PRINT RIGHT$ (( STR$ ( INT (D) + 100), 2), " - "
1765 RIGHT$ (( STR$ (M + 100), 2), " " AA
1799 REM Plot current day
1800 DRAW 1 AT X(0,1), Y(0,1)
1810 DRAW 2 AT X(1,1), Y(1,1)
1820 DRAW 3 AT X(2,1), Y(2,1)
1830 DRAW 4 AT X(3,1), Y(3,1)
1840 DRAW 5 AT X(4,1), Y(4,1)
1899 REM Draw current day's Moon
1900 GOSUB 600
1950 Q = FRE (0)
2000 D1 = A(0,1) - A(1,1): D2 = A(0,2) - A(1,2)
2010 IF SGN ( SIN (D1)) = SGN ( SIN (D2)) THEN 5000
2020 C = SIN (D1) / ( SIN (D1) - SIN (D2))
2030 SK = A(0,1) - A(2,1) + C * (A(0,2) - A(2,2) - A(0,1) + A(2,1))
2040 LI = ABS ( COS (SK))
2099 REM Check Eclipse
2100 IF COS (D1) > 0 AND LI > 0.96639 THEN Q$ =
" SOLAR ECLIPSE" : GOTO 2200
2110 IF COS (D1) > 0 AND LI > 0.94604 THEN Q$ =
" POSSIBLE SOLAR ECLIPSE" : GOTO 2200
2120 IF COS (D1) < 0 AND LI > 0.98723 THEN Q$ =
" LUNAR ECLIPSE" : GOTO 2200
2130 IF COS (D1) < 0 AND LI > 0.97698 THEN Q$ =
" POSSIBLE LUNAR ECLIPSE" : GOTO 2200
2140 GOTO 5100
2200 VTAB 22: HTAB 1: FLASH: PRINT Q$
2210 NORMAL: PRINT: CALL BE: CALL BE
2220 PRINT " RE-START: <SPACE > " : GET SV$
2230 GOTO 5200
5000 FOR I = 0 TO 800: NEXT
5100 PE = PEEK (49152)
5110 IF PE = 155 THEN SV = PEEK (49168): TEXT = HOME: END
5120 IF PE = 205 THEN SV = PEEK (49168): GOTO 6700
5130 IF PE = 211 THEN SV = PEEK (49168): GET SV$
5199 REM Change current to previous, next to current
5200 FOR I = 0 TO 4

```

Sun and Moon Listing (continued)

```

5210 X(I,0) = X(I,1):X(I,1) = X(I,2)
5220 Y(I,0) = Y(I,1):Y(I,1) = Y(I,2)
5230 A(I,0) = A(I,1):A(I,1) = A(I,2)
5240 NEXT
5250 D = D + 1
5260 HCOLOR= 3
5270 GOTO 1000
6000 TEXT : HOME : VTAB 6
6010 Q$ = " APPARENT MOVEMENTS" :GOSUB 950
6020 Q$ = " OF" :GOSUB 950
6030 Q$ = " SUN AND MOON" :GOSUB 950
6040 Q$ = " AROUND THE EARTH" :GOSUB 950
6050 Q$ = " BY" :GOSUB 950
6060 Q$ = " SVEND ØSTRUP" :GOSUB 950
6070 Q$ = " FEBRUARY 1982." :GOSUB 950
6100 PI = 3.14159265:HU = 100:ET = 80:F = 180 / PI
6110 S1 = 30:S2 = 900:TF = 240
6120 BE = 64477: REM BELL
6200 REM SUN
6210 VS = 4.88968:NS = .01720279:ES = .0167259:KS = 72
6220 OS = 4.92624:HS = .00000082
6300 REM MOON
6310 VM = 5.43083:NM = .2299715:EM = .0549005:KM = 72
6320 OM = 4.46361:HM = .001944368
6400 REM ASCENDING NODE
6420 VN = 3.1188827:NN = - 0.000924219:KN = 63
6500 REM PERIHELION OF MOON
6510 KP = 59
6599 REM Load shape table at $300
6600 RESTORE : FOR I = 0 TO 66
6610 READ Q: POKE 768 + I,Q: NEXT
6620 POKE 232,00:POKE 233,03
6650 S(1) = 31:S(2) = 28:S(3) = 31:S(4) = 30:S(5) = 31:S(6) = 30
6655 S(7) = 31:S(8) = 31:S(9) = 30:S(10) = 31:S(11) = 30:S(12) = 31
6700 TEXT : HOME : VTAB 6
6710 PRINT : PRINT " ONCE CELESTIAL BODIES MOVE YOU CAN:"
:PRINT
6720 PRINT " STOP MOVEMENTS PRESS <S> "
6730 PRINT " RE-START MOV. PRESS <SPACE> "
6740 PRINT " NEW START DATE PRESS <M> "
6750 PRINT " EXIT PROGRAM PRESS <ESC> "
6760 PRINT : PRINT : PRINT
6800 INPUT " STARTING DATE (DD,MM,YYYY) " D,M,AA
6810 IF M < 1 OR M > 12 THEN 6700
6820 IF M = 2 AND D < 30 THEN 6900
6830 IF D > S(M) THEN 6700
6899 REM Calculate day number Z,0 is 12:00M,1/1/60 GMT
6900 T = INT ((AA / 4 - INT (AA / 4)) * 4 + .05)
6910 IF M < 3 THEN A0 = AA - 1:M0 = M + 13: GOTO 6930
6920 A0 = AA:M0 = M + 1
6930 Z = INT (365.25 * A0) + INT (30.6001 * M0) +
D - 715953.5
6950 FOR I = 0 TO 4:X(I,0) = 0:Y(I,0) = 180:A(I,0) =
0 : NEXT
7200 REM CALCULATE START SUN
7210 V = VS:N = NS:E = ES:K = KS:O = OS:H = HS
7220 GOSUB 300
7230 X(0,1) = X:Y(0,1) = Y:A(0,1) = A
7300 REM CALCULATE MOON
7310 V = VM:N = NM:E = EM:K = KM:O = OM:H = HM
7320 GOSUB 300
7330 X(1,1) = X:Y(1,1) = Y:A(1,1) = A
7400 REM CALC. NODES
7410 O = VN:H = NN:K = KN
7420 GOSUB 500
7430 X(2,1) = HU + X0:Y(2,1) = ET - Y0:A(2,1) = 0
7440 X(3,1) = HU - X0:Y(3,1) = ET + Y0:A(3,1) = 0 + PI
7500 REM CALC. PERIHELION
7510 O = OM:H = HM:K = KP
7520 GOSUB 500
7530 X(4,1) = HU + X0:Y(4,1) = ET - Y0:A(4,1) = 0
8000 HGR : HCOLOR= 3: SCALE= 1: ROT= 0
8010 FOR I = 0 TO 2 * PI STEP PI / 18
8020 H$ = HU + ET * COS (I),ET - ET * SIN (I)
8030 NEXT
8040 H$ = HU,70 TO HU,90
8050 H$ = HU,90,ET TO 110,ET
8060 H$ = HU,16,ET TO 20,ET
8070 H$ = HU,180,ET TO 184,ET
8080 GOTO 1000
9000 DATA 5,0,12,0,41,0,54,0,58,0,62,0,37,63,54,45,37,
228,63,23,54
9010 DATA 14,45,213,19,246,24,24,192,24,40,5,64,72,32,76,137,146,18
9020 DATA 45,0,37,63,54,45,37,228,63,23,54,14,45,5,0,103,21,6
9025 DATA 0,245,7,32,0,172,30,7,32,0
9030 END

```

MICRO

# 6502 DEBUG! FAST 'n EASY The PTD Language Way

```

05 LOC1 = $7C00
10 PC = $3FC7
20 LABEL: STEP 100 NODISP
30 IF X<$3E OR @LOC1#17 THEN GOTO LABEL
40 PRINT "HERE IS THE CULPRIT"
50 SHOW 100

```

PTD-6502 is a high speed, compiled BASIC-like language, light years ahead of the Apple II Single Stepper and far more sophisticated than any other 6502 debugger available. It allows you to sit back effortlessly while your computer glides through your code at a thousand instructions per second looking for your bugs. Or you can select a slower speed with updated display of memory. A paddle-controlled single stepper mode is also available. At either of the slower speeds, the PTD-6502 monitors and saves the last 128 instructions executed for review at any time.

Virtually unlimited breakpoint complexity is permitted with the PTD-6502. IF statements with mixed AND's and OR's can be created to test conditions such as memory change, memory = value, instruction location, ... and many others. You can have as many named breakpoints as you wish in both ROM and RAM.

Some other features of the PTD-6502 include • Fast subroutine execution. • Hex calculator/converter. • Hex/ASCII memory dump. • Up to 16 machine language cycle timers. • Ability to monitor specific labeled areas in memory while stepping. • Effective address. • Accessible monitor commands. • A documented module for relocation of the PTD-6502 to virtually any location (source code supplied).

The debugging program shown on the monitor is a simple example; it could be far more complex. If you can think of it, you can probably scan for it at 1000 instructions per second. If you're a professional, the PTD-6205 can pay for itself in the first few hours of use. If you're a novice, you'll soon be debugging like a pro.

ORDER: PTD-6502 Debugger  
including DOS 3.3 Disk  
and instruction manual .....

**\$49.95**

(Note that disk is not copy protected. Order only one for each business or institution.) In California, add 6.5% sales tax.

PTD-6502 requires Autostart ROM for fast breakpoint.



**PTERODACTYL  
SOFTWARE™**

1452 Portland Ave. • Albany CA 94706 • (415) 525-1605

# Microcomputers in a College Teaching Laboratory, Part 3

by Thor Olsen, Howard Saltsburg, Richard H. Heist

**Process control is illustrated using two simple experiments — an air bath and a simulated chemical reaction in an industrial-type chemical reactor. Circuits presented include an LED training device, AC power controller, and PET parallel port multiplexer.**

Part I of this series (MICRO 53:53) provided an overview of the undergraduate Chemical Engineering laboratory program at the University of Rochester. Part II (MICRO 55:59) focused on the use of computers for data acquisition in a laboratory environment. This article emphasizes the output of signals from the computer that, together with data acquisition, enables you to "close the loop" so a process or an instrument can be controlled with a microcomputer.

## Closing the Loop: Process Control

During the sophomore laboratory course, students learn to generate and control digital output signals from the microcomputer. A light-emitting diode (LED) module that attaches to the parallel port of the PET computer and maps the data bus to eight LEDs is the primary tool. The module is battery operated and completely self-contained (see figures 1 and 2). Although the module is simple, its effectiveness in visualizing operator control of the output port is remarkable. With this device, it is easy to demonstrate that the computer can be used to control any external device that requires simple on/off operation.

The use of the LED mapping illustrates a primitive form of control in which the eye acts as a sensor, and the

operator can respond manually to an error by making a change to correct the situation. This is, in fact, a form of open loop control. For laboratory and engineering purposes, however, the implementation of automatic, so called closed loop, control is of more interest. In closed loop control the operator defines a quantity called the process variable, such as the temperature, and selects a desired value (the set point) at which this variable should be maintained. The difference between the process variable and the set point (i.e., the error) is used to determine how the device that influences the process variable should respond to correct the error.

The home thermostat is a simple form of control; it controls the room temperature (the process variable) simply by turning the heater or air conditioner on and off. As is commonly experienced with this type of control, the room temperature will vary automatically and continuously about the set point. Without intelligent devices, it is difficult (and expensive) to utilize more sophisticated control strategies, which would give less variation about the set point. The microcomputer, however, is an ideal device for such tasks as it can be used in complex decision-making modes. In contrast to conventional analog control devices where the control strategy often is implemented by mechanical means, the microcomputer allows strategy to be easily changed as needed. All that is required is modification of the software.

Since the students have had experience in reading temperature with the thermistor/555 timer circuit and have learned to send digital information to an external device, such as the LED module, it is a relatively simple matter to combine the two functions in a process control experiment. Although the theory of process control is not

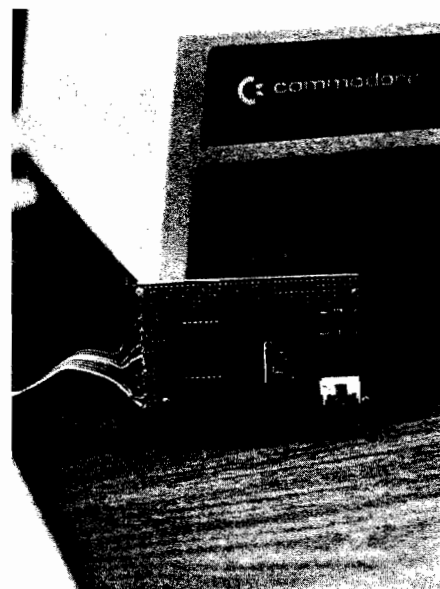

**Figure 1: Photograph of the battery-operated module used to map the PET data bus to eight LEDs.**

usually taught until the senior year, we have found that in the laboratory an introduction to the topic can be given to the sophomores.

A simple recirculating air heater, or air bath, provides a practical application of the theory. The students are required to write a program in Structured BASIC to effect the desired temperature control of the air bath with on/off and proportional control strategies. The success of a strategy is illustrated by running the program with the air bath interfaced to the microcomputer. Also, the air bath allows operator control of recirculated air *versus* intake of (cold) room air so that sudden changes can be made in the heat requirement of the system (load changes) to further test the control strategy. Because the air bath is simple and inexpensive, each computer can be equipped with its own system. Thus, each student has easy access to an experimental station where he can develop and test his program.



**The Air Bath**

The air bath consists of a box, 12 x 9 x 4 inches. The front cover is plexiglass; all other sides are made of wood, covered on the inside with aluminum foil. The box has a vertical partition, open at the top and bottom to allow circulation of air. Mounted inside the box is a light bulb, which is painted black (heater), and a fan to circulate the air. There are ventilation holes at the bottom on each side of the box and a sliding damper, which in one extreme position blocks the air exhaust vents, and in the other, the recirculation opening of the center partition. By moving the damper, the operator can impose a load change on the operating conditions of the box. A thermistor, located near the exhaust vents, is used with the 555 timer circuit to monitor the air temperature of the bath.

The AC power control circuit for the heater is shown in figure 3. The operation of the circuit can be described as follows: When the output line from the PET is high [logic 1], the 2N2222 transistor (Q1) is turned on, allowing current to flow through the LED of an optoisolator (IC1). When the LED is emitting, the photoconductor element of IC1, a TRIAC, will allow control current to flow to the power-controlling TRIAC (Q2), and the heater is turned on. This circuit permits only two operating states: power on and power off. Most control strategies, however, call for the use of fractions of full power. Fortunately, such fractional-power operation can be simulated by dividing the operating time into short "control intervals;" e.g., one second each, and turning the power on for that fraction of each control interval that corresponds to the fraction of full power called for by the control algorithm. Thus, a variety of more complex control strategies can be implemented, even with this simple type of hardware.

The air bath is also small enough so that the response time for a load change is only a minute or so, and the time required to reach a desired set point temperature of 50 degrees Celsius, starting from room temperature, is about five minutes. Although this response time is much shorter than that of most chemical process equipment, it is useful in the laboratory. The fast response provides a highly interactive situation, promotes independent efforts in development of the required control

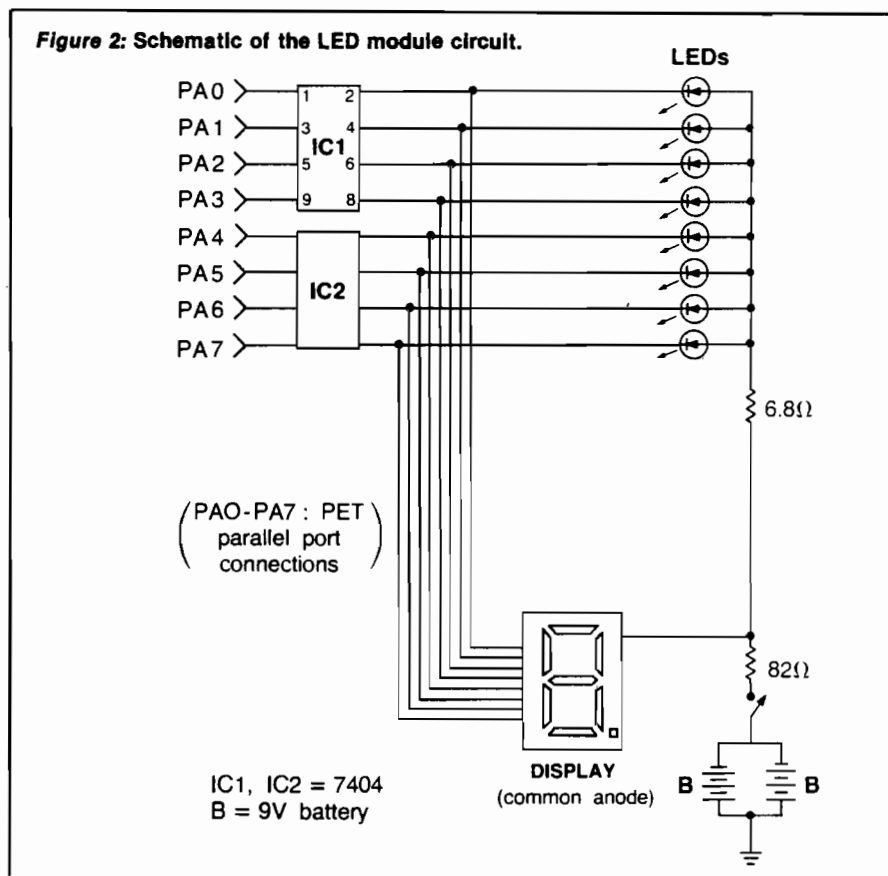

strategies, and permits exploration of alternative control modes.

With typical operating temperatures from 45 to 60 degrees Celsius, typical responses of the bath temperature to load changes are shown in figures 4 and 5. In figure 4 the PET is programmed to display data (including the measured air bath temperature) on the left side of the screen and plot the temperature on the right side. The set point temperature is represented by the

straight vertical line in the center of the plot. The time between successive screen display updates is about six seconds, although the temperature is measured and the heater power updated several times between consecutive screen updates. The peak in the temperature profile shown on the screen display reflects a momentary increase in temperature when the damper was closed. The control algorithm (power to heater proportional to the error —

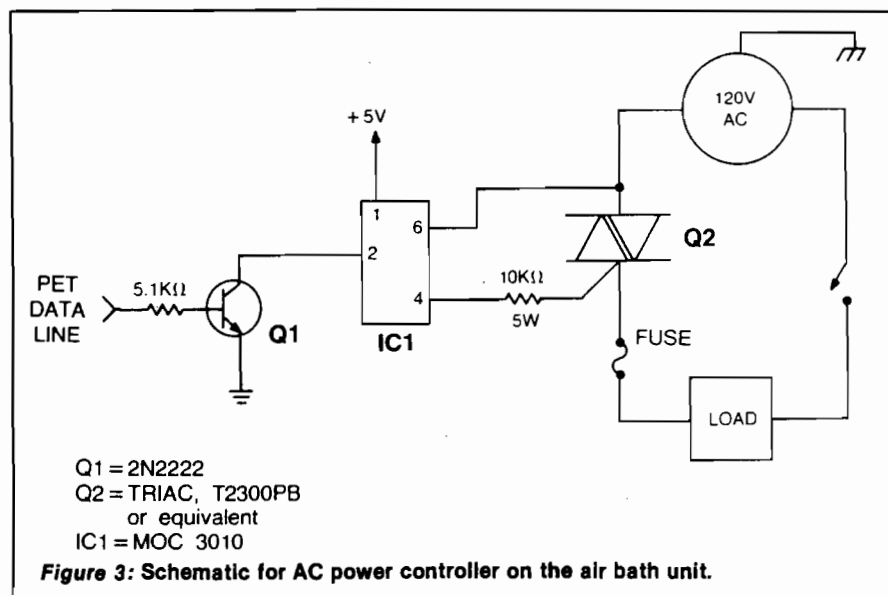

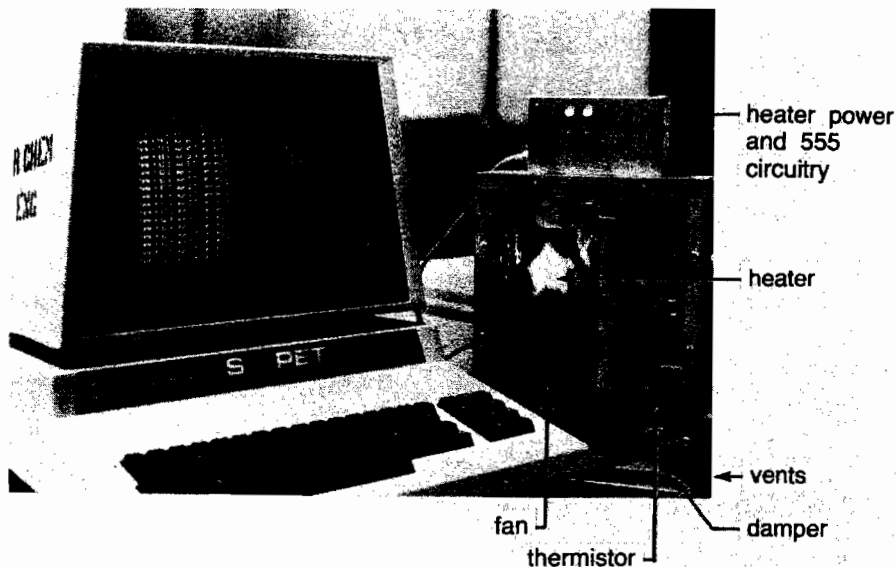
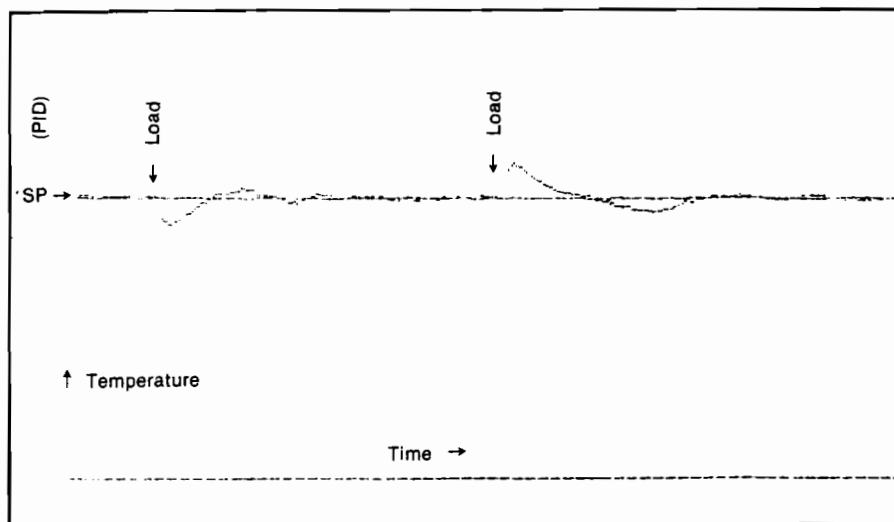

**Figure 4:** Photograph of the microcomputer/air bath combination used for process control experiments by our students. See text for description.

proportional control) gradually reduced the temperature toward the set point. A graph of the response of the bath temperature to a load change is shown in figure 5. Again, the center line indicates the set-point temperature. Note that the control algorithm used to generate the data in figure 5 involves corrections that are the sum of terms involving proportionality, time integral and time derivative of the error (PID), although the hardware is unchanged. The additional computations, relative

to proportional control, present no problem for the microcomputer, even when controlling a device with as short response times as the air bath.

The response to this project has been gratifying. The students apply the material they have learned during the semester and acquire confidence in the use of the computer in a laboratory environment. The concept of the computer being a tool is re-emphasized by its use in the solution of a realistic engineering problem.



**Figure 5:** High resolution, dot matrix printer output from an air bath experiment. The straight, center line represents the set point temperature, the trace is the actual temperature in the bath and the "load" markings indicate when the damper was opened and closed, respectively (see text). The time between the two load markings is approximately 12 minutes. The time for the bath to respond to a load change is typically around 5 - 10 seconds. The type of control procedure used in this experiment was PID (proportional-integral-derivative). See reference 3 for details concerning control strategies.

## The Continuous Stirred Tank Reactor

The air bath just described plays an important role in the students' laboratory experience. It is their first "real" chemical engineering experiment and clearly illustrates how the computer can be used to control a process device. The concepts used with the air bath are directly applicable to more realistic problems, but, unfortunately, the dynamic behavior of real process devices cannot be determined adequately from the study of such small-scale laboratory equipment. Therefore, it is important to deal with real industrial devices. Toward this end, a pilot-plant scale chemical reactor has been interfaced to a microcomputer. The reactor, shown in figure 6, is simply an oval tank surrounded by a water-cooled jacket and equipped with a stirrer.

The reactor is operated as a continuous stirred tank reactor (CSTR); i.e., reactants are continuously fed to the reactor, and a mixture of reactants and product is continuously withdrawn. Again, the problem is to control temperature, but the heat source is now, in principle, a chemical reaction. Rather than work with an actual chemical reaction, however, an exothermic [heat generating] reaction is simulated by feeding water to the CSTR (instead of reactants) and bleeding steam into the flow to heat the reactor contents. By controlling the rate of steam addition, the heat released by an actual chemical reaction can be simulated safely and inexpensively.

The process hardware allows three stream temperatures to be measured; the reactor output (product stream), and the cooling jacket input and output. Two variables can be controlled by the computer: 1. the flow rate of cooling water through the jacket (which controls the "reaction"); and, 2. the flow rate of steam into the reactor (which effects the simulation). The temperature measurements are made using thermistors and the 555 timer A/D<sup>2</sup>. The flow rates of cooling water and steam are regulated by two commercial flow controllers. An analog signal of 4 - 20 mA is required for each. The controller design further requires that once a current is set at a certain level, it must remain at that level until a change in controller setting is desired.

Since the design requires two output ports for the two flow controllers

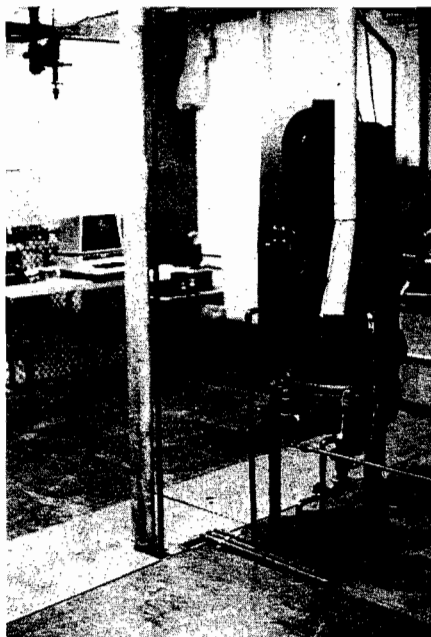

**Figure 6:** Photograph of the continuous, stirred tank reactor (CSTR). The actual reactor tank and cooling jacket comprise the oval portion of the device. (The bulky portion above the reactor contains the motor and variable-speed transmission for the stirrer.)

and one input port for the three thermistors, it was necessary to multiplex the PET parallel port. The circuit used is shown in figure 7; other versions have been described in the literature noted in reference 4. Details concerning the individual integrated circuits can be found elsewhere<sup>5</sup>, but a qualitative description of their circuit function may be useful. The 4066 integrated circuits are CMOS analog switches. Each chip contains four separate switches which, upon command from the computer, can be individually opened or closed. If a switch is closed, its internal resistance is only a few hundred ohms; if the switch is opened, its resistance increases by about ten orders of magnitude. The net effect of opening a switch is that a device connected to the data bus through this high resistance is effectively isolated from the bus. For instance, if the switches in the top 4066 chip in figure 7 are closed and all the switches in the remaining four 4066 chips are opened, the three 555 timers will be connected to the computer while the remaining elements will not affect the data bus. Thus, by selectively controlling the individual 4066 chips, the single parallel port can be multiplexed quite easily.

The selective control is provided by a 4556 CMOS binary to 1-of-4 decoder

integrated circuit (figure 7). By placing the binary representation of the numbers 0 to 3 on the input connections of the 4556 (labeled D101 and D102 in figure 7) any one of the four output connections can be activated (actually, deactivated since the selected output is brought to ground potential). Therefore, by using the computer to pass the numbers 0 to 3 to the 4556, any one of the three separate devices illustrated in figure 7 can be accessed. The fourth possibility is used to isolate all three devices from the data bus. Since the parallel port is in use, the 4556 decoder is connected to the IEEE-488 port, which is also available on the back of all PET computers. This port can be used as a data port in much the same manner as the parallel port<sup>6</sup>. The only

difficulty arises when the IEEE-488 port is to be used to communicate with another device, such as a printer or disk drive. Since the 4556 is also connected to the IEEE-488 bus, the different devices attached to the 4556 would be accessed whenever the state of the two data lines, D101 and D102, changed.

This problem is circumvented by using the enable command on the 4556 decoder. If the enable command is not activated the chip automatically ignores all input. Thus, irrespective of the contents of the IEEE-488 data bus, the devices multiplexed to the parallel port will not be disturbed if the enable command is not activated. The CB2 control line, available at the parallel port and accessible to the computer program, is used to control the 4556

**Figure 7:** Schematic of the PET parallel port multiplexing circuit described in the text.

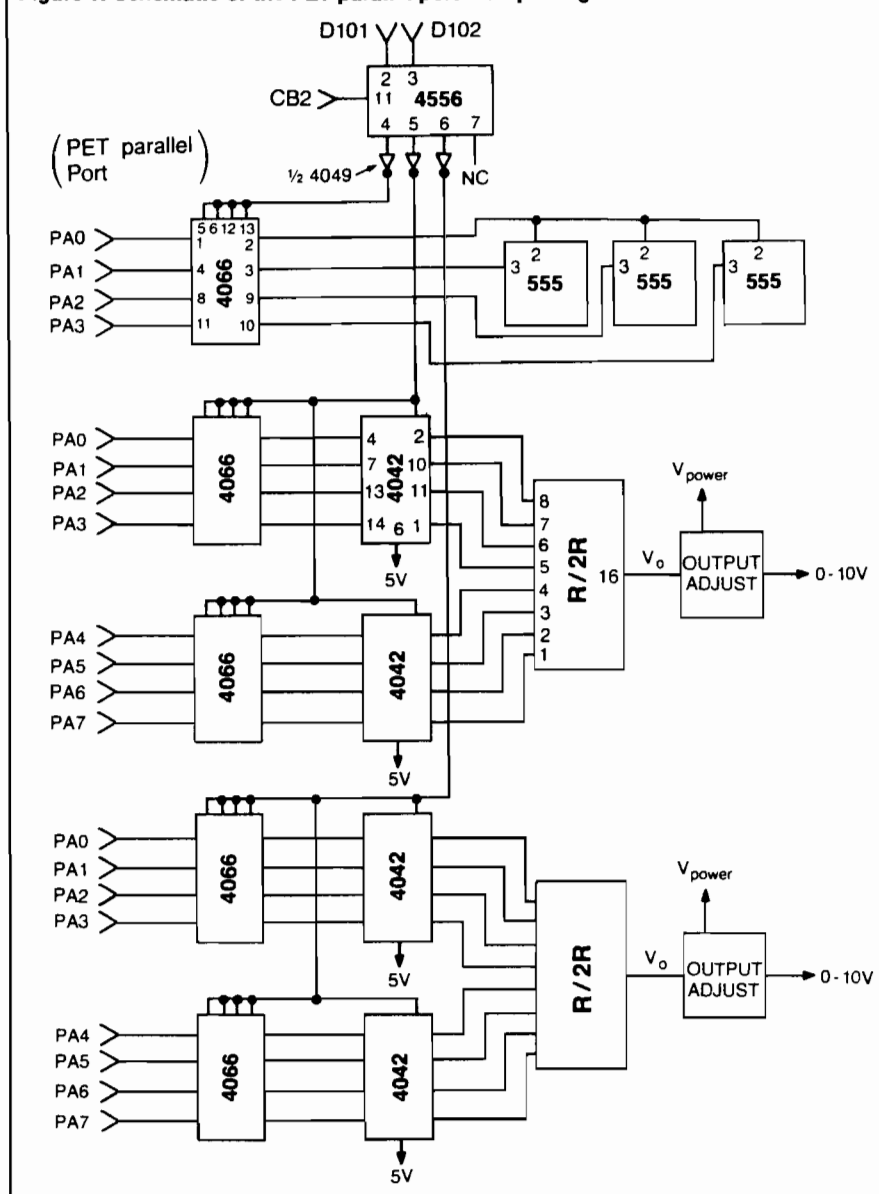

enable command. Details concerning the PET input/output ports are available from a variety of sources (references 4, 6-8) and will not be discussed here.

To carry out the control function, the microcomputer must generate an analog signal that must be passed to the flow controllers and maintained, even after the flow controller interface is removed from the data bus. The method employed for digital to analog (D/A) conversion utilizes an arrangement of precision resistors called an R/2R ladder network. Details of this method can be found in the literature in reference 9.

Essentially, the device produces a voltage output proportional to the value of the binary number applied to the network input. The output from the R/2R network should be buffered<sup>10</sup>. What is done with the output depends upon the specific application at hand. For example, if a range of voltage is required, the buffered output can be used with a Darlington network. If a current range is required, the buffered output is used to drive a current source. In this

particular example, the flow controllers for the cooling jacket and the steam line to the CSTR are current-to-pressure devices. This means that a range of input current (4 mA to 20 mA, in this case) is required to control the rate of fluid flow from no flow to full flow. The fraction of full flow is thus determined by the number (0 produces no flow, 255 produces full flow) placed on the PET parallel port by the computer program. The circuit currently in use with the CSTR that provides this range of current is shown in figure 8.

The binary number passed to the input of the R/2R network is maintained after the flow controller interface is isolated from the data bus by using CMOS 4042 latches (figure 7). The latch passes a binary number from the input to the output connections upon command, and then, on command, "latches" or holds that number on the output connections irrespective of what happens at the input. Thus, when one of the flow controller interfaces is selected, a number is placed on the I/O port reflecting a desired setting for the controller. This number is latched so

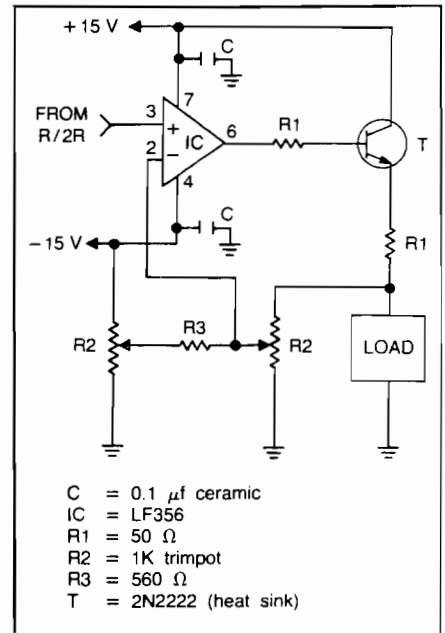

**Figure 8:** Schematic of the current source used to actuate the flow controllers described in the text. The LOAD indicated in the schematic represents the flow controller. The circuit is designed to produce a linear variation in output current from 4 mA at zero volts (0 binary) to 20 mA maximum (255 binary). See text for additional details.

<h2 style="display: inline; margin: 0 10px;">HARDWARE</h2>		<h2 style="display: inline; margin: 0 10px;">SOFTWARE</h2>	
<p><b>THE TACKLER™</b> — DUAL • MODE PARALLEL INTERFACE FOR THE APPLE® 2 BOARDS IN ONE FOR NO MORE COMPATIBILITY PROBLEMS!</p> <p>An intelligent board to provide easy control of your printer's full potential. Plus a standard parallel board at the flip of a switch — your assurance of compatibility with essentially all software for the APPLE®. Hires printing with simple keyboard commands that replace hard to use software routines. No disks to load. Special features include inverse, doubled, and rotated graphics and many text control features, available through easy keyboard or software commands. Uses industry standard graphics commands. This is the first truly universal intelligent parallel interface! Change printers — no need to buy another board. Just plug in one of our ROM'S and you're all set. ROM'S available for Epson, C. Itoh, NEC, and Okidata — others available soon. Specify printer when ordering. Call for Price.</p>		<p><b>Super Pix</b>                  Hires screendump software for the Epson, OKI, C. Itoh and Nec 8023. Use with Tymac PPC-100. Special <b>\$19.95</b> (Specify Printer)</p> <p><b>Mr. Lister — Customer Contact Profiler &amp; Mailer</b>                  A Super Mail List Plus more — up to 1000 Entries on single 3.3 Disk (only 1 Drive required) — 2 second access time to any name — full sort capabilities — Dual Index Modes — supports new 9 digit Zip. Easy to follow manual — Not Copy Protected — 4 user defined tables with 26 sort selections per table — Beta tested for 6 months — user defined label generation. Introductory Price <b>\$135.</b> <b>\$99.00</b> Dealer &amp; Dist. Inquiries Invited.</p>	
<p><b>THE UPGRADEABLE PPC-100 PARALLEL PRINTER CARD</b></p> <p>A Universal Centronics type parallel printer board complete with cable and connector. This unique board allows you to turn on and off the high bit so that you can access additional features in many printers. Easily upgradeable to a fully intelligent printer board with graphics and text dumps. Use with EPSON, C. ITOH, ANADEX, STAR-WRITER, NEC, OKI and others with standard Centronics configuration. <b>\$139.00</b></p>		<p><b>APPLE LINK</b>                  A communications system for the Apple® (Requires Hayes Micro Modem). Transmit and receive any type of file between APPLES®, Automatic multi-file transfer, real time clock indicating file transfer time. Complete error check. Plus conversation mode. Only one package needed for full transfers. Compatible with all DOS file types. (requires Hayes Micro Modem) <b>\$59.00</b></p>	
<p><b>IF YOU WANT GRAPHICS AND FORMATTING THEN CHOOSE THE PERFORMER</b></p> <p>for Epson, OKI, NEC 8023, C. ITOH 8510 provides resident HIRES screen dump and print formatting in firmware. Plugs into Apple slot and easy access to all printer fonts through menu with PR# command. Use with standard printer cards to add intelligence. <b>\$49.00</b> specify printer.</p>		<p><b>THE APPLE CARD/ATARI CARD</b>                  Two sided 100% plastic reference card Loaded with information of interest to all Apple and Atari owners. <b>\$3.98</b></p>	
<p><b>THE MIRROR FIRMWARE FOR NOVATION APPLE CAT II®</b></p> <p>The Data Communication Handler ROM Emulates syntax of an other popular Apple Modem product with improvements. Plugs directly on Apple CAT II Board. Supports Videx and Smarterm 80 column cards, touch tone and rotary dial, remote terminal, voice toggle, easy printer access and much more. List <b>\$39.00</b> Introductory Price <b>\$29.00</b></p>		<p><b>NIBBLES AWAY II</b>                  AGAIN! Ahead of all others.</p> <ul style="list-style-type: none"> <li>• <b>AUTO-LOAD PARAMETERS</b> . . . Free's the user from having to Manually Key in Param values used with the more popular software packages available for the Apple II.</li> <li>• <b>EXPANDED USER MANUAL</b> . . . incorporates new Tutorials for all levels of expertise: Beginners Flowchart for 'where do I begin' to 'Advanced Disk Analysis' is included.</li> <li>• <b>TRACK/SECTOR EDITOR</b> . . . An all new Track/Sector Editor, including the following features: Read, Write, Insert, Delete Search, and impressive Print capabilities!</li> <li>• <b>DISK DIAGNOSTICS</b> . . . Checks such things as: Drive Speed, Diskette Media Reliability, and Erasing Diskettes.</li> <li>• <b>HIGHEST RATED</b> . . . Best back up Program in Softalk Poll (Rated 8.25 out of 10).</li> <li>• <b>CONTINUAL UPDATES</b> . . . Available from Computer Applications and new listings on the source. <b>\$69.95</b></li> </ul>	
<p><b>MINI ROM BOARDS</b>                  Place your 2K program on our Mini Rom Board. Room for one 2716 EPROM. Use in any slot but zero. Only <b>\$34.95</b></p>		<p><b>DOUBLE DOS Plus</b>                  A piggy-back board that plugs into the disk-controller card so that you can switch select between DOS 3.2 and DOS 3.3 DOUBLE DOS Plus requires APPLE DOS ROMS. <b>\$39.00</b></p>	
		<p><b>Dealer and Distributor Inquiries Invited.</b></p> <p><b>MICRO-WARE DIST. INC.</b>                  P.O. BOX 113 POMPTON PLAINS, N.J. 07444  <b>201-838-9027</b></p>	

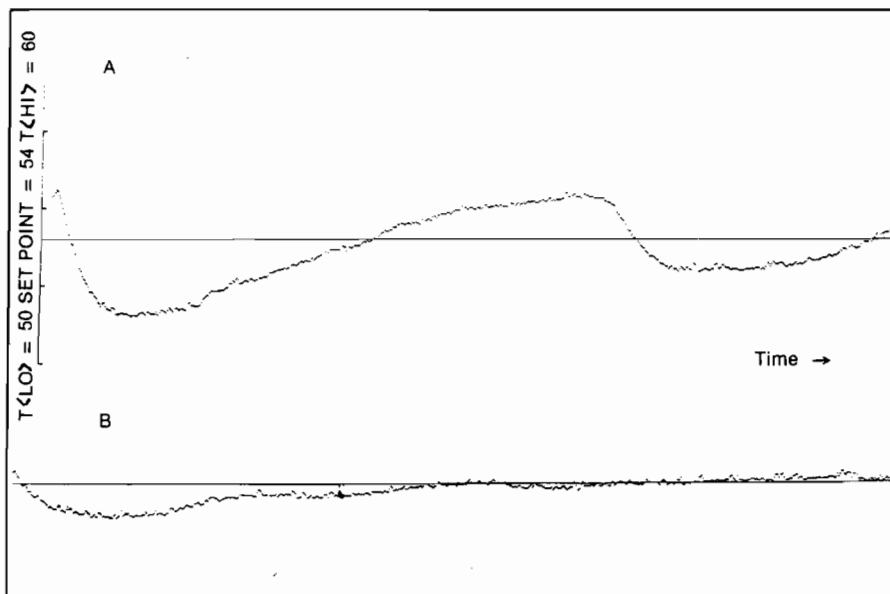

**Figure 9:** Typical high resolution, dot matrix printer output from a control experiment using the CSTR. The curve marked "B" is a continuation of curve "A". The center line in each trace indicates the set-point temperature, and the trace is the output-stream temperature of the CSTR. The response time to a load change for the CSTR is typically 4 - 5 minutes. The time between the first trough and the second peak on plot "A" is approximately 40 minutes. The control strategy used in this experiment is called proportional-integral (PI).

that it will remain as input to the R/2R network. The 4042 IC is then isolated from the I/O port, which becomes available for communication with another device.

The control of the multiplexed port, the temperature measurements, and the control of the flow controllers are accomplished entirely with software. A typical graph of the output temperature for the CSTR, as it responds to a load change, is shown in figure 9. Note in the figure caption the much longer time scales relative to the air bath experiment. With the CSTR the students receive first-hand experience with the problems associated with control of equipment — especially with the slow response time characteristic of many industrial devices.

Usually students don't become involved with the complicated CSTR until the senior laboratory course. The control experiments in the senior laboratory course primarily involve studies of the dynamic response of the CSTR to load changes when different control strategies (algorithms) are used.

In the final article of this series, we will discuss the interfacing of microcomputers to complex scientific instrumentation. Specific examples involving gas chromatography and converting a single beam spectrophotometer into an

effective dual beam instrument will be presented.

#### REFERENCES

1. H. Saltsburg, R. H. Heist, and T. Olsen, "Microcomputers in a College Teaching Laboratory, Part 1," *MICRO* 53:53, October, 1982.
2. R. H. Heist, T. Olsen, and H. Saltsburg, "Microcomputers in a College Teaching Laboratory, Part 2," *MICRO* 55:59, December, 1982.
3. R. J. Bibbero, "Microprocessors in Instruments and Control," (John Wiley and Sons, New York, 1977), Chapter 2.
4. J. M. Downey and S. M. Rogers, "PET Interfacing," (Howard W. Sams & Co., Inc., Indianapolis, 1981).
5. See, for example, "Motorola CMOS Integrated Circuits," (Motorola Inc., 1978), 2nd ed.; D. Lancaster, "CMOS Cookbook," (Howard W. Sams and Co., Inc., Indianapolis, 1979).
6. E. Fisher and C. W. Jensen, "PET and the IEEE-488 Bus (GPIB)," (Osborne/McGraw-Hill, Berkeley, 1980).
7. See, for example, N. Hampshire, "The PET Revealed," (Computabits Ltd., Somerset, England,

- 1980); R. C. West, "Programming the PET/CBM, The Reference Encyclopedia for Commodore PET/CBM Users," (COMPUTE! Books, Greensboro, 1982).
8. See, for example, R. Zaks, "6502 Applications Book," (SYBEX Inc., 1979); M. L. DeJong, "Programming and Interfacing the 6502, with Experiments," (Howard W. Sams and Co. Inc., Indianapolis, 1980).
9. Z. H. Meiksin and P. C. Thackray, "Electronic Design with Off-The-Shelf Integrated Circuits," (Parker Publishing Co., Inc., West Nyack, NY, 1980), pgs. 307-310.
10. W. Jung, "IC op-amp Cookbook," (Howard W. Sams and Co., Inc., Indianapolis, 1979).

You may contact the authors at the Department of Chemical Engineering, University of Rochester, Rochester, NY 14627.

**MICRO**

# Looking

for a Good Buy?

Have you read our

## MICRObits?

You'll find deals on Software, Hardware, User Groups, Accessories, Games, Joysticks, Books, Newsletters, and much more!

See our classifieds this month, on page 77.



# ROCKWELL Microcomputers from Excert, Inc.

## THE AIM 65/40 Single Board or Smorgasbord



- A full size terminal style keyboard w/8 special function keys
- A smart, 40 character display with its own microprocessor
- A 40 column printer w/text and graphic output
- Up to 64K of on-board RAM and ROM
- On-board interfaces include RS232, dual audio cassette and 2 user I/O R6522 devices
- Firmware includes interactive monitor and text editor w/options of Assembler, BASIC, FORTH and PL/65

## THE AIM 65 Take-Out Order



- A full size terminal style keyboard w/3 special function keys
- A 20 character display
- A 20 column printer w/text and graphic output capability
- Up to 4K RAM and 20K ROM on-board
- On-board interfaces include 20MA TTY, dual audio cassette and 1 user I/O R6522 device
- Firmware includes interactive monitor and text editor w/options of Assembler, BASIC, FORTH, PASCAL, & PL/65

And if the above isn't enough,  
Try the RM65 — a product line filled with embellishments including:

32K DRAM Board  
CRT Controller  
Floppy Disk Controller  
PROM Programmer

ACIA Board  
IEEE-488Board  
CPU/SBC Board  
4-16 Slot Card Cages

Prototype cards  
Adaptor Buffer Modules  
General Purpose I/O Board  
PROM/ROM Board

### NEW LOWER PRICES AND A CASH DISCOUNT\* TO BOOT!

A65/40-16 (16K RAM)	\$1225
A65/40-32 (32K RAM)	\$1295
A65/40-A (Assembler)	\$ 85
A65/40-B (BASIC)	\$ 65

A65-1 (1K RAM)	\$420
A65-4 (4K RAM)	\$445
A65-4B (4K RAM w/BASIC)	\$495
A65-PS (PASCAL)	\$100
A65-F (FORTH)	\$ 65
A65-A (Assembler)	\$ 35

Mail Order to:

### Educational Computer Division EXCERT INCORPORATED

- SALES
- SERVICE
- INSTALLATION
- CONSULTING

P.O. Box 8600  
White Bear Lake, MN 55110  
(612) 426-4114

Higher quantities quoted upon request, COD's accepted, shipping will be added. \*Deduct 5% cash discount on prepaid orders. Minnesota residents add 5% sales tax. Prices subject to change without notice.

# Measurement of a 35mm Focal Plane Shutter

by Mike Dougherty

**The program SHUTTER uses inexpensive hardware to measure the accuracy and repeatability of the focal plane shutter found in most single-lens reflex cameras.**

## SHUTTER

requires:

Atari 800 (may be modified for others) and a few electronic components

Acting as the logic controller for hardware sensors, a computer can be used to measure events beyond human capabilities. One such event is the movement of a camera's focal plane shutter. A typical focal plane shutter is capable of exposing film from 1/1000th of a second to a full second. However, it is difficult to determine the shutter's accuracy. The following program, accompanied by simple hardware, gives the computer/photographer hobbyist a means to measure the accuracy and reliability of a focal plane shutter. Although SHUTTER was written for an Atari 800 personal computer, the basic concepts are transportable to other systems and the program can be converted.

## Definitions

A focal plane shutter consists of two opaque curtains that move in front of the photographic film. Light comes through these curtains, which form a window or opening, and strikes the film. The amount of exposure is determined by the distance between the two curtains and the speed that the curtains move across the film. Looking from the back of my camera, the curtains move from right to left, exposing a vertical slice of film. This particular camera maintains a constant curtain speed while changing the distance between

the curtains for different exposures. It is called a focal plane shutter because, for the best performance, the shutter must be placed as close to the plane of focus as possible.

The photographer is concerned with two inaccuracies in this type of shutter — actual exposure and exposure consistency. Obviously, for good photographic results, the shutter should produce the desired exposure. However, any inaccuracy in the shutter may be corrected by changing the lens opening — as long as the shutter is consistent. Thus, in practice, consistency is usually more important than absolute accuracy.

Note that there is much practical latitude in the photographic process. Exposure errors as large as 33% ( $\frac{1}{3}$  of an f/stop) may be unnoticed by some. Further, errors in exposure can often be corrected. However, each compensation or correction also compromises the final photographic result. To achieve the maximum photographic quality possible, every phase of the photographic process must be understood and utilized to its fullest degree.

The first step, exposure of the film, is no exception.

## Hardware

The light sensor used by SHUTTER consists of two elements: a phototransistor and a 10K resistor. The phototransistor (Radio Shack #276-130) does the actual work of detecting the light, while the resistor limits the current flow into the computer. The typical circuit for one light sensor is shown in figure 1.

Figure 1: Phototransistor Light Sensor

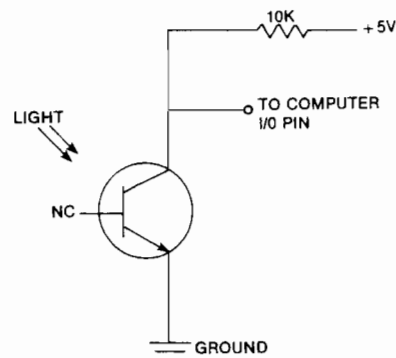

## Listing 1

```

100 REM ..... SHUTTER .....
105 REM
110 REM ... by Mike Dougherty
115 REM
120 REM A program to measure the shutter
125 REM speed of a focal plane shutter
130 REM using phototransistors.
135 REM
140 REM
145 REM .....
150 REM
155 REM
1010 DIM SAMPLE(9),KEY*(1)
1020 GRAPHICS 0:POKE 752,1
1030 PRINT "Initializing USR functions"
1110 GOSUB 10000:REM INIT USR FUNCTIONS
1210 F=1.79*1000000:REM ATARI CLOCK IS 1.79 MHZ
1220 PORT=54017:REM JOYSTICK I/O PORT
1230 DELAY=0:REM USR DELAY CONSTANT
1240 ERROR=0:REM DETECTOR ERROR
1250 CDIST=24.64:REM DISTANCE BETWEEN VELOCITY SENSORS
1300 REM
1301 REM ... Main Program
1302 REM
1303 REM POLL USER FOR WHICH OF THE
1304 REM THREE FUNCTIONS TO EXECUTE.

```

While in the dark, the phototransistor is turned off and the current flows into an I/O pin of the computer with a voltage of +5V. When the light exceeds a specific threshold level, the phototransistor turns on and current flows to ground giving a zero voltage at the I/O pin. Thus, a computer I/O pin will be a logic 1 (+5V) in the dark and a logic 0 (ground) in sufficient light. For the Radio Shack phototransistor, sufficient light consists of a 50-watt reflector bulb (available from Sears) at a distance of 50 cm from the phototransistor. To measure the focal plane shutter exposure, the program simply measures the time that the I/O pin connected to the phototransistor remains low.

Unfortunately, there is a major source of error when measuring the highest shutter speeds. This error originates from the finite size of the light sensitive silicon in the phototransistor — 0.5 millimeters (mm) in my case. Since this is not infinitely small (or small enough to ignore), the shutter time measured will be longer than it should be. As the two curtains in my camera move toward the left, the I/O pin goes to zero when the left curtain uncovers the right edge of the light-sensitive silicon. (The response is virtually immediate since the source light is bright enough to drive the phototransistor into saturation with only a fraction of the silicon exposed to light.) The I/O pin will remain zero until the right curtain covers the left edge of the light-sensitive silicon. Instead of measuring the exposure time for an infinitely thin slice of film, a slice of 0.5 mm in width is measured. For my camera at 1/1000th of a second, this error becomes significant.

To eliminate the finite detector size error, the time required to cross the light sensitive silicon was determined and subtracted from the measured shutter time. To measure this time error, the velocity of the shutter curtains and the size of the light-sensitive area were measured. The light detector width, WIDTH, was measured by an accurate drafting scale and found to be 0.5 mm. (For the purposes of this article, I shall assume that this measurement contains no error!)

To measure the shutter velocity, only the velocity of the left curtain had to be measured. The right curtain must move at the same speed or one side of the film would receive more exposure

## Listing 1 (Continued)

```

1305 REM
1310 GRAPHICS 0
1315 POSITION 5,5:PRINT "Select function"
1320 POSITION 7,7:PRINT " M - Monitor"
1322 POSITION 7,8:PRINT " V - Velocity"
1324 POSITION 7,9:PRINT " S - Shutter"
1330 POSITION 22,5:INPUT KEY$:REM INPUT USER CHOICE
1410 IF KEY$="S" THEN GOSUB 2000:GOTO 1310
1420 IF KEY$="V" THEN GOSUB 3000:GOTO 1310
1430 IF KEY$="M" THEN GOSUB 4000:GOTO 1310
1435 REM
1436 REM ... SOUND ERROR INPUT
1437 REM
1440 SOUND 0,150,10,8
1450 FOR WAIT=0 TO 50:NEXT WAIT
1460 SOUND 0,0,0,0
1470 GOTO 1320
2000 REM
2001 REM ... Shutter Function
2002 REM
2003 REM This function measures the
2004 REM actual exposure time of the
2005 REM shutter and computes the
2006 REM relative error. The variable
2007 REM ERROR should be set via the
2008 REM Velocity function prior to
2009 REM running this function.
2010 REM
2110 GRAPHICS 0
2120 PRINT "Expected time in ms ";
2130 INPUT EXPECT
2140 ROUTINE=1536:REM 1ST USR FUNCTION
2150 MASK1=2:REM BIT #1 PHOTOTRANSISTOR
2160 MASK2=0:REM NOT USED
2170 GOSUB 9000
2180 PRINT "Shutter error:      ";(EXPECT-AVE)/EXPECT*100;"%"
2190 GOSUB 8000
2200 RETURN
3000 REM
3001 REM ... Velocity Function
3002 REM
3003 REM This function measures the
3004 REM leftward velocity of the
3005 REM shutter curtains. This
3006 REM speed is used to compute the
3007 REM error due to a finite sensor
3008 REM size. The variable CDIST,
3009 REM measured with the aid of the
3010 REM Monitor function, is combined
3011 REM with the detector width to
3012 REM compute ERROR. This function
3013 REM should be run prior to the
3014 REM Shutter function for every
3015 REM shutter speed with a different
3016 REM shutter curtain velocity.
3017 REM
3110 GRAPHICS 0
3120 PRINT "Detector width in mm ";
3130 INPUT WIDTH
3140 ROUTINE=1664:REM 2ND USR FUNCTION
3150 MASK1=1:REM BIT #0 PHOTOTRANSISTOR
3160 MASK2=4:REM BIT #2 PHOTOTRANSISTOR
3170 ERROR=0:REM COMPUTING NEW ERROR
3180 GOSUB 9000
3190 ERROR=(WIDTH*AVE)/CDIST
3195 ERROR=INT(ERROR*100+0.5)/100
3200 PRINT "Detector error:      ";ERROR;" ms"
3210 GOSUB 8000
3220 RETURN
4000 REM
4001 REM ... Monitor Function
4002 REM
4003 REM This function is used to
4004 REM assist measuring the distance
4005 REM between the velocity sensors.
4006 REM This sensor distance, CDIST,
4007 REM should be edited into line
4008 REM 1250 of SHUTTER. The Monitor
4009 REM function monitors all three
4010 REM phototransistor inputs. Press
4011 REM any key to exit.
4012 REM
4110 GRAPHICS 0
4120 CHANNELS=PEEK(PORT):REM SAMPLE JOYSTICK #3 & #4
4130 FOR I=0 TO 2:REM ONLY FIRST 3 BITS
4140 CHAN=CHANNELS-INT(CHANNELS/2)*2:REM ISOLATE BIT

```

## Listing 1 (Continued)

```

4150 PRINT "Bit #";I;" ";CHAN;" ";
4160 CHANNELS=INT(CHANNELS/2)
4170 NEXT I
4175 PRINT
4180 IF PEEK(764)=255 THEN 4120
4190 POKE 764,255
4200 RETURN
8000 REM
8001 REM ... Pause subroutine
8002 REM
8003 REM Wait until a key is pressed
8004 REM with a flashing prompt.
8005 REM
8110 POKE 752,1
8120 POSITION 7,22:PRINT "Hit any KEY to continue";
8140 POSITION 7,22:PRINT " ";
8160 IF PEEK(764)=255 THEN 8120
8170 POKE 764,255
8180 RETURN
9000 REM
9001 REM ... Sample Phototransistors
9002 REM
9003 REM This subroutine samples ten
9004 REM shutter releases and computes
9005 REM the simple statistics of
9006 REM average, AVE, standard deviation,
9007 REM SD, and the normalized standard
9008 REM deviation (NSD). This subroutine
9009 REM calls the USR function starting
9010 REM at the memory location ROUTINE.
9011 REM The bit masks, etc., are
9012 REM parameterized to allow this
9013 REM subroutine to be used by both
9014 REM the Velocity function and the
9015 REM Shutter function.
9016 REM
9100 PRINT
9110 FOR LOOP=0 TO 9 STEP 1
9120 IF PEEK(PORT)<>255 THEN 9120:REM WAIT UNTIL SHUTTER CLOSED
9130 CYCLES=USR(ROUTINE,PORT,MASK1,MASK2,DELAY)
9135 REM CONVERT MACHINE CYCLES TO MICROSECONDS, THEN MILLISECDS
9140 TIME=((37+5*DELAY)*CYCLES)/F
9150 SAMPLE(LOOP)=INT(TIME*100000+0.5)/100-ERROR
9160 PRINT " TIME #";LOOP;" IN 1/1000 SEC: ";SAMPLE(LOOP)
9170 NEXT LOOP
9180 SOUND 0,100,10.15:FOR WAIT=0 TO 2:NEXT WAIT:SOUND 0,0,0,0
9185 REM COMPUTE THE STATISTICS
9190 AVE=0
9200 FOR LOOP=0 TO 9
9210 AVE=AVE+SAMPLE(LOOP)
9220 NEXT LOOP
9230 AVE=AVE/10
9240 VAR=0
9250 FOR LOOP=0 TO 9
9260 VAR=VAR+(SAMPLE(LOOP)-AVE)^2
9270 NEXT LOOP
9280 SD=SQR(VAR/9)
9290 PRINT :PRINT "AVERAGE TIME: ";AVE
9300 PRINT "STANDARD DEVIATION: ";SD
9310 PRINT "NORMALIZED SD (NSD): ";SD/AVE*100
9320 RETURN
10000 REM
10001 REM ... U S R   P O K E
10002 REM
10003 REM Poke the USR functions into
10004 REM reserved page 6 memory:
10005 REM $0600 - $06FF.
10006 REM
10010 DIM BYTE$(2)
10020 TRAP 10200:REM EXIT WHEN NO MORE DATA
10030 READ ADDRESS:REM USR STARTING ADDRESS
10100 READ BYTE$:REM READ MACHINE CODE BYTE
10110 IF BYTE$="**" THEN SOUND 0,0,0,0:GOTO 10030:REM
                                                    END OF THIS USR FUNCTION
10120 GOSUB 10500:REM COMPUTE BYTE
10130 POKE ADDRESS,BYTE:REM PUT IN MEMORY
10140 ADDRESS=ADDRESS+1:REM NEXT MEMORY ADDRESS
10150 GOTO 10100
10200 RETURN
10500 REM
10501 REM ... BYTE$ --> BYTE
10502 REM
10510 BYTE=0
10520 V=ASC(BYTE$(1)):GOSUB 10600
10530 V=ASC(BYTE$(2)):GOSUB 10600
10540 RETURN
10600 REM

```

(continued)

than the other side. Two additional phototransistors were added to the sensor, one at each edge of the film opening. These phototransistors were used to measure the time from when the left curtain passed the right edge of the first sensor until the left curtain passed the right edge of the second sensor. The distance between the two phototransistors was determined by monitoring the two light sensor I/O pins via the SHUTTER Monitor function. On my hardware sensor, the distance measured was 24.64 mm. (Again, for this article, I will assume that this measurement contains no error.)

Once the focal plane curtain velocity,  $V$ , is known, the time error may be computed:

$$\text{ERROR} = \text{WIDTH}/V$$

My focal plane shutter curtain traveled the 24.64 mm of CDIST in 9.24 milliseconds [ms]. This yields a velocity of

$$V = 24.64\text{mm}/9.24 \text{ ms} = 2.67 \text{ mm/ms} = 5.97 \text{ mph}$$

For the 0.5 mm detector:

$$\text{ERROR} = 0.5 \text{ mm}/2.67 \text{ mm/ms} = 0.19 \text{ ms}$$

With a 1/1000th of a second (1 ms) shutter speed, ERROR represents a 19% relative error.

The final hardware sensor consisted of three phototransistors mounted horizontally in a cardboard case — inexpensive but effective! This case was attached to the back of the camera (behind the focal plane shutter) with the phototransistors positioned in the film plane. A 50-watt reflector lamp was positioned 50 cm from the front of the camera directing light toward the phototransistors mounted on the other side of the shutter. The shutter measurement was performed without a lens mounted on the camera. The three sensor outputs were connected from right to left (looking from the back) to the least significant bits (bit #0, bit #1, and bit #2) of the Atari joystick #3 (STICK(2)) input port. This joystick is located at the hardware register address 54017, PORTB. All joystick ports are configured as input ports by the Atari operating system upon power up. Both the +5V and ground are obtained from the 9-pin joystick port. Here are the joystick pinouts:

Pin #1 Right velocity phototransistor (Bit #0)  
 Pin #2 Shutter phototransistor (Bit #1)  
 Pin #3 Left velocity phototransistor (Bit #2)  
 Pin #7 +5V power  
 Pin #8 Ground

Be sure to read the *Atari Hardware Manual* (available from Atari) before blindly wiring to the joystick connectors. Damage to the Atari may result from improper use. Therefore, most of my hardware projects use PORTB; in case of a faulty design, PORTA (joysticks #1 and #2) is still available for Star Raiders!

### Software

SHUTTER is divided into three functions that allow the calibration of the shutter sensor hardware and measurement of the focal plane shutter. The BASIC listing of SHUTTER is given in listing 1.

The first function, Monitor, allows the user to measure the distance between the two velocity phototransistors, joystick I/O bits #0 and #2. With an accurate scale mounted to the sensor, a straight edge is manually moved in the same direction as the focal plane shutter. As the first phototransistor is uncovered, bit #0 goes low; call this location on the scale D1. Move the screen toward the left until the third phototransistor is uncovered and bit #2 goes low; call this location on the scale D2. The absolute value of D2-D1 is the calibration distance, CDIST, initialized in line number 1250 of SHUTTER. This value was measured as 24.64 mm on my specific sensor. Modify line 1250 as necessary for your own SHUTTER sensor hardware. The monitor function is exited by pressing any key except BREAK.

The other two functions utilize a statistical sample of ten shutter releases, performed by the subroutine in lines 9000 to 9320. This subroutine computes the average, the standard deviation, and the normalized standard deviation. The normalized standard deviation, NSD, is defined as

$$NSD = (SD/AVE) * 100$$

The NSD is used to compare the consistency of one shutter speed to another. The sample subroutine rounds the measured times to the nearest hundredth of a millisecond. All times are

### Listing 1 (continued)

```
10601 REM ... ADD HEX VALUE OF ASCII
10602 REM ... "V" TO BYTE.
10603 REM
10610 IF V<58 THEN BYTE=BYTE*16+V-48
10620 IF V>57 THEN BYTE=BYTE*16+V-55
10630 SOUND 0,BYTE,10,8
10640 RETURN
10700 REM
10701 REM --- U S R   D A T A
10702 REM
10705 DATA 1536
10710 DATA 68,68,85,CC,68,85,CB
10715 DATA 68,68,85,CD,68,68,68,85,CE
10720 DATA A9,00,8D,2F,02,A5,14
10725 DATA C5,14,F0,FC,A9,20
10730 DATA 8D,0E,D4,A9,00,85,D4
10735 DATA 85,D5,A0,00,B1,CB
10740 DATA 25,CD,D0,FA
10745 DATA 18,A5,D4,69,01,85,D4
10750 DATA A5,D5,69,00,85,D5,B0,0E
10755 DATA A6,CE,F0,04,CA,D0,FD
10760 DATA EA,B1,CB,25,CD,F0,E3
10765 DATA A9,60,8D,0E,D4
10770 DATA A9,22,8D,2F,02,60
10775 DATA **
10800 DATA 1664
10805 DATA 68,68,85,CC,68,85,CB
10810 DATA 68,68,85,CD,68,68,85,CF,68,68,85,CE
10815 DATA A9,00,8D,2F,02,A5,14
10820 DATA C5,14,F0,FC,A9,20
10825 DATA 8D,0E,D4,A9,00,85,D4
10830 DATA 85,D5,A0,00,B1,CB
10835 DATA 25,CD,D0,FA
10840 DATA 18,A5,D4,69,01,85,D4
10845 DATA A5,D5,69,00,85,D5,B0,0E
10850 DATA A6,CE,F0,04,CA,D0,FD
10855 DATA EA,B1,CB,25,CF,D0,E3
10860 DATA A9,60,8D,0E,D4
10865 DATA A9,22,8D,2F,02,60
10870 DATA **
```

### Listing 2

```
0100 ; VELOCITY USR FUNCTION
0110 ; (LISTING #2)
0120 ;
0130 ;
0140 ;
0150 ; This function measures the time
0160 ; that a shutter takes to travel
0170 ; between the velocity phototransistors.
0180 ;
0190 ; Call the Velocity Function by:
0200 ;
0210 ; X=USR(1664,PORT,MASK1,MASK2,DELAY)
0220 ;
0230 ; where
0240 ;
0250 ; PORT - The I/O port address
0260 ; MASK1 - "AND" mask to isolate
0270 ; the first sensor
0280 ; MASK2 - "AND" mask to isolate
0290 ; the second sensor
0300 ; DELAY - for the delay loop.
0310 ;
0315 ;
0320 ; Velocity performs the following:
0330 ;
0340 ; Initialize the variables
0350 ; Disable the Video DMA
0360 ; Disable the Real Time Clock interrupt
0370 ; Initialize the "timer", COUNT
0380 ; Wait until (PORT AND MASK1) = 0
0390 ; DOUNTIL (PORT AND MASK2) = 0
0400 ; Increment COUNT by one
0410 ; Wait in WAITLP DELAY times
0420 ; ENDDO
0430 ; Enable the Real Time Clock
0440 ; Enable the Video DMA
0450 ; Return the value COUNT
0460 ;
0470 ; The actual time of the DOUNTIL
0480 ; loop is 37+5*DELAY machine
0490 ; cycles. With DELAY=0 and the
0500 ; Atari 800 running at 1.79 MHZ,
0510 ; each loop represents about
0520 ; 20.67 microseconds.
```



## Listing 2 (continued)

```

0530 ;
0540 ;::::::::::::::::::::::::::::::::::
0550 ;
0560 ; DEFINE THE VARIABLES USED
0570 ;
00CB 0580 PORT = $00CB STORAGE FOR THE PORT ADDR
00CD 0590 MASK1 = $00CD FOR FIRST SENSOR
00CF 0600 MASK2 = $00CF FOR SECOND SENSOR
00CE 0610 DELAY = $00CE FOR DELAY FACTOR
00D4 0620 COUNT = $00D4 USR RETURN VALUE
0014 0630 RTC = $0014 REAL TIME CLOCK
022F 0640 SDMACT = $022F DMA CONTROL SHADOW REGISTER
D40E 0650 NMIIEN = $D40E NMI INTERRUPT ENABLE REGISTER
0660 ;
0670 ;
0680 ;::::::::::::::::::::::::::::::::::
0690 ;
0700 ;
0000 0710 *= $0680 DEFINE START IN FREE RAM
0711 ;
0712 ; INITIALIZE USR VARIABLES
0720 ;
0680 68 0730 VEL PLA NUMBER OF ARGUMENTS
0681 68 0740 PLA FIRST USR ARGUMENT
0682 85CC 0750 STA PORT+1 MSB OF PORT ADDRESS
0684 68 0760 PLA
0685 85CB 0770 STA PORT LSB
0687 68 0780 PLA SECOND USR ARGUMENT
0688 68 0790 PLA ONE BYTE ONLY
0689 85CD 0800 STA MASK1 FOR FIRST SENSOR
068B 68 0810 PLA THIRD USR ARGUMENT
068C 68 0820 PLA ONE BYTE ONLY
068D 85CF 0830 STA MASK2 FOR SECOND SENSOR
068F 68 0840 PLA FOURTH USR ARGUMENT
0690 68 0850 PLA ONE BYTE ONLY
0691 85CE 0860 STA DELAY DELAY LOOP CONSTANT
0870 ;
0880 ; DISABLE THE VIDEO DMA
0890 ;
0693 A900 0900 LDA #$00
0695 8D2F02 0910 STA SDMACT CLEAR SHADOW REGISTER
0698 A514 0920 LDA RTC WAIT UNTIL VBLANK SETS HARDWARE
069A C514 0930 TICK CMP RTC VBLANK UPDATES CLOCK
069C F0FC 0940 BEQ TICK VBLANK HAS NOT YET OCCURRED
0950 ;
0960 ; DMA SHUT DOWN, TURN OFF VBLANK
0970 ; INTERRUPT.
0980 ;
069E A920 0990 LDA #$20
06A0 8D0ED4 1000 STA NMIIEN DISABLE NMI
1010 ;
1020 ; INITIALIZE THE LOOP COUNTER
1030 ;
06A3 A900 1040 LDA #$00
06A5 85D4 1050 STA COUNT THIS IS THE USR LOCATION
06A7 85D5 1060 STA COUNT+1 TO RETURN A VALUE
1070 ;
1080 ; WAIT UNTIL FIRST SENSOR GOES LOW --
1090 ; I.E. THE CURTAIN UNCOVERS IT
1100 ;
06A9 A000 1110 LDY #$00 FOR INDIRECT INDEXED MODE
06AB B1CB 1120 SENS1 LDA (PORT),Y GET I/O PORT
06AD 25CD 1130 AND MASK1 ISOLATE FIRST SENSOR
06AF D0FA 1140 BNE SENS1 NO LIGHT YET
1150 ;
1160 ; MAIN TIMING LOOP
1170 ;
06B1 18 1180 TIME CLC COUNT THIS TIME IN THE LOOP
06B2 ASD4 1190 LDA COUNT INCREMENT THE LOOP COUNTER
06B4 6901 1200 ADC #$01 LSB
06B6 85D4 1210 STA COUNT
06B8 ASD5 1220 LDA COUNT+1
06BA 6900 1230 ADC #$00 MSB
06BC 85D5 1240 STA COUNT+1
06BE B00E 1250 BCS RET TOO LONG ERROR
06C0 A6CE 1260 LDY DELAY DELAY IF NEEDED
06C2 F004 1270 BEQ SENS2 NO DELAY USED
06C4 CA 1280 WAITLP DEX WAIT A SMALL BIT
06C5 D0FD 1290 BNE WAITLP
06C7 EA 1300 NOP ADJUST TIMING
06C8 B1CB 1310 SENS2 LDA (PORT),Y CHECK SECOND SENSOR
06CA 25CF 1320 AND MASK2 ISOLATE BIT
06CC D0E3 1330 BNE TIME STILL IN THE DARK
1340 ;
1350 ; COUNT CONTAINS THE NUMBER OF TIMES

```

(continued)

corrected by the current value of the variable ERROR.

Both functions use an identical timing loop written at the assembler level and entered as machine code. This loop has a time resolution of  $37 + 5 \cdot \text{DELAY}$  cycles. For the purposes of this article, the variable DELAY was set to zero. Thus, every unit of time counted by the USR functions represents 37 machine cycles. Since the Atari 800 runs with a clock frequency of 1.79 MHz this loop has a resolution of 20.67 microseconds. To accurately use the timing loop, all video Direct Memory Access (DMA) and Atari operating system interrupts must be disabled. For a complete explanation, refer to my previous article "A/D Conversion Using a 555 Timer IC," MICRO 52:14, as well as the manuals *Atari Operating System User's Manual* and *Atari Hardware Manual*.

The second function of SHUTTER, Velocity, allows the user to measure the velocity of the focal plane shutter curtain and compute the value of ERROR. The Velocity function uses the calibration distance, CDIST, which

## TIRED OF TYPING? MICRO has the solution.

Order a diskette of three recent utility programs for the Apple. For only \$10.00, plus \$2.00 shipping and handling, you will receive a DOS 3.3 diskette containing the assembled listings of:

*Applesoft Variable Dump* by Philippe Francois (MICRO, April 1982)

*Straightforward Garbage Collection for the Apple* by Cornelis Bongers (MICRO, August 1982)

*COMPRESS* by Barton Bauers (MICRO, October, 1982)

Please send check, money order, or VISA or MasterCard number. Only prepaid orders accepted. If you missed the above issues of MICRO they can be ordered now! Include \$2.50 for each issue.

Send orders to:

**Apple Utility Disk**  
**MICRO, P.O. Box 6502,**  
**Chelmsford, MA 01824**

was measured with the aid of the Monitor function. Velocity prompts for the size of the light-sensitive area of the shutter phototransistor, bit #1 — in my case, 0.5 mm. After the ten shutter releases, the average time between the two velocity phototransistors, AVE, is used to compute ERROR. In my camera, the shutter curtain took 9.24 ms to travel the 24.64 mm of CDIST. With a detector WIDTH of 0.5 mm, the following proportion holds true:

$$\frac{9.24 \text{ ms}}{24.64 \text{ mm}} = \frac{\text{ERROR ms}}{0.5 \text{ mm}}$$

Solving for ERROR yields:

$$\text{ERROR} = ((9.24 \text{ ms}) \cdot (0.5 \text{ mm})) / 24.64 \text{ mm} = 0.19 \text{ ms}$$

The Velocity function uses the Atari USR function of listing 2.

The third function of SHUTTER, Shutter, allows the user to measure the shutter exposure in milliseconds and to

### How to run a listing in MICRO's Software/Hardware Catalogs

The Software and Hardware Catalogs are provided as a service both to our readers and to the manufacturers. These entries are not MICRO reviews, but descriptions provided by the manufacturer.

To run a free listing in either catalog, a company fills out the appropriate form or merely mails in their material in the same format that appears in the magazine.

We try to limit entries to one company per month, on a first-come-first-serve basis.

If you sell products our readers should know about, write to Software/Hardware Catalog, MICRO, P.O. Box 6502, Chelmsford, MA 01824

### Listing 2 (continued)

```

1360 ; THAT THE TIME LOOP WAS EXECUTED.
1370 ; THIS WILL BE RETURNED BY THE USR
1380 ; FUNCTION
1390 ;
1400 ; ENABLE DMA AND INTERRUPTS
1410 ;
06CE A960 1420 RET     LDA  ##60
06D0 BD0ED4 1430     STA  NMIEN      RESTORE REAL TIME CLOCK
06D3 A922 1440     LDA  ##22
06D5 BD2F02 1450     STA  SDMACT   RESTORE THE VIDEO SCREEN
06D8 60 1460     RTS          RETURN THE COUNT
06D9 1470     .END
    
```

### Listing 3

```

0100 ; SHUTTER USR FUNCTION
0110 ; (LISTING #3)
0120 ;
0130 ;
0140 ; This USR function measures the
0150 ; number of SAMPLE loops that are
0160 ; executed while the phototransistor
0170 ; line is low. Since each SAMPLE
0180 ; loop takes 37+5*DELAY machine
0190 ; cycles to execute, the USR routine
0200 ; measures actual time.
0210 ;
0220 ; Call the USR function by:
0230 ;
0240 ; X=USR(1536,PORT,MASK1,MASK2,DELAY)
0250 ;
0260 ; where:
0270 ;
0280 ; PORT - The address of the I/O port
0290 ; MASK1 - To isolate the phototransistor
0300 ; sensor line
0310 ; MASK2 - Not used (Velocity uses
0320 ; this argument)
0330 ; DELAY - Delay loop variable
0340 ;
0350 ;
0360 ;
0370 ; The Shutter USR function performs
0380 ; the following steps:
0390 ;
0400 ; Initialize the USR variables
0410 ; Turn off the Video DMA
0420 ; Turn off the Real Time Clock
0430 ; Initialize the loop counter, COUNT
0440 ; Wait for the sensor line to go low
0450 ; DOUNTIL the sensor line goes high
0460 ; COUNT this time thru the SAMPLE loop
0470 ; Delay for DELAY number of WAITLPS
0480 ; ENDDO
0490 ; Enable the Real Time Clock
0500 ; Enable the Video DMA
0510 ; RETURN the COUNT
0520 ;
0530 ;
0540 ;::::::::::::::::::::::::::::::::::
0550 ;
0560 ;
0570 ; VARIABLE STORAGE LOCATIONS
0580 ;
0590 ;
0600 PORT = $00CB FOR PORT ADDRESS
0610 MASK1 = $00CD TO ISOLATE SENSOR LINE
0620 DELAY = $00CE DELAY VARIABLE
0630 COUNT = $00D4 LOOP COUNT
0640 RTC = $0014 REAL TIME CLOCK (LSB)
0650 SDMACT = $022F DMA SHADOW REGISTER
0660 NMIEN = $D40E NMI ENABLE REGISTER
0670 ;
0680 ;
0690 ;::::::::::::::::::::::::::::::::::
0700 ;
0710 ;
0000 0720 *= $0600 FREE ATARI MEMORY
0730 ;
0740 ;
0750 ; INITIALIZE THE VARIABLES
0760 ;
0770 SHUTTER
0600 68 0780 PLA NUMBER OF USR ARGUMENTS
0601 68 0790 PLA USR ARGUMENT # 1
0602 85CC 0800 STA PORT+1 ADDRESS OF I/O PORT
0604 68 0810 PLA
0605 85CB 0820 STA PORT
    
```

Listing 3 (continued)

```

0607 68      0830      PLA          USR ARGUMENT # 2
0608 68      0840      PLA          ONLY ONE BYTE
0609 85CD    0850      STA MASK1   "AND" MASK FOR SENSOR LINE
060B 68      0860      PLA          USR ARGUMENT # 3
060C 68      0870      PLA          -- NOT USED
060D 68      0880      PLA          USR ARGUMENT # 4
060E 68      0890      PLA          ONLY ONE BYTE
060F 85CE    0900      STA DELAY   DELAY LOOP VARIABLE
          0910 ;
          0920 ; DISABLE VIDEO DMA AND RTC
          0930 ;
0611 A900    0940      LDA ##00
0613 8D2F02 0950      STA SDMACT TURN OFF SHADOW REGISTER
0616 A514    0960      LDA RTC     VBLANK WILL SHUT OFF HARDWARE
0618 C514    0970      TICK CMP RTC  WAIT TILL VBLANK EXECUTES
061A F0FC    0980      BEQ TICK    NOT YET
          0990 ;
061C A920    1000      LDA ##20    SHUT OFF REAL TIME CLOCK
061E 8D0ED4 1010      STA NMIEN   (STOP VBLANK INTERRUPT)
          1020 ;
          1030 ; INITIALIZE LOOP COUNTER
          1040 ;
          1050 ; NOTE: THIS VARIABLE IS THE ADDRESS
          1060 ; OF THE 16 BIT VALUE RETURNED BY
          1070 ; THE USR FUNCTION.
          1080 ;
0621 A900    1090      LDA ##00
0623 85D4    1100      STA COUNT   A VALUE OF ZERO => ERROR
0625 85D5    1110      STA COUNT+1
          1120 ;
          1130 ; WAIT UNTIL SHUTTER UNCOVERS THE
          1140 ; PHOTOTRANSISTOR.
          1150 ;
0627 A000    1160      LDY ##00    FOR INDIRECT INDEXED MODE
0629 B1CB    1170      SENSOR LDA (PORT),Y GET I/O PORT
062B 25CD    1180      AND MASK1   ISOLATE THE SENSOR LINE
062D D0FA    1190      BNE SENSOR  STILL IN THE DARK
          1200 ;
          1210 ; MEASURE THE SHUTTER TIME
          1220 ;
062F 18      1230      SAMPLE CLC  COUNT THIS LOOP
0630 ASD4    1240      LDA COUNT
0632 6901    1250      ADC ##01
0634 85D4    1260      STA COUNT
0636 ASD5    1270      LDA COUNT+1
0638 6900    1280      ADC ##00
063A 85D5    1290      STA COUNT+1
063C B00E    1300      BCS RET     PULSE TOO LONG -- RETURN ZERO
063E A6CE    1310      LDX DELAY   GET DELAY VALUE
0640 F004    1320      BEQ GETIO   NO DELAY NEEDED
0642 CA      1330      WAITLP DEX  DELAY FOR LONG PULSES
0643 D0FD    1340      BNE WAITLP  WAIT SOME MORE
0645 EA      1350      NOP         ADJUST TIMING
0646 B1CB    1360      GETIO LDA (PORT),Y GET I/O PORT
0648 25CD    1370      AND MASK1   ISOLATE SENSOR
064A F0E3    1380      BEQ SAMPLE  SHUTTER STILL OPEN
          1390 ;
          1400 ; RESET ATARI
          1410 ;
064C A960    1420      RET
064E 8D0ED4 1430      STA NMIEN   ENABLE REAL TIME CLOCK
0651 A922    1440      LDA ##22
0653 8D2F02 1450      STA SDMACT  ENABLE VIDEO DMA
0656 60      1460      RTS         RETURN COUNT
0657        1470      .END
    
```

Table 1: Results of SHUTTER

Shutter Speed (Seconds)	Expected Time (ms)	Measured Time (ms)	Standard Deviation (ms)	Normalized Standard Deviation	Relative Error
1/1000	1.00	1.122	0.048	4.263	-12.2%
1/500	2.00	2.268	0.050	2.208	-13.4%
1/250	4.00	4.359	0.067	1.543	-9.0%
1/125	8.00	8.516	0.037	0.429	-6.5%
1/60	16.67	16.842	0.029	0.172	-1.0%
1/30	33.33	33.276	0.106	0.319	0.2%
1/15	66.67	61.987	1.885	3.041	7.0%
1/8	125.00	126.595	2.652	2.095	-1.3%
1/4	250.00	269.122	3.855	1.432	-7.6%
1/2	500.00	534.875	4.295	0.803	-7.0%
1	1000.00	1024.093	4.841	0.473	-2.4%

compute the relative error. Since the Shutter function uses the current value of ERROR to correct for the sensor width, the Velocity function must be run prior to the first shutter measurement. (As my camera had a constant curtain speed, only one Velocity function needed to be performed.) The Shutter function prompts for the expected exposure time in milliseconds. After the ten shutter releases, the average value is used to compute the relative error from the expected value. This function utilizes the Atari USR function of listing 3.

Results

The results of SHUTTER as applied to my camera are presented in table 1. As expected, several shutter speeds have rather large relative errors. However, keep in mind that errors as large as 33% (1/3 of an f/stop) are often visually acceptable. Thus, with all shutter errors below 15%, this particular camera is reasonably accurate. Notice that the shutter yields excellent accuracy for 1/60th and 1/30th of a second, two commonly used shutter speeds.

The criteria of consistency is measured by the normalized standard deviation, NSD. All shutter speeds are within 5% consistency with individual bests again going to 1/60th and 1/30th of a second shutter speeds. Over one half of the shutter speeds are consistent to within a 2% NSD. The mechanical consistency of my camera shutter seems to be very good.

In conclusion, my camera passes the SHUTTER test in good condition. The highest shutter speeds and the seldom used 1/4th and 1/2 of a second speeds slightly overexpose the film. Only the 1/15th of a second shutter speed, used for special effects with water subjects, underexposes the film. Since the consistency is excellent, these slight exposure errors may be easily corrected by adjusting the camera lens aperture.

Mike Dougherty works at Martin Marietta Aerospace in Denver, CO. His home-based system presently consists of an Atari 800 with 24K bytes of memory, the Atari 410 recorder, and the Atari 850 Interface Module for future communication with single-board computers. You may contact him at 7659 W. Fremont Ave., Littleton, CO 80123.



# It's All Relative — Using CBM's Relative Records Part 2

by Jim Strasma

**In this second part of his series, Contributing Editor Jim Strasma discusses how to set up relative files and records.**

The first article of this series (MICRO 55:37) explained a variety of techniques useful for setting up a program package that uses relative files. In this installment I create a relative file. If you have Chris Bennett's "Mail List 4040," you may want to have it handy as you read.

In part 1, I discussed how to set up most variables needed by the mail list and how to prepare to chain between the various program modules. After the setup module finishes, it chains to a short program called "4040 menu." This serves two functions: to separate the menu, ensuring that the setup module is run only once per use (all other modules chain to and from the menu), and to make sure the menu is short enough to load quickly, as it is called often.

Before you create a relative file, there are two features in the "4040 menu" that you may want to add to other programs. First there is a safety line:

```
1020 IF DI=0 THEN END: REM Guard
      against cold start here
```

If you were to begin the program at the menu rather than at the setup module, the preset variables would be incorrect and the package would fail. Line 1020 ensures that the program will halt if the module begins with variables cleared.

The other menu feature is an undocumented command. When the menu appears no mention is made of a format module, even though it is callable from the menu. The format module was omitted to protect against accidentally erasing data.

To create a relative file, select the unwritten menu option 3. This loads the program "4040 format," which creates the files needed by the mail-list package. Because the user could get here by hitting the wrong key at the menu, this module begins with its own menu, limited to either returning to the main menu or formatting a new data disk. If the user elects to continue, he is asked to provide a name for the data diskette, which is then completely formatted. The format command in Commodore BASIC 4.0 is HEADER, as seen in line 1240:

```
1240 HEADER D(DD), (F$),IML ON
      U(UN)
```

The BASIC 2 equivalent, also used by VIC and the CBM 64, is:

```
1240 OPEN 15,UN,15
1241 PRINT#15,"N"+MID$(STR$(
      (DD),2)+F$+" ,ML"
1242 CLOSE 15
```

Notice that the diskette ID number "ML" is not preset by the setup module. BASIC 4.0 does not allow the ID to be a variable. You may alter it, but only by changing line 1240.

In BASIC 2 you could predefine the ID as ID\$ in the setup module. Then, instead of ending line 1241 with '+",ML"', you would end it with '+",'+ID\$'. While you are at it, preset the program and data drive numbers as string variables to avoid constantly referring to them as 'MID\$(STR\$(drive needed),2)'. I also suggest opening the disk-error channel in the setup module and leaving it open throughout the package since it is used often. To do this, leave out lines 1240 and 1242 above and change line 1241 to 1240.

Several chores within the mail list are handled in machine language. One of the most important of these is user input. Using the ordinary INPUT command of BASIC, it is fairly simple for a user to foul up data by hitting the wrong keys. The mail list prevents this by monitoring the keys as they are hit and excluding those which could cause trouble. The first time the user encounters this new input is in line 1180:

```
1180 SYS IN,64,16,1$
```

This line displays a row of 16 asterisks on the screen, with the leftmost one flashing rapidly. This area is the input field, and users are forced to remain within it until they hit [return]. The 64 is a mask to indicate which characters are allowed in the input. The response is placed in the variable L\$. Parameters for the input follow the SYS command. If SYS were left out, the line would cause a SYNTAX ERROR. Fortunately, the machine-language module reads the extra characters and ups the BASIC text pointer so BASIC never sees the illegal syntax. In part 6 of this series, I will explain how this is done and suggest changes for those with BASIC 2.

Meanwhile, those without BASIC 4 may substitute an INPUT statement:

```
1180 INPUT 1$
1181 IF LEN(1$) > 16 THEN ?"[UP]";
      :GOTO 1180
```

The CURSOR UP returns overlong inputs to the original line to be redone.

As soon as the diskette is formatted (about a 20-second process on a 4040 drive) the relative file is created by line 1260:

```
1260 DOPEN#1,(F$),D(DD),L(RL)
      ON U(UN)
```

The L parameter tells DOS that this is a relative file. If the file already exists, it will be opened for use. However, if the file on the diskette has a different value for L than line 1260, a DOS error will result. To prevent any possibility of this, line 1260 is the only place in the mail list where L is set. Everywhere else the value stored by the disk is used. This shortens the program slightly but, more important, it eliminates a potential error.

The value RL contains the desired record length for the file, preset by the setup module. Currently, it is set at 150 characters, including all carriage-return characters. This is not enough to allow the user to fill every field in the record to its maximum length. However, this is rarely a problem since only the part of each field actually used is added to the record length, along with a leading quotation mark and a trailing carriage return. Most addresses can be written easily in under 150 characters, leaving room on the diskette for more records.

If the concept of files, records, and fields is new to you, think of a common 3" x 5" card-file box. The entire box of cards is the file, each card within the

box is one record, and each line on a single card is a field. It works the same way on the computer, except that the cards and box are no longer visible.

For those with BASIC 2, the equivalent of line 1260 is:

```
1260 OPEN 1,UN,2,MID$(STR$(DD),2)
      + ":" + F$ + ",1" + CHR$(RL)
```

The secondary address, 2, is of no great significance here. Just be sure you don't assign the same secondary address to disk files that could be opened simultaneously. Note the use of CHR\$ to send the record length.

In order for the relative file to work reliably, it is necessary to create the needed records in advance. DOS is able to append new records to the end of a relative file later, but initializing all that are likely to be needed at once avoids some errors, including the possibility of filling the disk. It also ensures that the file will use at least two sectors on the diskette, a necessity for updating file data properly.

Line 1280 defines the maximum record:

```
1280 RECORD#1,(NR)
```

Or, in BASIC 2.0,

```
1280 OPEN 15,UN,15
1281 B2 = INT(RL/256)
1282 BL = RL - 256*B2
1283 PRINT#15,"P" + CHR$(2) + CHR$(
      (BL) + CHR$(BH) + CHR$(1)
```

Note that the 2 in CHR\$(2) must be the same as the secondary address set in line 1260. B2 and B1 are temporary variables that contain the high- and low-byte values of the number in RL. CHR\$(1) tells DOS to point at the first byte within record #RL. If line 1280 in BASIC 4 were changed to

```
1280 RECORD#1,(NR),8
```

then we would use CHR\$(8) instead for BASIC 2. In that case, both BASICs would begin to access data at byte number 8 within the record. This option is rarely used.

If record #NR already exists, line 1280 takes only a moment. Here, however, record #NR first has to be created. DOS indicates this by sending a disk status of 50. This is not usually an error, but needs to be handled separately as most disk error-checking lines will

## SIG-FORTH V 1.0

The only stand-alone Forth system  
for O.S.I. serial machines

### Features:

- Complete Forth source code
- Advanced Screen editor w/source
- 6502 macro assembler w/source
- Double number and CASE extensions
- Vectored boot capability
- Several Utility Screens
- Complete glossary

### Dos Includes:

- Bi-Directional NEC driver
- 65U read capability
- NMHZ Capability

**\$100.00**  
POSTAGE PAID

**DIGI COM ENGINEERING, INC.**

P.O. Box 1656  
Kodiak, Alaska 99615

ORDERING INFORMATION: Check, money order or C.O.D.'s accepted.  
Shipment VIA first class mail. Allow approximately one week for delivery.



PREMIER  
ISSUE

DECEMBER 1, 1982

Commander

THE MONTHLY JOURNAL FOR  
COMMODORE  
COMPUTER USERS

VIC - 20

64

PET/CBM

MAX MACHINE

"COMMANDER will be dedicated to communicating the fun of, as well as the latest information about the COMMODORE COMPUTERS."

### GET YOUR MONEY'S WORTH

You've probably made a sizeable investment in your computer equipment. COMMANDER can help you make the most of it. Each issue brings you the no-nonsense advice you need to stay on the leading edge of this constantly changing field. COMMANDER will be your reference source to the world of computers with the best, most comprehensive coverage you can get!!

PREMIER ISSUE     1 YR. \$22     2 YR. \$40     3 YR. \$56  
(PRICES DO NOT INCLUDE \$4 DISCOUNT)

\$4 DISCOUNT

— Subscription Orders Only —  
Toll Free Number: 1-800-426-1830  
(except WA, HI, AK)

COMMANDER  
P.O. BOX 98827  
TACOMA, WASHINGTON 98498  
(206) 565-6818



## PROFESSIONAL WORD PROCESSOR

- ✓ Double Columns
- ✓ Page by Paragraph
- ✓ Right Justification
- ✓ Line Centering
- ✓ Printer Graphics
- ✓ Shorthand
- ✓ Variable Line Space
- ✓ Margin Control
- ✓ Printer Control Code
- ✓ Form Letters

FOR APPLE/PET/CBM  
**COPY-WRITER** by IDPC Co.  
 only \$185.00

## EXCHANGE DATA w IBM 3740

**PEDISK II 877 FLOPPY DISK** Systems can now read and write records from IBM "Basic Data Exchange" type diskettes. FILEX software from WILSERVE does all the work! Converts EBCDIC - ASCII.

- EXCHANGE System (877/FILEX) ..... \$1295.
  - PEDISK 877-1 8" Floppy for PET..... \$ 995.
  - PEDISK 540-1 5" Floppy for PET..... \$ 595.
  - CONTROLLER BOARD w PDOS..... \$ 229.
- PEDISK II is a high performance floppy disk system designed for the Commodore PET/CBM, Rockwell AIM and Synertek SYM. It features high performance, simple reliable design and IBM format.

- SOFTWARE FOR PEDISK II
- COPYWRITER Pro Word Processor ..... \$185.
  - MAE Macro Assembler Editor by EHS ..... \$170.
  - FLEXFILE II Data Base Manager ..... \$ 80.
  - PAPERMATE Word Processor ..... \$ 60.
  - DISK UTILITY PACK ..... \$ 25.
  - FASTFILE Data Base ..... \$100.
  - FILEX IBM Access Routines ..... \$245.
  - MENU LOAD ..... \$ 10.
  - fullFORTH+ ..... \$100.

## Commodore Communicates! COMPACK \$129.

Intelligent Terminal Package including: ACIA based interface  
 DB25 cable  
 STCP software

- ✓ Remote Telemetry
- ✓ XON-XOFF Control
- ✓ Transfer to/tr Disk
- ✓ User Program Cntl
- ✓ Printer Output
- ✓ Status Line

## \$139 COLOR CHART

AIM/SYM system video display, 64 x 16 characters, 8 colors, plugs into ROM socket, 4K RAM Multiple modes; semi graphics, alpha.

PET/CBM color graphic display, 128 x 192 pixels, generate color bar graphs on one screen with data on main screen. RS170 video color chart. 6847 based video output.

## COLOR VIDEO FOR PET/CBM/AIM/SYM

## ROMSWITCH - 4 ROMS IN 1 SPACEMAKER \$39.95

Switch 4 ROMs into the same socket. A slide switch activates one of four. Electronic controls insure no glitches and allow ROM switching under software control. ROMs can be switched from the keyboard.

## fullFORTH+ for APPLE/PET

FULL FIG FORTH implementation plus conditional assembler, floating point, string handling, multi-dimensional arrays, and disk virtual mamory

- fullFORTH+ from IDPC Co ..... \$100
- Target Compiler ..... \$ 50

SEE YOUR DEALER OR:

**MICROTECH**

P.O. Box 102  
 Langhorne, Pa. 19047  
 215-757-0284

DEALER INQUIRIES INVITED

consider it an error. Line 1290 does it this way:

```
1290 IF DS < > 50 THEN 1510
```

If this is the first time record #NR is created, even a disk status of 0 would be an error for these purposes. If you are using BASIC 2, it is easier to put the disk status check into a single subroutine. Here is a simple example:

```
60000 REM Check disk status
60010 OPEN 15,UN,15
60020 INPUT#15,DS,DS$,ET,ES
60030 CLOSE 15
60040 RETURN
```

If you choose to use this subroutine add it to each module in the mail list. Then call it at the start of each disk error-check line in the package. Line 1290 in this module becomes:

```
1290 GOSUB 60000:IF DS < > 50
    THEN 1510
```

Note that this subroutine cannot be used by those with BASIC 4, as the variables DS and DS\$ are reserved for this purpose by BASIC itself.

The next task is to write to the last record of the file. This forces BASIC to create all the records up to and including the last file. When records are newly created they are filled with CHR\$(255), the Pi character. This character has a special advantage: when read from the disk it flashes the EOI line of the IEEE bus, signaling to BASIC that the entire record has now been sent from the disk. You can take advantage of this in line 1300 by writing the record with the same character:

```
1300 PRINT#1,PI$:REM Leaves null
```

Normally, writing a record takes only a moment. Here, however, DOS has to first create all the records up to and including number NR and fill them with dummy data. In the standard mail list this function takes about three minutes and creates 1000 records. After completion, the file may be closed:

```
1310 DCLOSE ON U(UN)
```

DCLOSE without a file number closes all disk files on the named unit (on unit 8 if no unit is given). In BASIC 2 the file

must be closed by number with:

```
1310 CLOSE 1
```

This concludes the relative-file portion of "4040 header." There are still two other files to be created. These are sequential-index files, which help the mail list find records in the relative file by name rather than number. In BASIC 4 this is done with:

```
1320 DOPEN#1,D(DD),"INDEX",W
    ON U(UN)
```

In BASIC 2 it becomes:

```
1320 OPEN 1,UN,3,MID$(STR$
    (DD),2) + ":INDEX,S,W"
```

with a similar change in line 1370. Remember also that in BASIC 2 you must end each PRINT# statement to the disk with CHR\$(13) and a semi-colon; otherwise a linefeed will also be sent to the disk, causing havoc when the file is read. C\$ is preset to CHR\$(13), so line 1300 becomes:

```
1300 PRINT#1,PI$C$;REM Leaves null
```

Finally, SYS PA in line 1540 cleans up the stack pointer, erasing all open FOR...NEXT loops and active subroutines. Normally you would not want to do this. However, when chaining, the stack has less chance than usual to clean itself. Without SYS, repeated errors might cause a stack-related OUT OF MEMORY ERROR that would halt the program. If you are not using BASIC 4, choose the correct PA address below and substitute it in the setup module.

### Panic Address on Commodore Machines

BASIC 4	\$B612	46610
BASIC 2	\$C597	50583
BASIC 1	\$C588	50568
VIC	\$C67E	50814
CBM 64	\$A67E	42622

In the next installment of this series, I will look at the largest module in the mail list, the update module, which is responsible for maintaining all the files and data.

You may contact the author at 1280 Richland Ave., Lincoln, IL 62656.

**MICRO**

# NIBBLE EXPRESS Vol. I

## TABLE OF CONTENTS

EDITORIAL ..... 3

APPLE TRAC — Personal Finance Management by Mike I ..... 7

SORT 'EM OUT — Principles of Sorting by NIBBLE Staff ..... 17

PSEUDO UTO-START — Reset with CTRL Y by Rick Con ..... 17

INITIALIZE NEW FILES WITH ONERR GOTO by NIBBLE ..... 18

MACHINE LANGUAGE SCREEN DUMP by R.M. Mottola ..... 18

FREE? DISK SECTORS by Chuck Hartley ..... 19

HI-RES SPACE MAZE — Graphics Game by NIBBLE Staf. .... 22

UN-GRAPHIC GRAPHIC PRINTING by NIBBLE Staff ... 23

TABLE PRINTING MADE SIMPLE! by NIBBLE Staff ..... 24

DYNAMIC ARRAY DIMENSIONING by NIBBLE Staff ..... 26

BLOCKING VERY LARGE FILES by NIBBLE Staff ..... 26

LOW RESOLUTION SHAPEWRITER — High Speed Actio ..... 31

SPACE ANIMATION — Add ZIP to your Games by NIBBL ..... 35

STAR ATTACK — Fast Hi-Res Conflict Game by Mike Hai ..... 37

PADDLE READING IN ASSEMBLY LANGUAGE by NIBBI ..... 38

FIRING HI-RES MISSILES — Aiming and Control by NIBE ..... 39

AIRSEA BATTLE — Join the Air Force Maneuvers b ..... 47

AUTOMATIC TEST CASE CONTROL by NIBBLE Staff ..... 50

WATCH OUT FOR GRAPHICS OVERFLOW by Mike Harv ..... 50

T.O.U.C.H. — Test Operating System by Mike Harvey ... 53

TOUCH SCREEN HARDWARE SIMULATION by William Reyno ..... 58

TOUCH FILE AND REPLACE DITION by William Reyno. .... 59

DOUBLE/TRIPLE/AND MORE OVERPRINTING by NIBBL ..... 59

ARROWS AND CONTROL CODES by NIBBLE Staff ..... 59

APPLE TRICKS — Fast DOS/Spcl Chars/Unlistables by C ..... 60

APPLESOFT VS. INTEGER BASIC PERFORMANCE by A. .... 65

APPLE II — Paper Tiger Graphics by Mike Harvey ..... 69

APPL'S MAIN — Fun Music and Fun by Mike Harvey ..... 73

APPL TOP/AT FILE CONTROL by Alexander Laird ..... 77

APPLESOFT REM REMOVER by Alan D. Floeter ..... 78

FAST FORECASTING AND SALES TRENDING by Mike I ..... 83

SUPERWEAVING — Res Weaving Design by Alexander ..... 89

FOOTBALL — Lo-Res Grid-Iron Action by Lou Haehn ... 93

BUILD DUAL JOYSTICKS FOR UNDER \$15.00 by NIBBL. .... 97

BUILD THE TWO TAPE CONTROL UNIT by NIBBLE Staf ..... 98

DISK AID WITH THE RECTANGLE FUNCTION by NIBBLE ..... 99

APPL TRICKS — CREATING CUSTOMER LIST by Cra ..... 101

PIP I — Personal Inventory Program on Tape by Rick Con ..... 103

FUN WITH ASSEMBLER — The Bomb by Craig Cr ..... 106

PIP II — PIP C's Disc by Mark Capella ..... 113

PASS ON VARIABLES IN PILES OUT BASIC by R.M. M ..... 119

MANAGING AND MOVING DISK BUFFERS by William Re ..... 120

MONITOR EXECUTION — Basically by William Reynolds ..... 121

AMPER-INTERPRETER — Add Print-Using and Much Mo ..... 123

FUN WITH ASSEMBLER — Graphics by Alexander Laird ..... 133

STRING FUNCTION FOR INTEGER BASIC by William Re ..... 135

BASIC/MACHINE LANGUAGE SUBROUTINE CREATOR ..... 135

CHR\$ FUNCTION FOR INTEGER BASIC by William Reyr. .... 135

FUN WITH ASSEMBLER — Alpha/Beeper by Craig Cross ..... 136

APPLE A.I.M. — Automated Intelligent Mailing by Micha ..... 139

APPLE CONCORDANCE — Track Variable and Line #'s b ..... 147

LOW SCORE II — Strategy Game by Rudy A. Guy ..... 153

HOW TO WRITE GAMES THAT LAST by Mike Harvey ... 157

IMPROVING THE MULTIPLE ARRAY SORT by Rick Coni ..... 158

APPLE UPPER/LOWER CASE PRINTING by Mike Harvey ..... 159

WILL O' THE WISP — High Adventure by Mark Capella .. 161

NIFFUM — DOS 3.3 to 3.2 Conversion by C.J. Thompson ..... 169

BLAST AWAY! — Lo-Res Shooting Gallery by Andrew Be. .... 171

FUN WITH MONITOR — How to Enter Assembly Languag ..... 174

# SECOND BRAND NEW PROGRAM LISTINGS!

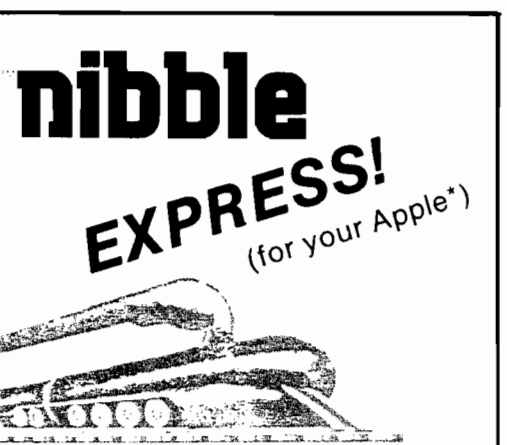

**ORDER NOW**



All programs and Articles are centered on the Apple Computer family.

---

**NIBBLE**  
P.O. Box 325  
Lincoln, MA 01773

Yes! I want NIBBLE EXPRESS Vol. 1 in my library!  
Here's my  Check  Money order  
for \$12.95 plus \$1.75 postage/handling. (Outside U.S. add \$2.75 Surface Mail or \$5.00 Airmail.)

Also send me NIBBLE EXPRESS Vol. 2 at \$14.95 plus \$1.75 postage/handling. (Outside U.S. add \$2.75 Surface Mail or \$5.00 Airmail.)

Master Card & Visa Accepted

Card # \_\_\_\_\_ Expires \_\_\_\_\_  
PLEASE PRINT CLEARLY

Signature \_\_\_\_\_

Telephone \_\_\_\_\_

Name \_\_\_\_\_

Street \_\_\_\_\_

City \_\_\_\_\_ State \_\_\_\_\_ Zip \_\_\_\_\_

Your check or money order must accompany your order to qualify.

Outside U.S.: Checks must be drawn on a U.S. Bank.

\*Apple is a registered trademark of Apple Computer Company.

Page

3

7

17

17

18

18

19

22

23

24

26

26

31

35

37

38

39

47

50

50

53

58

59

59

59

60

65

69

73

77

78

83

89

93

97

98

99

101

103

106

113

119

120

121

123

133

135

135

135

136

139

147

153

157

158

159

161

169

171

174

computer mail order west



400

16K.....\$199  
 32K.....\$274  
 48K.....\$359

410 Recorder.....	\$74.00
610 Disk Drive.....	\$429.00
822 Printer.....	\$269.00
825 Printer.....	\$589.00
830 Modem.....	\$159.00
820 Printer.....	\$259.00
850 Interface.....	\$169.00
CX40 Joysticks (pair).....	\$18.00
CX853 Atari 16K Ram.....	\$77.95

HOME COMPUTERS

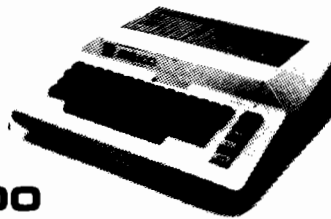

800  
 48K.....\$499

New low price effective January 1, 1983.

Microtek 16K Ram.....	\$74.95
Axlon Ramdisk (128K).....	\$429.95
Intec 48K Board.....	\$159.00
Intek 32K Board.....	\$74.00
One Year Extended Warranty.....	\$70.00
CX481 Entertainer Package.....	\$89.00
CX482 Educator Package.....	\$130.00
CX 483 Programmer Package.....	\$54.00
CX 484 Communicator Package.....	\$344.00

PERCOM

DISK DRIVES FOR ATARI COMPUTERS

S1 Single Drive.....	\$549.00
A1 Add-On Drive.....	\$339.00
S2 Dual Drive.....	\$879.00
Single Side Dual Head.....	\$879.00
Dual Drive Dual Head.....	\$1048.00

µ-SCI

MICRO-SCI DISK DRIVES FOR FRANKLIN & APPL



A2.....	\$299
A40.....	\$369
A70.....	\$499
C2 Controller.....	\$79
C47 Controller.....	\$89

SOFTWARE FOR ATARI

<b>ATARI</b>	
Pac Man.....	\$33
Centipede.....	\$33
Caverns of Mars.....	\$32
Asteroids.....	\$29
Missile Command.....	\$29
Star Raiders.....	\$35
Galaxian.....	\$33
Defender.....	\$33

<b>ON-LINE</b>	
Jawbreaker.....	\$27
Softporn.....	\$27
Wizard & Princess.....	\$29
The Next Step.....	\$34
Mission Asteroid.....	\$22
Mouskattack.....	\$31
Frogger.....	\$31
Cross Fire (ROM).....	\$36

<b>SYNAPSE</b>	
File Manager 800.....	\$89
Chicken.....	\$26
Dodge Racer.....	\$26
Synassembler.....	\$30
Page 6.....	\$19
Shamus.....	\$26
Protector.....	\$26
Nautilus.....	\$26
Slime.....	\$26
Disk Manager.....	\$24

<b>DATASOFT</b>	
Pacific Highway.....	\$25
Canyon Climber.....	\$25
Tumble Bugs.....	\$25
Shooting Arcade.....	\$25
Clowns & Balloons.....	\$25
Graphic Master.....	\$30
Graphic Generator.....	\$13
Micro Painter.....	\$25
Text Wizard.....	\$79
Spell Wizard.....	\$64
Bishop's Square.....	\$25
Sands of Egypt.....	\$25

<b>EPYX</b>	
Crush, Crumble.....	\$24
Undead Crypt.....	\$24
Curse of Ra.....	\$16
Datestones.....	\$16
Invasion Orion.....	\$19
Arthur's Heir.....	\$24
Morloc's Tower.....	\$16
Rescue at Rigel.....	\$24
Ricochet.....	\$16
Star Warrior.....	\$29
Temple Apshei.....	\$29
Upper Reaches.....	\$16

<b>APX</b>	
Text Formatter.....	\$18.50
Family Budget.....	\$18.50
Eastern Front.....	\$24
Family Cash.....	\$18.50
Jukebox.....	\$13
Downhill.....	\$18.50
Outlaw.....	\$18.50
Holy Grail.....	\$24
Player Piano.....	\$18.50
Keyboard Piano.....	\$18.50
Number Blast.....	\$13
Frogmaster.....	\$18.50
747 Land Simul.....	\$18.50
Word Processor.....	\$40

<b>CBS</b>	
K-razy Shoot Out.....	\$32
K-razy Kritters.....	\$32
K-razy Antics.....	\$32
K-star Patrol.....	\$32

STICK STAND

\$6<sup>99</sup>



VISICORP

For Apple, IBM & Franklin

Visidex.....	\$189.00
Visifile.....	\$189.00
Visiplot.....	\$159.00
Visiterm.....	\$89.00
Visitrend/Plot.....	\$229.00
VisiSchedule.....	\$229.00
Desktop Plan.....	\$189.00
VISICALC for Apple II plus, Atari, CBM & IBM.....	\$179.00

<b>CONTINENTAL</b>	
The Home Accountant (Apple/Franklin).....	\$59.00
The Home Accountant (IBM).....	\$119.00
1st Class Mail (Apple/Franklin).....	\$59.00

<b>SIRIUS</b>	
Free Fall.....	\$24
Beer Run.....	\$24
Snake Byte.....	\$24
Space Eggs.....	\$24
Sneakers.....	\$24
Bandits.....	\$28

<b>BRODERBUND</b>	
Apple Panic.....	\$23
David's Magic.....	\$27
Star Blazer.....	\$25
Arcade Machine.....	\$34
Choplifter.....	\$27
Serpentine.....	\$27

<b>INFCOM</b>	
Deadline.....	\$35
Star Cross.....	\$29
Zork I.....	\$29
Zork II or III.....	\$29

<b>MPC</b>	
Bubdisk (128K Ram).....	\$719.00

FLOPPY DISKS

<b>MAXELL</b>	
MD I (Box of 10).....	\$32
MD II (Box of 10).....	\$44
MFD I (8").....	\$40
MFD II (8" DD).....	\$50
<b>VERBATUM</b>	
5 1/4" SS DD.....	\$21
5 1/4" DS DD.....	\$31
<b>ELEPHANT</b>	
5 1/4" SS DD.....	\$19.9

MONITORS

<b>AMOEK</b>	
300G.....	\$169.00
Color I.....	\$339.00
Color II.....	\$699.00
Color III.....	\$429.00

<b>BMC</b>	
12" Green.....	\$85.00
13" Color 1400.....	\$279.00
13" Color 1401 (Mid Res).....	\$369.00

<b>ZENITH</b>	
ZVM121.....	\$99.00

<b>SHARP</b>	
Sharp 13" Color TV.....	\$275.00

<b>PANASONIC</b>	
TR-120 MIP (High Res. Green).....	\$159.00
CT-160 Dual Mode Color.....	\$299.00

PRINTERS

<b>Smith Corona</b>	
TP 1.....	\$599.00

<b>C.I.TOH (TEC)</b>	
Starwriter (F10-40CPS).....	\$1399.00
Printmaster (F10-55CPS).....	\$1749.00
Prowriter 80 Col (P).....	\$499.00
Prowriter 80 Col (S).....	\$629.00
Prowriter 2 (132 Col).....	\$799.00

<b>OKI/OATA</b>	
82A.....	\$429.00
83A.....	\$659.00
84P.....	\$1079.00
84S.....	\$1199.00

<b>IDB</b>	
MicroPrism.....	\$649.00
132 (fully configured).....	\$1599.00
80 (fully configured).....	\$1399.00

Call for other configurations.

<b>DAISYWRITER</b>	
Letter Quality.....	\$1049.00

<b>DIABLO</b>	
620.....	\$1179.00
830.....	\$1849.00

MODEMS

<b>HAYES</b>	
Smart.....	\$239.00
Smart 1200 (1200 Baud).....	\$549.00
Chronograph.....	\$199.00
Micromodem II (with Term).....	\$309.00
Micromodem 100.....	\$309.00

<b>NOVATION</b>	
Cat.....	\$144.00
D-Cat.....	\$159.00
Auto Cat.....	\$219.00
212 Auto Cat.....	\$589.00
Apple Cat II.....	\$279.00
212 Apple Cat II.....	\$609.00

<b>ANCHOR</b>	
Mark I (RS-232).....	\$79.00
Mark II (Atari).....	\$79.00
Mark III (TI-99).....	\$109.00
Mark IV (CBM/PET).....	\$125.00
Mark V (OSBORNE).....	\$95.00
Mark VI (IBM-PC).....	\$179.00
Mark VII (Auto Answer Call).....	\$119.00
TRS-80 Color Computer.....	\$99.00
9 Volt Power Supply.....	\$9.00

800-648-3311

west

IN NV. CALL (702) 588-5654

WES

P.O. BOX 6668 STATELINE, NV. 89449

INTERNATIONAL ORDERS: All shipments outside continental United States must be pre-paid by certified check only! Include 3% (minimum \$3.00) shipping and handling. EDUCATIONAL DISCOUNTS: Additional discounts are available from both Computer Mail Order locations to qualified Educational Institutions.

# FRANKLIN ACE 1000 SYSTEM

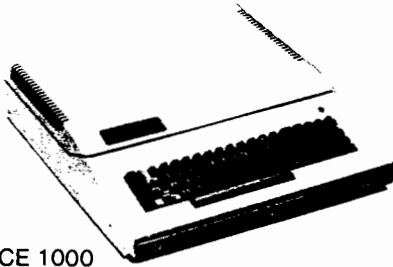

ACE 1000  
ACE 10 with Controller Card  
ACE Writer Word Processor  
**CALL..**  
FOR SYSTEM PRICE.

# IBM®

## PC

NEC  
3550 Printer  
\$2089

**PERCOM DRIVES**  
5 1/4" 180K Disk Drive ..... \$329  
5 1/4" 320K Disk Drive ..... \$449

**AMDEK**  
310A Amber Monitor ..... \$179  
Amdisk(3 1/4") Drive ..... \$729  
DXY Plotter ..... \$759

**SOFTWARE**  
I.U.S. Easywriter II ..... \$249  
I.U.S. Easyspeller ..... \$129  
Peachtree Peach Pak (GL/AP/AR) ..... \$419  
MPC Bubbdisk ..... call



# EAGLE

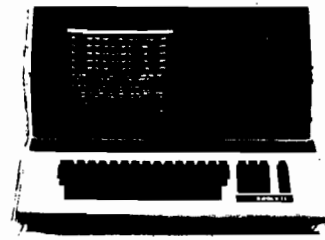

64K RAM  
780 KB Disk Storage  
Word Processing, Ultracalc CP/M  
C-Basic Software  
Smith Corona TP1  
Letter Quality Printer  
**\$2995.00**

Retail Value ..... \$4895.00

## RANA DISK DRIVES

Call for price and availability on the new Rana Disk Drives for the Apple and Franklin Computer Systems

## commodore

8032.....	\$999.00
CBM 64.....	CALL
4032.....	\$749.00
8096 Upgrade Kit.....	\$369.00
Super Pat.....	\$1599.00
2031.....	\$369.00
8250 Double Sided Disk Drive.....	\$1699.00
D9080 5 Megabyte Hard Disk.....	\$2399.00
D9080 7.5 Megabyte Hard Disk.....	\$2699.00
8050.....	\$1299.00
4040.....	\$989.00
8300 (Letter Quality).....	\$1549.00
8023.....	\$599.00
4022.....	\$399.00
New Z-Ram, Adds CP/M and 64K Ram.....	\$549.00
The Manager.....	\$209.00
Magis.....	CALL
Word Pro 5 plus.....	\$319.00
Word Pro 4 plus.....	\$299.00
Word Pro 3 plus.....	\$199.00
The Administrator.....	\$379.00
InfoPro Plus.....	\$219.00
Fover.....	\$79.00
VIC 20 Dust Cover.....	\$6.99
CBM 8032 Dust Cover.....	\$14.99
CBM 8050/4040 Dust Cover.....	\$10.99

## hp HEWLETT PACKARD HP 41CV CALCULATOR

### \$209

HP 41C.....	\$149.00
HP 10C.....	\$69.00
HP 11C.....	\$79.00
HP 12C.....	\$114.00
HP 15C.....	\$109.00
NEW 16C.....	\$114.00

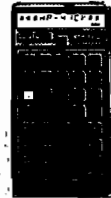

## HEWLETT PACKARD



## HP-85 \$1969



HP-125.....	\$1969.00
HP-85 16K Memory Module.....	\$169.00
5 1/4" Dual Master Disk Drive.....	\$1799.00
Hard Disk w/Floppy.....	\$4349.00
Hard Disk.....	\$3549.00
"Sweet Lips" Printer.....	\$1199.00
80 Column Printer.....	\$649.00



PC-1500  
POCKET  
COMPUTER

### \$209

CE 150 Printer, Plotter and Cassette  
Interface Unit..... \$172.00  
CE152 Cassette Recorder..... \$69.00  
CE 155 8K Ram Expansion Module... \$94.00

## TELEVIDEOD TERMINALS

910.....	\$579.00
912C.....	\$699.00
920C.....	749.00
925C.....	\$749.00
950.....	\$950.00



800A.....	\$1319.00
802.....	\$2649.00
802H.....	\$4695.00
806.....	\$5495.00
816.....	\$9495.00

## VIC 20 \$179



VIC 1530 Commodore Datasette.....	\$69.00
VIC 1540 Disk Drive.....	\$339.00
VIC 1541 (84 Disk Drive).....	CALL
VIC 1525 Graphic Printer.....	\$339.00
VIC 1210 3K Memory Expander.....	\$32.00
VIC 1110 8K Memory Expander.....	\$53.00
VIC 1111 16K Expansion.....	\$94.00
VIC 1011 RS232C Terminal Interface.....	\$43.00
VIC 1112 VIC IEEE-488 Interface.....	\$86.00
VIC 1211 VIC 20 Super Expander.....	\$53.00
VIC Mother Board.....	\$99.00

## Timex Sinclair 1000



### \$89

16K Memory Module.....	\$44.95
Vu-Calc.....	\$17.95
Super Math.....	\$12.95
Check Book Manager.....	\$13.95
Loan & Mortgage Amortizer.....	\$12.95
The Organizer.....	\$14.95
The Budgeter.....	\$13.95
Stock Option.....	\$14.95

## NEC COMPUTERS

8001A.....	\$729.00
8031.....	\$729.00
8012.....	\$549.00

## PRINTERS

8023.....	\$499.00
7710/7730.....	\$2399.00
3510/3530.....	\$1599.00

## MONITORS

JB-1260.....	\$129.00
JB-1201.....	\$159.00
JC-1201.....	\$319.00
JC-1203.....	\$729.00

# 800-233-8950

east

IN PA. CALL (717) 327-8575

477 E. THIRD ST., WILLIAMSPORT, PA. 17701

east

In-stock items shipped same day you call. No risk, no deposit on C.O.D. orders. Pre-paid orders receive free shipping within the continental United States with no waiting period for certified checks or money orders. Add 3% (minimum \$3.00) shipping and handling on all C.O.D. and Credit Card orders. NV and PA residents add sales tax. All items subject to availability and price change. **NOTE:** We stock manufacturer's and third-party software for most all computers on the market! Call today for our new catalogue.

computer mail order east

# Adventure of the Month



## The Adventure is Waiting for You.....

### ADVENTURE OF THE MONTH

■ **Six month subscription:**

- Cassette — \$29
- Disk — \$49

■ **Individual adventures (please specify)**

- Cassette — \$7 each
- Disk — \$10 each

■ **Three adventures on one super disk (\$26 each):**

- Arabian, Alien, and Treasure Island
- Jack the Ripper, Crime, and Around the World
- Black Hole, Windsloe Mansion, and Klondike
- James Brand

**Please specify which computer:**

- Apple™ (req. 24K for tape, 32K for disk)
- ATARI® (req. 32K for tape, 40K for disk)
- TRS-80® (req. 16K for tape, 32K for disk)

Name \_\_\_\_\_

Address \_\_\_\_\_

City/State \_\_\_\_\_ Zip \_\_\_\_\_

MasterCard  VISA  Payment enclosed

Name of Cardholder \_\_\_\_\_

MC# and Interbank#/VISA# \_\_\_\_\_

Exp. Date \_\_\_\_\_ Signature \_\_\_\_\_

Prices subject to change without notice, Apple™, ATARI® and TRS-80® are registered trademarks of The Apple Computer Company, Warner Communications and The Tandy Corporation respectively.

How would you like to go back in time to 19th century London to match wits with Jack the Ripper? Out into space to brave the swirling vortex of a black hole? Into the depths of the ocean, or on a quest to rescue a beautiful princess from the clutches of evil monsters?

You never know where **SoftSide Magazine's Adventure of the Month** might take you. But you can be sure that each month you will experience new delights and new challenges as you receive an original adventure on tape or disk, ready to load into your computer.

The cost? A six-month membership is only \$29 for the adventures on tape (\$4.83 each) or \$49 on disk (\$8.16 each). If you're not sure you can handle six full months of excitement, you can order a single adventure on tape for \$7 or on disk for \$10. You can choose from:

- |                           |                            |
|---------------------------|----------------------------|
| Arabian Adventure         | Black Hole Adventure       |
| Alien Adventure           | Windsloe Mansion Adventure |
| Treasure Island Adventure | Klondike Adventure         |
| Jack the Ripper Adventure | James Brand Adventure      |
| Crime Adventure           | Witches' Brew Adventure    |
| James Brand Adventure     | Arrow One Adventure        |
| Robin Hood Adventure      |                            |

**The Mouse that Ate Chicago Adventure**  
**Around the World in 80 Day Adventure**

To order, use coupon provided or write to:

**Adventure of the Month**  
**6 South Street**  
**Milford, NH 03055**



# Microcomputer Design of Transistor Amplifiers

by Andy Cornwall

The class A transistor amplifier is the most common circuit in analog electronics. This article presents a BASIC program that takes the mystery and tedium out of designing practical small signal amplifier stages.

**Amplifier Designer** requires:

BASIC  
(written for PET, but easily convertible)

Computer hobbyists often have a wide interest in electronics. It is not unusual for a home microcomputer to be used for electronic circuit design. The program described here is for the design of a transistor, class A, small signal amplifier stage. Essentially, you tell the program what you want the amplifier to do, and component values and amplifier operating parameters (i.e., voltages, currents, and impedances) are calculated in return. At the least, the program removes the need for tedious calculations, and you need only a minimal knowledge of transistor amplifier theory. However, the program also provides simulation capability to determine quickly how changes in amplifier specifications alter component values and parameters.

## Class A

The small signal, class A amplifier is the most common building block in analog electronics. It is basically a voltage amplifying device with a low voltage signal going in and a corresponding higher voltage signal coming out. If the gain from one amplifying stage is not enough, two or more can be chained together (or cascaded). The term "small signal" in this context means that the maximum output of the

amplifier stage is usually less than ½ watt. High-power class A amplifier stages can be designed using this program, but more efficient, though more complex, circuits are available for high-power situations.

## Generalized Model

Figure 1 is a schematic diagram of the amplifier. The circuit is intended to amplify AC inputs, such as audio,

radio, or television signals. In addition to an NPN transistor, there are eight components: collector resistor ( $R_c$ ), emitter resistor ( $R_e$ ), voltage adjusting resistor ( $R_v$ ), two base bias resistors ( $R_b$  and  $R_x$ ), and three capacitors (input, output, and bypass). The values of these eight components are calculated by the program. Also included in the schematic is load impedance ( $R_l$ ), the input impedance of the circuit or

## Listing 1

```
80 REM VERSION EXP AMP18
90 REM** A PROGRAM FOR CLASS 'A'
100 REM** AMPLIFIER DESIGN.
110 REM*****
120 REM** BY ANDREW CORNWALL **
130 REM** 66 LANDRACE CRES. **
140 REM** DARTMOUTH, NOVA SCOTIA **
150 REM** CANADA **
160 REM*****
170 K$="WITH LOAD"
180 FL$="*GAIN REDUCED BY "
190 SL$=" FOR HIGHER GAIN "
200 C$(1)="LOW TRANS. 'B'."
210 D$(1)="RAISE TRANS. 'B'."
220 C$(2)="TRANS. INTERN. RESIS."
230 D$(2)="LOWER OUT. IMPEDENCE"
240 C$(3)="LOW SUPPLY VOLTS."
250 D$(3)="RAISE SUP. VOLT."
260 NL$="*NON-OPERATING CONDITION. TO CORRECT"
270 N$(1)=" LOWER INPUT VOLTAGE/RAISE SUP. VOLT."
280 N$(2)=" LOWER VOLT. OUT/RAISE SUP. VOLT."
290 MV=.5:REM APPROX MIN VCE
300 J=10 :REM BIAS RES. CURRENT FACTOR
310 VP=.030 :REM EMIT. VOLT. FACTOR
320 PRINT"***** CLASS A AMPLIFIER DESIGN ***"
330 PRINT"ENTER AMPLIFIER SPECIFICATIONS:"
340 INPUT"SUPPLY VOLTAGE";VCC
350 INPUT"TRANSISTOR 'B'";B
360 INPUT"OUTPUT IMPEDENCE (<1000 OHMS)";RC:RC=RC*1000
370 PRINT"LOAD IMPEDENCE (<1000 OHMS) - ENTER"
380 INPUT"ZERO IF UNKNOWN";RL:RL=RL*1000
390 IF RL=0 THEN RL=1018;K$="WITHOUT LOAD"
400 RK= RC*RL/(RC+RL) :REM CALC. OUT. IMP. WITH LOAD.
410 INPUT"LOWEST SIGNAL FREQ (HERTZ)";F
420 INPUT"MAX. INPUT VOLTAGE SWING";VI
430 INPUT"MAX. OR SELECT GAIN (M/S)";G#
440 IF G#="M" THEN VO=B*VI: GOTO 480
450 IF G#<>"S" THEN 430
460 PRINT"MAX. OUTPUT VOLTAGE SWING (< WITH"
470 INPUT"LOAD IF GIVEN ABOVE)";VO
480 G=VO/VI :REM DESIRED GAIN
490 REM CHECK GAIN FOR 'B', REDUCE GAIN AND VO IF 'B' TOO LOW.
500 IF G>B THEN G=B:VO=B*VI:FLAG=1
510 REM PRELIMINARY SUPPLY VOLTAGE CONDITION CHECK.
520 IF VO>VCC-VI-MV THEN VO=VCC-VI-MV:G=VO/VI:FLAG=3
530 GD=G :REM LIMIT SET ON GAIN BY AMP. SPECS OR TRANSISTOR 'B'.
```

(continued)

device the amplifier stage will be feeding. Load impedance is a specification requested by the program.

### Choice of Transistor

The transistor you choose must be NPN silicon (the most common type) and suitable for amplifying. The only transistor specification used in the program is static (or DC) current gain, referred to as either  $\beta$  (called beta) or hfe. However, if your amplifier will be handling high-frequency signals (over 1 MHz) connected to high supply voltage (over 25 V, or so), or dissipating high power (over about 100 mW, as calculated by the program), you should be sure the transistor you intend to use can handle these extremes. In general, the "five for a dollar," NPN, small signal, amplifying transistors should be suitable for most applications.

### Using the Program

To use the program you will have to input the amplifier specifications described below.

#### Supply Voltage ( $V_{cc}$ )

Choice of supply voltage depends on the battery or other power source you want to use. Minimum practical supply voltage is about three volts.

#### Transistor $\beta$

Beta determines the maximum potential gain of the amplifier stage and influences the biasing characteristics. Unfortunately, transistor beta can be an enigma; even transistors with the same component number have different betas. Some transistor specifications mention minimum beta, others refer to 'typical' beta, and grab-bag transistors frequently come with no indication. When in doubt, you are probably safe to assume a value of 50 to 100.

#### Output Impedance

When you specify output impedance you are actually determining the value of  $R_c$ . Usually, output impedance is set equal to or less than load impedance. If in doubt, you might try setting the output impedance at 100 to 500 times the supply voltage.

#### Load Impedance

All else being equal, the effect of load impedance is to reduce voltage gain. If load impedance is entered into the program, the program compensates

### Listing 1 (continued)

```

540 AL=B/(B+1):REM BETA FACTOR USED FOR CALC. RE.
550 REM TABLE HEADING FOR RUN MONITOR;TABLE VALUES PRINTED
    DURING CALCULATION.
560 PRINT"VO      MV      VE      VV"
570 DEF FNM(X)=INT(X*100)/100
580 IE=0:RE=0
590 REM CHECK FOR NON-OPERATIONAL OUTPUT VOLTAGE CONDITION
600 IF VO<VI THEN NFLAG=1:GOTO1070
610 REM PRINT MONITOR VALUES.
620 PRINT FNM(VO),FNM(MV),FNM(VE),FNM(VV)
630 REM CALCULATE CURRENTS.
640 IQ=.5*(VO+2*MV)/RK
650 IB=IQ/B
660 IE=IQ+IB
670 REM CALC. TRANS. INTERNAL RESISTANCE RP AND RESISTOR RE.
680 RP=VP/IE
690 RE=AL*RK/G - RP
700 REM CHECK FOR TRANS. INTERNAL RESIS. COND.
710 REM IF RE IS NEG., LOWER GAIN AND VO; REFIGURE.
720 IF RE<-.1 THEN G=AL*RK/RP:FLAG=2:VO=G*VI:GOTO 580
730 IF RE<0 THEN RE=0
740 REM CALC. VOLTAGES VTEQ, VK, AND VE.
750 VTEQ=IQ*RK+IE*RE
760 VK=VCC-IQ*RC
770 VE=VK-VTEQ-VP
780 REM CHECK TO SEE THAT VE ALLOWS INPUT VOLTAGE SWING.
790 REM IF NOT LOWER GAIN AND VO (INCREASING VE); REFIGURE.
800 IF VE>=VI/2 THEN RE=0
810 IF VE<VI/2 THEN VO=VO*.95:G=VO/VI:FLAG=3:GOTO 580
820 REM CALC. VOLTAGE VV.
830 VV=VE-IE*RE
840 REM CHECK FOR SUFFICIENT SUPPLY VOLTAGE.
850 REM IF VV IS NEG., LOWER GAIN AND VO (INCREASING VV); REFIGURE.
860 IF VV<-.0001 THEN VO=VO+VV:G=VO/VI:FLAG=3:GOTO580
870 IF VV<0 THEN VV=0
880 REM IF GAIN REDUCED BY INTERNAL RESISTANCE, ATTEMPT TO RAISE
    GAIN BY
890 REM INCREASING MV (INCREASING IQ); REFIGURE.
900 IF FLAG=2 AND G>GT THEN MV=MV+VV/4:GT=G:G=GD:VO=G*VI:FLAG=0
    :GOTO580
910 REM CALC. RESISTOR RV.
920 RV=VV/IE
930 REM CALCULATE BIAS VOLTAGE RESISTORS.
940 VB=VE+.7
950 RB=(VCC-VB)/((J+1)*IB)
960 RX=VB/(J*IB)
970 REM CALCULATE INPUT IMPEDENCE
980 ZIN=1/(1/RX+1/RB+AL/(B*(RE+RP)))
990 REM CALCULATE CAPACITOR VALUES
1000 DEF FNM(X)=1/(2*pi*f*X)
1010 CI=FNM(ZIN)
1020 IF RV<1 THEN CB=0:GOTO 1060
1030 RA=RE+RP+(RB*RX)/(B*(RB+RX))
1040 RR=RA*RV/(RA+RV)
1050 CB=FNM(RR)
1060 IF K$="WITH LOAD" THEN CL=FNM(RL)
1070 REM DISPLAY COMPONENT VALUES
1080 DEF FNO(X)=INT(X*100)/100000
1090 DEF FNR(X)=INT(X/10)/100
1100 DEF FNC(X)=INT(10*B*X)/100
1110 DEF FNI(X)=INT(X*10+6)/1000
1120 DEF FNW(X)=INT(1000*X)/1000
1130 PRINT"Component Values:"
1140 PRINT"RESISTORS (<000 OHMS):"
1150 PRINT"RC      RE      RV      RB      RX"
1160 PRINT FNR(RC);TAB(6)FNO(RE);TAB(14)FNO(RV);TAB(24)FNR(RB);
1170 PRINT TAB(32)FNR(RX);" "
1180 PRINT"CAPACITORS (MICROFARADS):"
1190 PRINT"      INPUT      OUTPUT      BYPASS"
1200 PRINT TAB(2)FNC(CI);TAB(12)FNC(CL);TAB(23)FNC(CB)
1210 REM FLAG NON-OPERATIONAL CONDITION
1220 IF RV<0 THEN NFLAG=2
1230 IF NFLAG>0 THEN PRINT"NL#:"PRINT N*(NFLAG)
1240 PRINT TAB(7)"PRESS SPACE TO CONTINUE"
1250 GETA$:IFA$<> " THEN 1250
1260 REM DISPLAY PARAMETERS

```

(Continued)

## Listing 1 (continued)

```

1270 PRINT "OPERATING PARAMETERS"
1280 PRINT "IMPEDENCES (<'000 OHMS>):"
1290 PRINT "INPUT  OUTPUT  OUTPUT (WITH LOAD)"
1300 PRINT FNR(ZIN);TAB(7)FNR(RC);
1310 IF K$="WITH LOAD" THEN PRINT TAB(16)FNR(RK)
1320 PRINT
1330 PRINT "QUIESCENT CURRENT (MILLIAMPS):"
1340 PRINT "COLLECTOR  BIAS"
1350 PRINT FNI(IQ);TAB(13)FNI(IB)
1360 PRINT "QUIESCENT VOLTAGES:"
1370 PRINT "SUPPLY  COLLECTOR  EMITTER  BASE"
1380 PRINT FNV(VCC);TAB(8)FNV(VK);TAB(20)FNV(VE);TAB(30)FNV(VB);" "
1390 PRINT "SIGNAL VOLTAGES (MAX. SWING):"
1400 PRINT "INPUT  OUTPUT"
1410 PRINT VI;TAB(7)FNV(VI*G);" ";K$;" "
1420 PRINT TAB(7)"PRESS SPACE TO CONTINUE"
1430 GETA$;IF A$="" THEN 1430
1440 REM DISPLAY PARAMETERS
1450 PRINT "GAIN: ";FNV(G);" ";K$;" "
1460 PRINT "MIN. DESIGN FREQ. (HERTZ) ";F
1470 PRINT "MAX. TRANS. PWR. DIS. (MW'S)";FNI(VTEQ*IQ)
1480 IF NFLAG=0 THEN 1500
1490 IF FLAG=0 THEN PRINT:PRINT FL$;C$(FLAG);PRINT SL$;D$(FLAG)
1500 INPUT "ENTER 1 TO SEE COM. VALUES; 0 TO END"; P
1510 IF P=1 THEN 1070
1520 IF P<> 0 THEN 1500
1530 END

```

200 Hz. Non-audio signals are considerably higher; for example, the low end of the AM broadcast band is 540,000 Hz.

*Input Voltage Swing*

Input voltage swing is the peak-to-peak value of input voltage. If, for instance, an input signal varies from +0.1 V to -0.1 V, the peak-to-peak voltage swing is 0.2 V.

*Maximum or Select Gain*

Choosing maximum gain automatically sets gain at its maximum value, given supply voltage, output impedance, and transistor characteristics (mainly beta, but also  $V_p$  described below).

*Output Voltage Swing*

If you choose "select gain" you will have to specify the peak-to-peak output. You'll get increased input impedance by reducing gain below maximum, but you may want to set output voltage somewhat higher than required to provide some design head room. In any case, output voltage swing must be somewhat less than the supply voltage. Also, output voltage swing cannot

for potential loss of gain when calculating resistor values. Enter zero if you do not know load impedance; the default load resistance is 10K megohms, which is virtually no load at all.

*Lowest Signal Frequency*

This frequency helps determine capacitor values. The lowest hi-fidelity audio frequency is about 20 Hz, and lowest AM radio audio is about 100 to

## PERRY PERIPHERALS REPAIRS KIMs!!

### (SYM and AIMs Too)

- We will Diagnose, Repair, and Completely Test your Single Board Computer
- We Socket all replaced Integrated Circuits
- You receive a 30-day Parts and Labor Warranty
- Your repaired S.B.C. returned via U.P.S. — C.O.D., Cash

Don't delay! Send us your S.B.C. for repair today  
Ship To: (Preferably via U.P.S.)

**PERRY PERIPHERALS**  
6 Brookhaven Drive  
Rocky Point, NY 11778

### KIM-1 REPLACEMENT MODULES

- Exact replacement for MOS/Commodore KIM-1 S.B.C.
- Original KIM-1 firmware — 1K and 4K RAM versions

### REPLACEMENT KIM-1 KEYBOARDS

- Identical to those on early KIMs — SST switch in top right corner
- Easily installed in later model KIMs

*Perry Peripherals is an authorized HDE factory service center.*

*Perry Peripherals carries a full line of the acclaimed HDE expansion components for you KIM, SYM, and AIM, including RAM boards, Disk Systems, and Software like HDE Disk BASIC V1.1. Yes, we also have diskettes. For more information write to: P.O. Box 924, Miller Place, NY 11764, or Phone (516) 744-6462.*

imply a gain higher than transistor beta. (The gain of the amplifier is defined as output voltage divided by input voltage.)

### The Program Takes Over

Despite your efforts to enter logical amplifier criteria, there may be inconsistencies that will lower your output voltage swing (or gain) specification. You can observe the iterative calculation process with the "run monitor" feature. If output voltage has been reduced, there will be a suggestion on how to recover gain at the end of the program output. When you indicate maximum gain, there will be a similar message on how to increase gain. There are inconsistencies that the program does not fix, however. These will make  $R_v$  negative, or drop gain below one. When either of these conditions occurs, you will receive a "non-operating condition" message along with a suggestion on how to overcome the problem.

### Final Pointers

Now that you are ready to start designing amplifiers, here are a few tips.

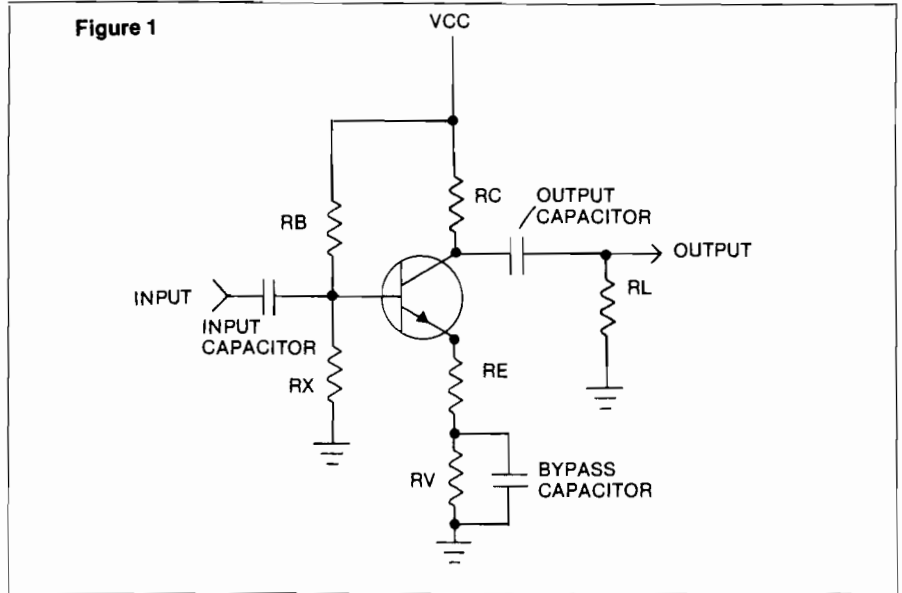

- Try to have quiescent collector current of at least 1 mA. With some transistors, considerably higher collector current is desirable. To increase collector current, lower output impedance.
- If the design value of  $R_v$  happens to be near zero, this resistor and the bypass

- capacitor are not needed. Similarly,  $R_e$  is not needed if its value is near zero.
- When cascading amplifier stages, the output capacitor of one is the input capacitor of the other. Only one capacitor is needed to link the stages.
- You will find that standard values of commercially available resistors and

## QCB-9 SINGLE BOARD COMPUTER

- 6809 BASED
- RUNS TSC FLEX DOS
- ★ QCB-9/1 S-100 BUS
- ★ QCB-9/2 SS-50 BUS

**\$149.00\***

\*PARTIAL KIT

### FEATURES

- 5 1/4" Floppy Controller
- Serial RS-232 Port
- Centronics Type Printer Port
- Keyboard/Parallel Port
- 24K Bytes of Memory
- QBUG Resident Monitor
- 6802 Adaptor

**FULLY ASSEMBLED & TESTED \$389.00**

- 48-hour Burn-in
- 90 Day Warranty

**NAKED-09 SS-50 6809 CPU CARD \$49.95\***

- ★ 1K OF RAM AT E400 Assembled & Tested \$149.00 PCB & Documentation Only
- ★ 6K OF EPROM AT E800-FFFF 2 MHz Version \$189.00
- ★ HIGH QUALITY DOUBLE SIDED PCB ★ SOLDER MASKED ★ SILK SCREENED

**TSC, FLEX DOS, ASSEMBLER, EDITOR \$150.00**

**QBUG RESIDENT MONITOR \$50.00**

- ★ Disc Boot
- ★ Memory Exam & Exchange
- ★ Memory Dump
- ★ Memory Test
- ★ Zero Memory
- ★ Fill Memory
- ★ Break Points
- ★ Jump to User Program
- ★ Register Display & Change

QBUG IS A TRADEMARK OF LOGICAL DEVICES INC., Copyright 1981

PHONE ORDERS: (305) 776-5870

## LOGICAL DEVICES INC.

COMPUTER PRODUCTS DIVISION

781 W. OAKLAND PARK BLVD. • FT. LAUDERDALE, FL 33311  
TWX: 510-955-9496 • WE ACCEPT VISA, MC, CHECKS, C.O.D., MONEY ORDER

## APEX SOFTWARE CO.

"INTERESTING SOFTWARE"

8781 Troy St. • Spring Valley, CA 92077

(619) 466-2200

### WORLD ALPHABETS

World Alphabets software interface showing various fonts.

समसत खननल लइथ लउक

Дети едят бесимая пшеница.

Ten type fonts allow user to create text or use pronunciation tables in Arabic, Cherokee Indian, Hieroglyphics, Greek, Hebrew, Japanese, Russian, Sanskrit or Roman. Author: W.C. Jones

**Diskette \$89.95**

### BASIC LEARNING PACKAGE

An introduction to the Apple II or II Plus Computer. Teaches beginner to program in BASIC. Author: J.J. Sudikatus

**Diskette \$49.95**

Both require an Apple II with Applesoft, 48K, plus disk drive. Epsom printer with Graftrax is optional.

Apple II or II Plus and Applesoft are trademarks of Apple Computer, Inc.

## Sample Run

```

*** CLASS A AMPLIFIER DESIGN ***
ENTER AMPLIFIER SPECIFICATIONS:

SUPPLY VOLTAGE? 14
TRANSISTOR 'B'? 250
OUTPUT IMPEDENCE ('000 OHMS)? 2
LOAD IMPEDENCE ('000 OHMS) - ENTER
ZERO IF UNKNOWN? 30
LOWEST SIGNAL FREQ (HERTZ)? 20
MAX. INPUT VOLTAGE SWING? .5
MAX. OR SELECT GAIN (M/S)? S
MAX. OUTPUT VOLTAGE SWING ( WITH
LOAD IF GIVEN ABOVE)? '10

COMPONENT VALUES

RESISTORS ('000 OHMS):
RC      RE      RV      RB      RX
 2      .08318  .71758  84.77  26.06

CAPACITORS (MICROFARADS):
INPUT  OUTPUT  BYPASS
.73    .26     57.05

PRESS SPACE TO CONTINUE

OPERATING PARAMETERS

IMPEDENCES ('000 OHMS):
INPUT  OUTPUT  OUTPUT (WITH LOAD)
10.77  2        1.87

QUIESCENT CURRENT (MILLIAMPS):
COLLECTOR  BIAS
2.933      .011

QUIESCENT VOLTAGES:
SUPPLY  COLLECTOR  EMITTER  BASE
14      8.133      2.358    3.058

SIGNAL VOLTAGES (MAX. SWING):
INPUT  OUTPUT
.5     10 WITH LOAD

PRESS SPACE TO CONTINUE

GAIN: 20 WITH LOAD
MIN. DESIGN FREQ. (HERTZ) 20
MAX. TRANS. PWR. DIS. (MW'S) 16.852
ENTER 1 TO SEE COM. VALUES; 0 TO END? \

```

capacitors seldom match component design values. For resistors, use the closest available commercial value. In theory, the capacitors used should be equal to or larger than design values, but somewhat lower value capacitors should be acceptable for most purposes.

- It is likely that an actual amplifier stage will not have measured voltages, currents, and gain exactly as calculated by the program. Such deviation is to be expected considering components used will not exactly match design values. Also, actual transistor beta probably differs from that used in the program. However, unless there are large differences (greater than 20%, or so) between measured and design parameters, the amplifier should do the job you want.

## Example

An example amplifier stage design is shown in the sample run. The objective of the design is to interface an AM/FM tuner module with a power amplifier. For full output the power amplifier requires a signal of 10 V peak-to-peak, but the tuner only provides output of ½ V. Input impedance of the power amplifier [which is the load impedance for the amplifier stage] is about 30,000 ohms. The power amplifier's own power supply can be tapped to obtain a  $V_{cc}$  of 14 V.

## Try Experimenting

At the start of the program, variables MV, J, and VP are defined. The values in the program listing should be reliable in most situations, but you might want to experiment by changing the program values of these variables. The purpose of each value is mentioned in a REM statement. The value of MV should be no lower than the minimum (or saturation) collector-to-emitter voltage of your transistor. One-half volt will be sufficient for most transistors. J controls the sum of resistors  $R_b$  and  $R_x$ . A lower value of J increases  $R_b$  and  $R_x$ . This raises input impedance but makes proper transistor biasing more sensitive to the value of beta. If you are fairly certain about the beta of your transistor, you can lower J. Conversely, increasing J makes knowing beta less important. If you plan to run your transistor near its maximum output rating, beta will drop as the transistor gets hotter. In situations of variable or uncertain beta, use a higher value for J to increase bias stability.

Variable VP relates to emitter diode voltage drop of a transistor. Small signal transistors have an emitter voltage drop of .025 V, while power transistors may have a drop in the range of 0.5 V.

## References

The following books are helpful if you want to learn about transistor amplifier theory.

1. Malvino, Albert Paul, *Electronics Principles*, McGraw-Hill, 1973.
2. Oleksey, Jerome E., *Practical Solid-State Circuit Design*, Howard W. Sams & Co., Inc., 1976.
3. Turino, Jon L, *Solid-State Circuits for Hobbyists and Experimenters*, Howard W. Sams & Co., Inc. 1975.

Andy Cornwall is an electronics hobbyist. After acquiring a Commodore PET he delved into computer design of electronic circuitry. You may contact him at 66 Landrace Cres., Dartmouth, Nova Scotia B2W 2P9.

MICRO

## C64 FORTH for the Commodore 64

Fig.-Forth implementation including:

- Full feature screen editor and assembler
- Forth 79 Standard Commands with extensions
- High resolution 320x200 pixel, 16 color graphics
- Sprite graphics for control of 32 sprites
- Three voice tone and music synthesizer
- Detailed manual with examples and BASIC-FORTH conversions
- Trace feature for Debugging

**\$99.95 — Disk Version**  
(Specify CBM 1540 or CBM 1541 Disk)

**\$99.95 — Cassette Version**

(CBM & Commodore 64 are Trademarks of Commodore)

**PERFORMANCE MICRO PRODUCTS**  
770 Dedham Street  
Canton, MA 02021  
(617) 828-1209



By Tim Osborn

Last month's Apple Slices presented a fast method to find an element in an ascending ordered array using a binary search technique. This month's program, ALTERNATE INDEX, expands the capabilities of BINARY-SEARCH by creating ascending ordered arrays containing any substring of the base data array. This process allows you to declare any substring of the base array as a key, sort an array of these keys in ascending order, and search with BINARY-SEARCH on that key. You can then look back in the base array to find the full string value.

One possible application of this system would be to let a user quickly find information on a part, either by part number or part name. The base array would contain a list of parts and related information, including part number and part name. The array would be processed by ALTERNATE-INDEX twice — once for the part number key and once for the part name key. Once the key arrays are generated, the user would supply a part name or number. The system would look in the proper key array for a match, using BINARY-SEARCH. Once the item is found in the key array, the system can locate the element in the base array to display all the related data.

### How ALTERNATE-INDEX Works

Because of the way Applesoft string arrays are stored in memory, it is possible to have two or more arrays that contain the same data without duplicating this data. Applesoft string arrays are actually a table of pointers to the related data, which is stored elsewhere in memory. Therefore, it is possible to build arrays with pointers to the same data contained in another array. With every pointer there is also a length field, which is the length of the string for that array element. By manipulating the length field and pointer, ALTERNATE-INDEX builds pointers to substrings of the base array, then sorts

this key array in ascending order. The syntax is:

```
& S{XX$,YY$,B,E,ZZ%}
```

where

1. XX\$ is the base array (any legal string array name).
2. YY\$ is the key array (any legal string array name).
3. B is an Applesoft arithmetic expression that represents the beginning position of the key in the base array. This is relative to the beginning of the base string so that 0 is the first byte and (LEN{XX\$(n) - 1) is the last byte of the base array element n. If B is greater than (LEN{XX\$(n) - 1), then a null key element will result.
4. E is the ending position of the key. It can be replaced with any legal Applesoft arithmetic expression. If B is greater than E then a syntax error will result. If E is greater than (LEN{XX\$(n) - 1) for any element n in the base array, then the value of (LEN{XX\$(n) - 1) will be substituted for E.
5. The value contained in ZZ%(n) will be the element number in XX\$ where the key in YY\$(n) can be found as a substring. Any legal integer array name can be substituted for ZZ%.
6. The number of elements contained in each array must be the same or a syntax error will result.
7. All arrays must be one-dimensional or a syntax error will result.

ALTERNATE-INDEX is programmed so that you can use the & GET command of BINARY-SEARCH directly. If BINARY-SEARCH is not in memory upon encountering the & GET command, a syntax error message will be produced. To use & GET with ALTERNATE-INDEX you must BLOAD BINARY-SEARCH instead of BRUNING it.

If you will be using arrays that may contain duplicate keys, or wish to find the first key higher or lower than the search key, you can write your own serial search routine instead of using BINARY-SEARCH. The advantage of

using ALTERNATE-INDEX in these cases is that you only go through the overhead of pulling out the key substring once instead of each time you search for a value.

To access an element in the base array, search the key array (either with BINARY-SEARCH or your own routine) for a desired value. Once the key element is found you then take the value found in the integer array element (ZZ%) that has the same element number as this key element. This is the number of the element in the base array that contains the desired data. For example, say we used the following statement to build the alternate index:

```
& S{QQ$,RR$,2,5,RR%}
```

and there is an element QQ\$(n) that contains the following string:

```
"504134WIREHOUSINGS"
```

There would be an element RR\$(i) that points at the substring "4134" and an element RR%(i) that contains the integer value n. We then use this integer to access the proper element in the base array.

Once the alternate index is built, elements in the base array can be found very quickly when BINARY-SEARCH is used to locate the keys in the key array. An even bigger plus to this system is that it allows you to access quickly the same data with more than one key substring without duplicating the data.

### Subroutine Hints

ALTERNATE-INDEX can be used to sort the base array by specifying the base array as the key array and specifying a B value of 0 and an E value of 255. ALTERNATE-INDEX is set up to load at \$90AF, so HIMEM should be set at 37038 or lower. ALTERNATE-INDEX is designed to run on a 48K Apple II with MAXFILES set at three or less.

Because of space limitations I did not go into detail on how the subroutine works. If you have any questions please contact me at 62 Clement St., Manchester, NH 03102.

Alternate Index (continued)

```

1 *****
2 * APPLE SLICES BY TIM OSBORN *
3 * A L T E R N A T E   I N D E X *
4 *****
5 ;
6 ; < EQUATES >
7 ARRY1PTR EPZ $5/ ;WORK POINTER FOR SRC. ARRAY
8 PAIR1AD EPZ ARRY1PTR ;REUSE ARRY1PTR
9 ARRY2PTR EPZ $52 ;WORK POINTER FOR DEST. ARRAY
10 ARRY3PTR EPZ $54 ;WORK POINTER FOR INT. ARRAY
11 LOWTR EPZ $9B ;APPLESOFT WORK PTR
12 PAIR2AD EPZ LOWTR ;REUSE LOWTR FOR INTERNAL PURP
13 CHRGET EPZ $B1 ;A-SOFT'S ROUTINE TO GET A BYTE
14 ;
15 AMPERV EQU $3F5 ;AMPERSAND VECTOR LOCATED HERE
16 CHKOPN EQU $DEBB ;CHECK FOR OPEN QUOTE
17 GETARYPT EQU $F7D9 ;ROUTINE TO FIND ARRAY DESC
18 CHKCOM EQU $DEBE ;CHECK FOR COMMA
19 SYNERR EQU $DEC9 ;DISPLAY SYNTAX ERROR
20 DATA EQU $D995 ;ADV TXTPTR TO END OF STMT
21 FRMNUM EQU $DD67 ;EVAL ARITH EXP.,PUTS IN FAC
22 CONINT EQU $E6FB ;CONVTS FAC TO INT,PUTS IN X
23 GET EQU $9410 ;ENTRY TO BIN SEARCH ROUTINE
24 ;
25 ORG $90AF
26 OBJ $800 ;FOR LISA
27 SETVEC LDA #$4C ;JUMP ABSOLUTE
28 STA AMPERV
29 LDA #ENTRY ;LSB OF ENTRY ADDRESS
30 STA AMPERV+1
31 LDA /ENTRY ;MSB OF ENTRY ADDRESS
32 STA AMPERV+2
33 RTS
34 ENTRY CMP #$53 ;CHECK FOR SORT 'S'
35 BEQ SRNTENTRY
36 CMP #$BE ;CHECK FOR GET COMMAND
37 BNE ENTRYERR
38 LDA #$20 ;IF GET, MAKE SURE
39 LDX #00
40 CMP GET,X ;BINARY SEARCH IS IN MEMORY
41 BEQ ENTRY1
42 ENTRYERR JMP SYNERR ;SYNTAX ERROR
43 ENTRY1 LDA #$B1 ;CHRGET ROUTINE
44 INX
45 CMP GET,X
46 BNE ENTRYERR
47 JMP GET
48 SRNTENTRY LDA ARRY1PTR ;SAVE ZEROPAGE LOCATIONS
49 STA ZEROSV
50 LDA ARRY1PTR+1
51 STA ZEROSV+1
52 LDA ARRY2PTR
53 STA ZEROSV+2
54 LDA ARRY2PTR+1
55 STA ZEROSV+3
56 LDA ARRY3PTR
57 STA ZEROSV+4
58 LDA ARRY3PTR+1
59 STA ZEROSV+5
60 JSR CHRGET ;GET NEXT CHARACTER
61 JSR CHKOPN ;SHOULD BE ' ('
62 JSR GETARYPT ;GET SOURCE ARRAY DESC.
63 JSR CHKONE ;SHOULD BE A 1-DIM ARRAY
64 LDA LOWTR ;SAVE ARRAY DESC. ADDRESS
65 STA SAVARRY1
66 LDA LOWTR+1
67 STA SAVARRY1+1
68 JSR CHKCOM ;CHK FOR COMMA+LOAD NXT BYTE
69 JSR GETARYPT ;GET DEST. ARRAY DESC
70 JSR CHKONE ;SHOULD BE A 1-DIM ARRAY
71 LDA LOWTR ;SAVE ARRAY DESC. ADDRESS
72 STA SAVARRY2
73 LDA LOWTR+1
74 STA SAVARRY2+1
75 JSR CHKCOM
76 JSR FRMNUM ;EVAL STARTING POS EXPRESS
77 JSR CONINT ;CONVERT TO INTEGER,PUT IN X
78 STX STARTPOS ;AND SAVE
79 JSR CHKCOM
80 JSR FRMNUM ;EVAL END POSITION EXPRESS
81 JSR CONINT ;CONVERT TO INTEGER
82 STX ENDPOS ;AND SAVE
83 CPX STARTPOS ;MAKE SURE ENDPOS >= START POS
84 BCC ENTRYERR ;NO GOOD

```

```

9142 20 BE DE 85 JSR CHKCOM
9145 20 D9 F7 86 JSR GETARYPT ;GET INTEGER ARRAY POINTER
9148 20 6A 93 87 JSR CHKONE ;MAKE SURE 1-DIM. ARRAY
914B A5 9B 88 LDA LOWTR ;SAVE DESC. ADRS.
914D 8D 58 93 89 STA SAVARRY3
9150 A5 9C 90 LDA LOWTR+1
9152 8D 59 93 91 STA SAVARRY3+1
9155 20 76 93 92 JSR SETPTR1 ;ESTABLISH ARRY1 POINTER
9158 20 81 93 93 JSR SETPTR2 ;ESTABLISH ARRY2 POINTER
915B 20 8C 93 94 JSR SETPTR3 ;ESTABLISH ARRY3 POINTER
915E A0 05 95 LDY #5
9160 B1 50 96 LDA (ARRY1PTR),Y ;GET SIZE OF ARRAY
9162 8D 63 93 97 STA SIZE+1 ;MAKE LOW/HIGH
9165 D1 52 98 CMP (ARRY2PTR),Y ;MUST BE EQUAL SIZE ARRAYS
9167 F0 03 99 BEQ SIZEEQ1 ;SIZES ARE EQUAL
9169 4C D0 90 100 JMP ENTRYERR ;SIZES NOT EQUAL
916C D1 54 101 SIZEEQ1 CMP (ARRY3PTR),Y
916E F0 03 102 BEQ SIZEEQ2
9170 4C D0 90 103 JMP ENTRYERR ;SIZES NOT EQUAL
9173 C8 104 SIZEEQ2 INY
9174 B1 50 105 LDA (ARRY1PTR),Y
9176 8D 62 93 106 STA SIZE
9179 D1 52 107 CMP (ARRY2PTR),Y
917B F0 03 108 BEQ SIZEEQ3 ;SIZES ARE EQUAL
917D 4C D0 90 109 JMP ENTRYERR ;SIZES NOT EQUAL
9180 D1 54 110 SIZEEQ3 CMP (ARRY3PTR),Y
9182 F0 03 111 BEQ SIZEEQ4
9184 4C D0 90 112 JMP ENTRYERR ;SIZES NOT EQUAL
9187 A9 07 113 SIZEEQ4 LDA #07
9189 20 97 93 114 JSR ARY1PLUS ;ARRY1PTR=ARRY1PTR+7
918C A9 07 115 LDA #07
918E 20 A3 93 116 JSR ARY2PLUS ;ARRY2PTR=ARRY2PTR+7
9191 A9 07 117 LDA #07
9193 20 AF 93 118 JSR ARY3PLUS ;ARRY3PTR=ARRY3PTR + 7
9196 20 CD 93 119 JSR INITINT ;INITILIAZE INTEGER ARRAY
9199 AD 62 93 120 TRANSFER LDA SIZE ;SEE IF MOVE-COUNT = 0
919C 00 63 93 121 ORA SIZE+1
919F D0 03 122 BNE NOTDONE ;MOVE IS NOT DONE
91A1 4D 27 92 123 JMP STRTSRT ;DONE, NOW SORT
91A4 A0 00 124 NOTDONE LDY #00
91A6 B1 50 125 LDA (ARRY1PTR),Y ;GET LENGTH OF ELEMENT
91A8 8D 5A 93 126 STA ELMNTLEN ;SAVE
91AB C9 00 127 CMP #00
91AD D0 0E 128 BNE FOUNDEL
91AF A9 00 129 NOELMNT LDA #00 ;NULL ELEMENT
91B1 8D 5F 93 130 STA NEWLEN ;ZERO OUT LEN + ADDRESS
91B4 8D 5D 93 131 STA NEWAD
91B7 8D 5E 93 132 STA NEWAD+1
91BA 4C 04 92 133 JMP ESTDESC ;GO ESTABLISH DESCRIPTOR
91BD C8 134 FOUNDEL INY
91BE B1 50 135 LDA (ARRY1PTR),Y ;GET ADDRESS OF ELEMENT
91C0 8D 60 93 136 STA ELMNTPTR ;AND SAVE
91C3 C8 137 INY
91C4 B1 50 138 LDA (ARRY1PTR),Y
91C6 8D 61 93 139 STA ELMNTPTR+1
91C9 AD 5A 93 140 LDA ELMNTLEN ;IF ELMNTLEN < STARTPOS
91CC CD 5B 93 141 CMP STARTPOS ;THEN ADDRESS + LENGTH = 0
91CF 90 DE 142 BCC NOELMNT
91D1 18 143 CLC
91D2 AD 60 93 144 LDA ELMNTPTR ;COMPUTE AD + LEN
91D5 6D 5B 93 145 ADC STARTPOS ;AND SAVE
91D8 8D 5D 93 146 STA NEWAD
91DB AD 61 93 147 LDA ELMNTPTR+1
91DE 69 00 148 ADC #00
91E0 8D 5E 93 149 STA NEWAD+1
91E3 AD 5C 93 150 LDA ENDPOS ;SEE IF ENDPOS > OR=ELMNTLEN
91E6 CD 5A 93 151 CMP ELMNTLEN
91E9 80 10 152 BCS SHORTER ;YES, SO USE ELMNTLEN
91EB 38 153 SEC
91EC AD 5C 93 154 LDA ENDPOS ;ELSE COMPUTE LEN,USE END POS
91EF ED 5B 93 155 SBC STARTPOS
91F2 8D 5F 93 156 STA NEWLEN ;(NEWLEN=ENDPOS-STARTPOS+1)
91F5 EE 5F 93 157 INC NEWLEN
91F8 4C 04 92 158 JMP ESTDESC ;GO ESTABLISH DESCRIPTOR
91FB AD 5A 93 159 SHORTER LDA ELMNTLEN ;(NEWLEN=ELMNTLEN-STARTPOS)
91FE ED 5B 93 160 SBC STARTPOS ;(CARRY IS SET)
9201 8D 5F 93 161 STA NEWLEN
9204 AD 5F 93 162 ESTDESC LDA NEWLEN ;PUT LENGTH IN NEW
9207 A0 00 163 LDY #00 ;DSCRPTR END
9209 91 52 164 STA (ARRY2PTR),Y
920B C8 165 INY

```

(continued)

Alternate Index (continued)

920C AD 5D 93 166 LDA NEWAD ;NO DO ADDRESS  
 920F 91 52 167 STA (ARRY2PTR),Y  
 9211 C8 168 INY  
 9212 AD 5E 93 169 LDA NEWAD+1  
 9215 91 52 170 STA (ARRY2PTR),Y  
 9217 A9 03 171 LDA #03  
 9219 20 97 93 172 JSR ARY1PLUS ;ARRY1PTR=ARRY1PTR+3  
 921C A9 03 173 LDA #03  
 921E 20 A3 93 174 JSR ARY2PLUS ;ARRY2PTR=ARRY2PTR+3  
 9221 20 BB 93 175 JSR DECSIZE ;DECREMENT ELEMENT COUNT  
 9224 4C 99 91 176 JMP TRANSFER  
 9227 20 81 93 177 STRTSRT JSR SETPTR2 ;RESET ARRAY2 POINTERS  
 922A 20 8C 93 178 JSR SETPTR3 ;RESET ARRAY3 POINTERS  
 922D A0 05 179 LDY #05  
 922F B1 52 180 LDA (ARRY2PTR),Y  
 9231 8D 63 93 181 STA SIZE+1 ;MAKE LOW/HIGH  
 9234 C8 182 INY  
 9235 B1 52 183 LDA (ARRY2PTR),Y  
 9237 8D 62 93 184 STA SIZE  
 923A 20 BB 93 185 DOSORT JSR DECSIZE ;DEC SIZE (PAIRS=ELMNTS-1)  
 923D D0 08 186 BNE DOSORT1 ;MORE PASSES TO MAKE  
 923F AD 62 93 187 LDA SIZE  
 9242 D0 03 188 BNE DOSORT1 ;MORE PASSES TO MAKE  
 9244 4C DF 92 189 JMP DONEPASS ;NO MORE SWAPS ARE POSSIBLE  
 9247 A9 07 190 DOSORT1 LDA #07  
 9249 20 A3 93 191 JSR ARY2PLUS ;ADD 7 TO DESC. BASE ADRS.  
 924C A9 07 192 LDA #07 ;+ 7 TO ARRY2 BASE DESC.  
 924E 20 AF 93 193 JSR ARY3PLUS  
 9251 A9 00 194 LDA #00  
 9253 8D B3 90 195 STA SWAPFLAG  
 9256 8D B1 90 196 STA COUNT ;INIT PAIR COUNT  
 9259 8D B2 90 197 STA COUNT+1  
 925C A0 00 198 SORTLP2 LDY #00 ;INIT Y  
 925E B1 52 199 LDA (ARRY2PTR),Y ;GET LENGTH OF 1ST PAIR MEMBER  
 9260 8D AF 90 200 STA PAIR1LEN  
 9263 C8 201 INY  
 9264 B1 52 202 LDA (ARRY2PTR),Y ;GET ADRS. OF 1ST PAIR MEMBER  
 9266 85 50 203 STA PAIR1AD  
 9268 C8 204 INY  
 9269 B1 52 205 LDA (ARRY2PTR),Y  
 926B 85 51 206 STA PAIR1AD+1  
 926D C8 207 INY  
 926E B1 52 208 LDA (ARRY2PTR),Y ;GET LENGTH OF 2ND PAIR MEMBER  
 9270 8D B0 90 209 STA PAIR2LEN  
 9273 C8 210 INY  
 9274 B1 52 211 LDA (ARRY2PTR),Y ;GET ADRS. OF 2ND. PAIR MEMBER  
 9276 85 9B 212 STA PAIR2AD  
 9278 C8 213 INY  
 9279 B1 52 214 LDA (ARRY2PTR),Y  
 927B 85 9C 215 STA PAIR2AD+1  
 927D EE B1 90 216 INC COUNT ;INCREMENT COMPARE COUNT  
 9280 D0 03 217 BNE PAIRNE  
 9282 EE B2 90 218 INC COUNT+1  
 9285 AD B0 90 219 PAIRNE LDA PAIR2LEN ;FIND SHORTER ELEMENT  
 9288 CD AF 90 220 CMP PAIR1LEN  
 928B B0 06 221 BCS PAIR2LNG  
 928D AE B0 90 222 LDX PAIR2LEN ;PAIR MEMBER 2 IS SHORTER  
 9290 4C 96 92 223 JMP PAIR2SHT  
 9293 AE AF 90 224 PAIR2LNG LDX PAIR1LEN ;PAIR MEMBER 2 IS LONGER OR =  
 9296 D0 0B 225 PAIR2SHT BNE COMPSTRT ;IF SHORTEST=0;MAYBE=  
 9298 AD B0 90 226 LDA PAIR2LEN ;COMPARE LENGTHS  
 929B CD AF 90 227 CMP PAIR1LEN  
 929E B0 11 228 BCS DONEYET ;PAIR2LEN = OR > PAIR1LEN  
 92A0 4C 00 93 229 JMP SWAP ;P2LN=0&P1LN#0  
 92A3 A0 00 230 COMPSTRT LDY #00 ;INIT Y  
 92A5 B1 9B 231 COMPLP LDA (PAIR2AD),Y ;COMPARE CHARACTERS  
 92A7 D1 50 232 CMP (PAIR1AD),Y  
 92A9 90 55 233 BCC SWAP ;PAIR1 > PAIR2  
 92AB D0 04 234 BNE DONEYET ;PAIR1 < PAIR2  
 92AD C8 235 INY  
 92AE CA 236 DEX  
 92AF D0 F4 237 BNE COMPLP ;MORE BYTES TO COMPARE  
 92B1 A9 03 238 DONEYET LDA #03  
 92B3 20 A3 93 239 JSR ARY2PLUS ;BUMP ARRY2PTR + 3  
 92B6 A9 02 240 LDA #02  
 92B8 20 AF 93 241 JSR ARY3PLUS ;BUMP ARRY3PTR + 2  
 92BB AD B1 90 242 LDA COUNT ;SEE IF WE HAVE  
 92BE CD 62 93 243 CMP SIZE ;COMPARED ALL ACTIVE PAIRS  
 92C1 F0 03 244 BNE DONEYET1  
 92C3 4C 5C 92 245 JMP SORTLP2 ;NO CONTINUE COMPARES  
 92C6 AD B2 90 246 DONEYET1 LDA COUNT+1 ;MAYBE  
 92C9 CD 63 93 247 CMP SIZE+1  
 92CC F0 03 248 BEQ DONEYET3 ;MORE COMPS THIS PASS?

Alternate Index (continued)

92CE 4C 5C 92 249 JMP SORTLP2 ;NO - CONTINUE PASS  
 92D1 AD B3 90 250 DONEYET3 LDA SWAPFLAG ;SEE IF WE NEED MORE PASSES  
 92D4 F0 09 251 BEQ DONEPASS ;NO SWAPS-SO WE ARE DONE  
 92D6 20 81 93 252 JSR SETPTR2 ;RESET ARRAY2 POINTERS  
 92D9 20 8C 93 253 JSR SETPTR3 ;RESET ARRAY3 POINTERS  
 92DC 4C 3A 92 254 JMP DOSORT ;CONTINUE SORT  
 92DF AD 64 93 255 DONEPASS LDA ZEROSV ;RESTORE ZERO PAGE  
 92E2 85 50 256 STA ARRY1PTR  
 92E4 AD 65 93 257 LDA ZEROSV+1  
 92E7 85 51 258 STA ARRY1PTR+1  
 92E9 AD 66 93 259 LDA ZEROSV+2  
 92EC 85 52 260 STA ARRY2PTR  
 92EE AD 67 93 261 LDA ZEROSV+3  
 92F1 85 53 262 STA ARRY2PTR+1  
 92F3 AD 68 93 263 LDA ZEROSV+4  
 92F6 85 54 264 STA ARRY3PTR  
 92F8 AD 69 93 265 LDA ZEROSV+5  
 92FB 85 55 266 STA ARRY3PTR+1  
 92FD 4C 95 D9 267 JMP DATA  
 9300 A0 00 268 SWAP LDY #00 ;SWAP VALUES  
 9302 AD B0 90 269 LDA PAIR2LEN ;FROM MEMBER 2  
 9305 91 52 270 STA (ARRY2PTR),Y ;TO MEMBER 1  
 9307 B1 54 271 LDA (ARRY3PTR),Y  
 9309 8D B4 90 272 STA INTEGER1 ;SAVE LOW ELEMENTS INDEX MSB  
 930C C8 273 INY  
 930D A5 9B 274 LDA PAIR2AD  
 930F 91 52 275 STA (ARRY2PTR),Y  
 9311 B1 54 276 LDA (ARRY3PTR),Y  
 9313 8D B5 90 277 STA INTEGER1+1 ;SAVE LOW ELEMENTS INDEX LSB  
 9316 C8 278 INY  
 9317 A5 9C 279 LDA PAIR2AD+1  
 9319 91 52 280 STA (ARRY2PTR),Y  
 931B B1 54 281 LDA (ARRY3PTR),Y  
 931D 8D B6 90 282 STA INTEGER2 ;SAVE HIGH ELEMENTS INDEX MSB  
 9320 AD B4 90 283 LDA INTEGER1  
 9323 91 54 284 STA (ARRY3PTR),Y ;SWAP INDEX  
 9325 C8 285 INY  
 9326 AD AF 90 286 LDA PAIR1LEN  
 9329 91 52 287 STA (ARRY2PTR),Y  
 932B B1 54 288 LDA (ARRY3PTR),Y  
 932D 8D B7 90 289 STA INTEGER2+1 ;SAVE HIGH ELEMENTS INDEX LSB  
 9330 AD B5 90 290 LDA INTEGER1+1  
 9333 91 54 291 STA (ARRY3PTR),Y ;SWAP  
 9335 C8 292 INY  
 9336 A5 50 293 LDA PAIR1AD  
 9338 91 52 294 STA (ARRY2PTR),Y  
 933A C8 295 INY  
 933B A5 51 296 LDA PAIR1AD+1  
 933D 91 52 297 STA (ARRY2PTR),Y  
 933F A9 01 298 LDA #01 ;SET SWAP FLAG  
 9341 8D B3 90 299 STA SWAPFLAG  
 9344 A0 00 300 LDY #00  
 9346 AD B6 90 301 LDA INTEGER2 ;COMPLETE INTEGER SWAP  
 9349 91 54 302 STA (ARRY3PTR),Y  
 934B AD B7 90 303 LDA INTEGER2+1  
 934E C8 304 INY  
 934F 91 54 305 STA (ARRY3PTR),Y  
 9351 4C B1 92 306 JMP DONEYET ;CONTINUE SORT  
 9354 307 ;INTERNAL STORAGE AREAS  
 9354 308 SAVARRY1 DFS 2,0 ;HOLD ARRAY1 DESCPTR. ADRS.  
 9356 309 SAVARRY2 DFS 2,0 ;HOLD ARRAY2 DESCPTR. ADRS.  
 9358 310 SAVARRY3 DFS 2,0 ;HOLD ARRY3 DESCPTR. ADRS.  
 935A 311 ELMNTLEN DFS 1,0 ;ELEMENT LENGTH  
 935B 312 STARTPOS DFS 1,0 ;START POSITION  
 935C 313 ENDPOS DFS 1,0 ;END POSITION  
 935D 314 NEWAD DFS 2,0 ;NEW ELEMENT ADDRESS  
 935F 315 NEWLEN DFS 1,0 ;NEW ELEMENT LENGTH  
 9360 316 ELMNTPTR DFS 2,0 ;ELEMENT POINTER  
 9362 317 SIZE DFS 2,0 ;SIZE OF ARRAY  
 9364 318 ZEROSV DFS 6,0 ;ZERO PAGE SAVE AREA  
 90AF 319 PAIR1LEN EQU SETVEC ;REUSE SETVEC(ONLY AT BRUN)  
 90B0 320 PAIR2LEN EQU SETVEC+1  
 90B1 321 COUNT EQU SETVEC+2  
 90B3 322 SWAPFLAG EQU SETVEC+4  
 90B4 323 INTEGER1 EQU SETVEC+5  
 90B6 324 INTEGER2 EQU SETVEC+7  
 936A 325 ; <<<SUBROUTINES>>>  
 936A A0 04 326 CHKONE LDY #4 ;CHECK NO. DIM TO  
 936C B1 9B 327 LDA (LOWTR),Y ;MAKE SURE IT IS A  
 936E C9 01 328 CMP #1 ;ONE DIMENSION ARRAY  
 9370 F0 03 329 BEQ CHKONEXT ;OK

(continued)

Alternate Index (continued)

9372	4C	C9	DE	330	JMP SYNNRR	;DISP SYNTAX ERROR MESSAGE
9375	60			331	CHKONEXT RTS	
9376	AD	54	93	332	SETPTR1 LDA SAVARRY1	;ESTABLISH WORK POINTER
9379	85	50		333	STA ARRY1PTR	;FOR SOURCE ARRAY DESC.
937B	AD	55	93	334	LDA SAVARRY1+1	
937E	85	51		335	STA ARRY1PTR+1	
9380	60			336	RTS	
9381	AD	56	93	337	SETPTR2 LDA SAVARRY2	;ESTABLISH ARRY2 POINTER
9384	85	52		338	STA ARRY2PTR	;FOR DESTINATION ARRAY DESC.
9386	AD	57	93	339	LDA SAVARRY2+1	
9389	85	53		340	STA ARRY2PTR+1	
938B	60			341	RTS	
938C	AD	58	93	342	SETPTR3 LDA SAVARRY3	;ESTABLISH ARRY3 POINTER
938F	85	54		343	STA ARRY3PTR	;FOR INTEGER ARRAY DESC.
9391	AD	59	93	344	LDA SAVARRY3+1	
9394	85	55		345	STA ARRY3PTR+1	
9396	60			346	RTS	
9397	18			347	ARY1PLUS CLC	;ADD ACCUM TO ARRY1PTR
9398	65	50		348	ADC ARRY1PTR	
939A	85	50		349	STA ARRY1PTR	
939C	A9	00		350	LDA #00	
939E	65	51		351	ADC ARRY1PTR+1	
93A0	85	51		352	STA ARRY1PTR+1	
93A2	60			353	RTS	
93A3	18			354	ARY2PLUS CLC	;ADD ACCUM TO ARRY2PTR
93A4	65	52		355	ADC ARRY2PTR	
93A6	85	52		356	STA ARRY2PTR	;= ADDRESS OF FIRST ELMNT
93A8	A5	53		357	LDA ARRY2PTR+1	
93AA	69	00		358	ADC #00	
93AC	85	53		359	STA ARRY2PTR+1	
93AE	60			360	RTS	
93AF	18			361	ARY3PLUS CLC	;ADD ACCUM TO ARRY3PTR
93B0	65	54		362	ADC ARRY3PTR	
93B2	85	54		363	STA ARRY3PTR	;= ADDRESS OF FIRST ELMNT
93B4	A5	55		364	LDA ARRY3PTR+1	
93B6	69	00		365	ADC #00	
93B8	85	55		366	STA ARRY3PTR+1	
93BA	60			367	RTS	
93BB	18			368	DECSIZE CLC	;DECREMENT ELEMENT COUNT
93BC	AD	62	93	369	LDA SIZE	
93BF	E9	00		370	SBC #00	
93C1	8D	62	93	371	STA SIZE	
93C4	AD	63	93	372	LDA SIZE+1	
93C7	E9	00		373	SBC #00	
93C9	8D	63	93	374	STA SIZE+1	
93CC	60			375	RTS	
93CD	A9	00		376	INITINT LDA #00	;INIT INT ARRAY
93CF	8D	B1	90	377	STA COUNT	
93D2	8D	B2	90	378	STA COUNT+1	
93D5	A0	00		379	INITLOOP LDY #00	;INIT Y REG
93D7	AD	B2	90	380	LDA COUNT+1	;STORE COUNT IN ARRAY
93DA	91	54		381	STA (ARRY3PTR),Y	
93DC	C8			382	INY	
93DD	AD	B1	90	383	LDA COUNT	
93E0	91	54		384	STA (ARRY3PTR),Y	
93E2	A9	02		385	LDA #02	;POINT TO NEXT ELEMENT
93E4	20	AF	93	386	JSR ARY3PLUS	
93E7	EE	B1	90	387	INC COUNT	
93EA	D0	03		388	BNE COUNTNE	;NO NEED TO INC COUNT+1
93EC	EE	B2	90	389	INC COUNT+1	
93EF	AD	62	93	390	COUNTNE LDA SIZE	;SEE IF WE ARE DONE INITING
93F2	CD	B1	90	391	CMP COUNT	
93F5	D0	DE		392	BNE INITLOOP	;NO
93F7	AD	63	93	393	LDA SIZE+1	;MAYBE
93FA	CD	B2	90	394	CMP COUNT+1	
93FD	D0	D6		395	BNE INITLOOP	
93FF	60			396	RTS	;ALL DONE

MICRO

# What's eating your Apple?<sup>®</sup>

Find out with Apple-Cillin II™

If you use your Apple for your business or profession, you probably rely on it to save you time and money. You can't afford to guess whether it is working properly or not. Now you don't have to guess. Now you can find out with Apple-Cillin II.

Apple-Cillin II is the comprehensive diagnostic system developed by XPS to check the performance of your Apple II computer system. Apple-Cillin II contains 21 menu driven utilities including tests for RAM memory, ROM memory, Language Cards, Memory Cards, DISK system, Drive Speed, Keyboard, Printer, CPU, Peripherals, Tape Ports, Monitors and more. These tests will thoroughly test the operation of your Apple, and either identify a specific problem area or give your system a clean bill of health. You can even log the test results to your printer for a permanent record.

Apple-Cillin II works with any 48K Apple system equipped with one or more disk drives.

To order Apple-Cillin II - and to receive information about our other products - Call XPS Toll-Free: 1-800-233-7512. In Pennsylvania: 1-717-243-5373.

Apple-Cillin II: \$49.95. PA residents add 6% State Sales Tax.



XPS, Inc.

323 York Road  
Carlisle, Pennsylvania 17013

800-233-7512  
717-243-5373

Apple II is a registered trademark of Apple Computer Inc.

# AARDVARK

TRS-80 COLOR

OSI

VIC-64

VIC-20

SINCLAIR

TIMEX



**QUEST** — A NEW IDEA IN ADVENTURE GAMES! Different from all the others. Quest is played on a computer generated map of Alesia. Your job is to gather men and supplies by combat, bargaining, exploration of ruins and temples and outright banditry. When your force is strong enough, you attack the Citadel of Moorlock in a life or death battle to the finish. Playable in 2 to 5 hours, this one is different every time. 16k TRS-80, TRS-80 Color, and Sinclair. 13K VIC-20. \$14.95 each.



## ADVENTURES!!!

These Adventures are written in BASIC, are full featured, fast action, full plotted adventures that take 30-50 hours to play. (Adventures are interactive fantasies. It's like reading a book except that you are the main character as you give the computer commands like "Look in the Coffin" and "Light the torch.")

Adventures require 16k on TRS80, TRS80 color, and Sinclair. They require 8k on OSI and 13k on Vic-20. Derelict takes 12k on OSI. \$14.95 each.

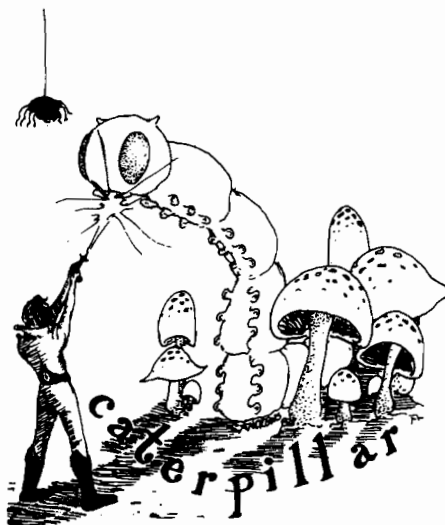

## CATERPILLAR

O.K., the Caterpillar does look a lot like a Centipede. We have spiders, falling fleas, monsters traipsing across the screen, poison mushrooms, and a lot of other familiar stuff. COLOR 80 requires 16k and Joysticks. This is Edson's best game to date. \$19.95 for TRS 80 COLOR.

**PROGRAMMERS!**  
**SEE YOUR PROGRAM IN THIS SPACE!!**  
Aardvark traditionally pays the highest commissions in the industry and gives programs the widest possible coverage. Quality is the keyword. If your program is good and you want it presented by the best, send it to Aardvark.

## ESCAPE FROM MARS

(by Rodger Olsen)

This ADVENTURE takes place on the RED PLANET. You'll have to explore a Martian city and deal with possibly hostile aliens to survive this one. A good first adventure.

## PYRAMID (by Rodger Olsen)

This is our most challenging ADVENTURE. It is a treasure hunt in a pyramid full of problems. Exciting and tough!

## HAUNTED HOUSE (by Bob Anderson)

It's a real adventure—with ghosts and ghouls and goblins and treasures and problems — but it is for kids. Designed for the 8 to 12 year old population and those who haven't tried Adventure before and want to start out real easy.

## DERELICT

(by Rodger Olsen & Bob Anderson)

New winner in the toughest adventure from Aardvark sweepstakes. This one takes place on an alien ship that has been deserted for a thousand years — and is still dangerous!

*Please specify system on all orders*

**ALSO FROM AARDVARK** — This is only a partial list of what we carry. We have a lot of other games (particularly for the TRS-80 Color and OSI), business programs, blank tapes and disks and hardware. Send \$1.00 for our complete catalog.

## AARDVARK - 80

2352 S. Commerce, Walled Lake, MI 48088

(313) 669-3110

Phone Orders Accepted 8:00 a.m. to 4:00 p.m. EST. Mon.-Fri.



## TUBE FRENZY

(by Dave Edson)

This is an almost indescribably fast action arcade game. It has fast action, an all new concept in play, simple rules, and 63 levels of difficulty. All machine code, requires Joysticks. Another great game by Dave Edson. TRS 80 COLOR ONLY. 16k and Joysticks required. \$19.95.



## CATCH'EM

(by Dave Edson)

One of our simplest, fastest, funnest, all machine code arcade games. Raindrops and an incredible variety of other things come falling down on your head. Use the Joysticks to Catch'em. It's a BALL! — and a flying saucer! — and a Flying Y! — and so on. TRS 80 COLOR. \$19.95.

## BASIC THAT ZOOMMS!!

### AT LAST AN AFFORDABLE COMPILER!

The compiler allows you to write your programs in easy BASIC and then automatically generates a machine code equivalent that runs 50 to 150 times faster.

It does have some limitations. It takes at least 8k of RAM to run the compiler and it does only support a subset of BASIC—about 20 commands including FOR, NEXT, END, GOSUB, GOTO, IF, THEN, RETURN, END, PRINT, STOP,USR (X), PEEK, POKE, \*, /, +, -, >, <, =, VARIABLE NAMES A-Z, SUBSCRIPTED VARIABLES, and INTEGER NUMBERS FORM 0-64K.

TINY COMPILER is written in BASIC. It generates native, relocatable 6502 or 6809 code. It comes with a 20-page manual and can be modified or augmented by the user. \$24.95 on tape or disk for OSI, TRS-80 Color, or VIC.



By Loren Wright

### What's So Good About the Commodore 64?

It looks almost exactly like the VIC-20, but the \$595 list price is twice that of the VIC's. There are a few external differences. The color of the case is light tan instead of off-white; the keyboard has a more comfortable feel; there are two controller ports instead of one; the power supply is considerably bigger and connects to a more elaborate jack on the computer; the cartridge port is narrower; the modulator is built into the computer with a deeply recessed channel 3/4 switch.

When you turn on the C64, more differences are apparent. There are 40 columns across, instead of 22, and it comes up with 38911 bytes free — more than ten times that of the VIC! The graphics (see last month's column) and sound capabilities are considerably more advanced than the VIC's. After that, comparison to the VIC is not very useful.

The C64 actually has 64K of RAM, and you do get nearly 8K more for BASIC than you do with a 32K PET. For machine language there's another 8K at \$C000-\$CFFF. However, if you want to strip down the C64's operating system to the essential routines or KERNAL (get a character, put a character, etc.), you can gain access to a lot more RAM for machine-language programs. You can copy the BASIC ROMs into RAM, make changes as you like, and run from the new RAM copy.

The difference is the 6510 processor with its built-in I/O port and tri-state address lines. This allows RAM and ROM to share the same address space, with the processor switching only one in at a time. For instance, the I/O devices (VIC-II, SID, CIA) and color RAM are addressed exactly the same place (\$D000-\$DFFF) as the character generator ROM (not to mention the RAM available there!). The 6510 is able to do all the necessary switching at the right times to pull this off. Unlike the 6509 (to be included in the PET/CBM

B, P, and BX), the addressing range of the 6510 is still only 64K.

It is very encouraging that so much technical information is available on the C64. Before the C64 was released, Commodore had an information kit, including memory maps and development software, available to serious software developers. The *Programmer's Reference Guide* should be available by the time you read this. Unlike Commodore publications before the *VIC Programmer's Reference Guide*, the "Guide" for the C64 is thorough, well done, and very useful.

Availability of software for the C64 is not as much a problem as first anticipated. Most PET programs can be converted easily to run on the C64. Many already have. C64 versions of such popular PET programs as WordPro 3, MAE, and VisiCalc should be available shortly. Over 300 educational programs are now offered by the Toronto PET Users' Group. I have already received review copies of C64 versions of "Tiny BASIC Compiler" from Abacus Software and "KMMM Pascal" from Wilserv Industries (available from AB Computers). There already is a fair amount of public domain software, including some nifty demonstrations, an assembler, a sprite editor, a character editor, and a SID monitor. These started out in Commodore's software developer's kit, but most users' groups should have these by now.

There is some cause for concern in the software area, though. The CP/M and IEEE cartridges have been delayed considerably. If you are counting on CP/M software for the C64 right away, don't hold your breath! Even when the cartridge does become available you will have to have each CP/M disk converted to CBM format.

Commodore has no immediate plans to release an IEEE adaptor, but two (and maybe three when you read this) such units are available from independent vendors. The fanciest unit, called the C64-LINK, sells for \$185 (Canadian) from Richvale Communications (10610 Bayview Avenue, Richmond Hill, Ontario L4C 3N8, Canada). Not only does it interface to the IEEE,

but it also adds BASIC 4 commands and a machine-language monitor. A less elaborate interface is available from Micro-Systems (11105 Shady Trail Suite 104, Dallas, TX 75229) for \$109.95. It provides the IEEE interface only, under control of BASIC 2. A third company in Arizona has announced an IEEE adaptor, still under development. Reviews of the Micro-Systems and Richvale Communications units will appear soon in our "Reviews in Brief" department.

There are a few things I don't like about my new C64. Perhaps the biggest gripe is that as soon as I bought the computer I had to buy more equipment to get a workable system. I was able to get through an orientation period with a feeble, old, black and white TV and a borrowed CBM cassette. The first move was to purchase a C64 Link so I could use the CBM disk and printer from work. Then I bought a color TV. When I get tired of carrying the disk drive back and forth, I'll want my own. All the other computers in the C64's price range are designed in a similar modular fashion, so I must have been spoiled all this time by the PET's completeness! Two other gripes — BASIC 2 and the lack of a machine-language monitor — were solved with the addition of the C64 Link. It would also be nice to have a numeric keypad.

All in all, I'm happy with the purchase. The C64 will satisfy my needs for a computer that is both practical and recreational. I predict it will have a big impact on the market. Apple and Atari will have to make some fast moves to compete.

### PET, VIC, and C64 BASIC Compatibility

If you own more than one Commodore computer, you will eventually want to be able to load programs written on one machine into another. If you are writing programs, your development software and firmware (assembler/editor, disassembler, Toolkit, POWER, etc.) is likely to be concentrated on one machine. Converting a program is usually a simple matter. With the exception of the MAX



## PET Vet *(continued)*

machine, all Commodore computers use essentially the same BASIC. There are slight differences in the control characters implemented (color and programmable function keys on the VIC and C64; screen editing and window controls on the 8032 — unimplemented characters are ignored) and in the screen format (22 VIC columns, 40 for PET and C64, and 80 for 8032). BASIC 4 commands need to be replaced by BASIC 2 commands in the VIC, C64, and earlier PETs. Of course, more serious problems arise with machine-language programs and with BASIC programs that do PEEKs and POKEs to machine-dependent locations.

The cassette format and handling is exactly the same from machine to machine. Even though the VIC disk drive is serial rather than IEEE, the actual diskette can be handled by the PET disk drives (except the 8050).

But even though BASIC programs on these machines are basically compatible, there is a problem. BASIC text starts at different locations in the different machines. In the PET and CBM

models, programs always start at \$401. In an unexpanded VIC it's \$1001, but with the 3K expansion it's \$401. In the C64, BASIC usually starts at \$801. The situation is far from hopeless, though. The VIC and C64 both have relocating loaders: a BASIC program, no matter where it was originally located or from which Commodore machine it was SAVED, will automatically load at the current start of BASIC. The PET/CBM does not have this capability; it loads a program at the original location, but looks for it at \$401. How do we get a program from \$1001 or \$801 to \$401, where the PET expects to find it?

One way is to configure your C64 or VIC so that BASIC programs always start at \$400. For the VIC, you need the 3K RAM expansion that fills in \$400-\$FFF. The VIC automatically adjusts to start BASIC at \$401. For the C64, you need to move the screen to \$8000 (where it is in the PET) and move the start of BASIC to \$401. There is a short program called "C64 to PET" included on the developers' disk mentioned above, that does this.

Another, more general-purpose procedure is outlined below. It works with all

but the very longest BASIC programs.

1. Type a one-line program into your PET (e.g., 1 REM)
2. Load the VIC or C64 program.
3. POKE 1025,1: POKE 1026,8 to move a program from \$801. Or, POKE 1025,1:POKE 1026,16 to move a program from \$1001.
4. Delete the original single line by typing its number, hit return, and the whole program will move to \$401!

### New Users' Group and Newsletter for the SuperPET

The SuperPET Users' Group (SPUG) is putting out a newsletter called the *SuperPET Gazette*. Membership is \$10/year and includes a subscription.

Paul V. Skipski, Secretary  
SuperPET Users' Group  
4782 Boston Post Road  
Pelham, NY 10803

The second issue was ten pages and included resource information, utility programs, and statements of purpose and direction.

MICRO™

## PET / CBM™ SOFTWARE SELECT!

**8032**      OR      **4032**  
DISPLAY                      DISPLAY

FROM THE KEYBOARD OR PROGRAM  
NOW RUN WORD PRO 3 OR WORD PRO 4

### FROM THE SAME MACHINE

Available for either 4000 or 8000 Series

ALSO:

For **2001 / 3000** Series Computers

Operate these Models in a Full **8032** Like  
Display For Word Pro 4\*

and all other 80 Column Software

All installation instructions included.

### EXECOM CORP.

1901 Polaris Ave.  
Racine, WI 53404  
Ph. 414-632-1004

PET/CBM a trademark of Commodore Business Machines  
\*trademark of Professional Software, Inc.

## NEW SOFTWARE for TRS 80 Model III and the Color Computer

### ■ Church Contribution System

designed to simplify and facilitate the tedious chore of recording envelopes. Provides a variety of reports. Maintains its own data-files.      Only **\$150**

### ■ Data Base Manager

designed to help organize all your data and provide you with meaningful reports. Add or delete any information. New files can be created and old information transferred.      Only **\$150**

### ■ Single Entry Ledger

designed as an uncomplicated control of finances for home or small business. Add, delete, edit at any time. Compatible with DBM.      Only **\$95**

Write or phone for complete software price list.



Dept. MI 2  
2457 Wehrle Drive  
Amherst, NY 14221  
716/631-3011

# Extending Newton-Raphson's Method to Evaluate Complex Roots

by P.P. Ong

**This article discusses a standard procedure to compute the complex roots of a polynomial equation using the microcomputer. The accompanying program can be incorporated as a subroutine for applications programs. An extension to cover non-polynomial equations is also discussed.**

## N-R's Method

requires:

Any Microsoft BASIC  
(although written in Applesoft)

Many scientific and engineering applications require handling complex numbers and computing the complex roots of equations. Common practical examples involving complex quantities occur in wave attenuation calculations, solutions of differential equations, alternating current network, Fourier transformation, diffraction pattern analyses, and plane vector algebra. Most microcomputers are, as yet, not designed to handle complex numbers. Indeed, complex numbers are generally not covered in the standard or extended BASIC languages. Users wishing to modify a language to include such quantities invariably encounter an almost insuperable obstacle posed by the limited RAM capacity of the microcomputer. This seems a drawback, especially since the computations involve an iterative procedure for which the computer would be very efficient otherwise.

An illuminating consequential trend is found in the usage of the well-known Newton-Raphson numerical procedure to solve an algebraic equation. With the widespread use of the micro, this

method has become so popular that it has by and large superseded the more conventional method of resorting to complicated mathematics to produce exact solutions. The greater accuracy of the latter method is not always required for real-life problems; in any case, there is often no possible solution by the exact method.

A standard Newton-Raphson procedure for complex roots is also available [e.g., see W.E. Grove, *Brief Numerical Methods*, Prentice-Hall [1966], pp. 9-14], yet it is seldom used in practice. This is because the numerical evaluations usually become too protracted and rarely conclude successfully. In fact, very few textbooks on numerical analysis treat complex root evaluations seriously.

I have developed a system to extend Newton-Raphson's method using de Moivre's theorem. It is now my standard routine and is applicable for both real and complex roots of any polynomial equation with real coefficients. The computer itself does not need to handle complex quantities — only standard trigonometric functions such as sine, cosine, and arc tangent, which are all built-in BASIC functions.

A detailed mathematical formulation is presented for those who want to know why the method works, but this section may be by-passed in a first reading.

## Mathematical Formulation

Suppose a polynomial equation of degree  $n$  and having only real coefficients is given. It can be written in the form

$$(1) F(x) = a_0 + a_1x + a_2x^2 + \dots + a_nx^n$$

Its derivative is

$$(2) F'(x) = a_1 + 2a_2x + 3a_3x^2 + \dots + na_nx^{n-1}$$

Newton-Raphson's iteration formula is

$$(3) x_{k+1} = x_k - \{F(x_k)/F'(x_k)\}$$

Put

$$(4) x_k = p + qi = A(\cos \theta + i \sin \theta) = Ae^{i\theta}$$

so that

$$(5) A = \text{SQR}(p^2 + q^2)$$

and

$$(6) \theta = \begin{cases} \tan^{-1}(q/p) & \text{for } p \neq 0 \text{ or } q = 0 \\ \pi/2 & \text{for } p = 0 \text{ and } q > 0 \\ -\pi/2 & \text{for } p = 0 \text{ and } q < 0 \end{cases}$$

The case  $x_k = p = q = 0$  is obviously trivial. To calculate the angular value of the arc tangent, care must be taken to ensure that it lies in the first quadrant for  $p > 0$  and  $q > 0$ , in the second quadrant for  $p < 0$  and  $q > 0$ , in the third quadrant for  $p < 0$  and  $q < 0$ , and in the fourth quadrant for  $p > 0$  and  $q < 0$ .

Using de Moivre's theorem

$$(7) x_k^m = A^m(\cos m\theta + i \sin m\theta)$$

we can re-write equation (3) as

$$(8) x_{k+1} = x_k - \{ (r + si)/(t + ui) \}$$

where

$$(9) r = a_0 + a_1A\cos\theta + a_2A^2\cos^2\theta + \dots + a_nA^n\cos^n\theta$$

$$(10) s = a_1A\sin\theta + a_2A^2\sin^2\theta + a_3A^3\sin^3\theta + \dots + a_nA^n\sin^n\theta$$

$$(11) t = a_1 + 2a_2A\cos\theta + 3a_3A^2\cos^2\theta + \dots + na_nA^{n-1}\cos^{n-1}\theta$$

$$(12) u = 2a_2A\sin\theta + 3a_3A^2\sin^2\theta + \dots + na_nA^{n-1}\sin^{n-1}\theta$$

From equation (8) the correction term is

$$(13) x_{k+1} - x_k = -b\{\cos(\Phi - \psi) + i \sin(\Phi - \psi)\}$$

where

$$(14) \Phi = \begin{cases} \tan^{-1}(s/r) & \text{for } r \neq 0 \text{ or } s = 0 \\ \pi/2 & \text{for } r = 0 \text{ and } s > 0 \\ -\pi/2 & \text{for } r = 0 \text{ and } s < 0 \end{cases}$$

and

$$(15) \psi = \begin{cases} \tan^{-1}(u/t) & \text{for } t \neq 0 \text{ or } u = 0 \\ \pi/2 & \text{for } t = 0 \text{ and } u < 0 \\ -\pi/2 & \text{for } t = 0 \text{ and } u > 0 \end{cases}$$

and

$$(16) b = \text{SQR}\{(r^2 + s^2)/(t^2 + u^2)\}$$

Again, to compute the angles from the respective inverse tangent functions the proper angular quadrants have to be found. In equation (14) [the special case when  $r=s=0$  results in  $x_{k+1}=x_k$ ] the solution is obviously obtained.

Equation (16) breaks down if both  $t$  and  $u$  vanish. This occurs when  $F'(x) = 0$  and Newton-Raphson's method fails in this case. The computation has to be restarted with a different initial value for  $x_k$ .

Barring the above abortive case, the iteration procedure continues with  $x_{k+1}$  replacing  $x_k$ . The new values of  $p$  and  $q$  become

$$(17) p \rightarrow p - b \cos(\Phi - \psi)$$

and

$$(18) q \rightarrow q - b \sin(\Phi - \psi)$$

Since complex roots occur in pairs for a polynomial with real coefficients, when one complex root is found its complex conjugate would also be a root. Furthermore, if  $x = p \pm qi$  is a pair of complex roots, then  $F(x)$  has a quadratic factor

$$(19) (x - p)^2 + q^2 = x^2 - 2px + (p^2 + q^2)$$

If a real root is found then  $q = 0$  and  $F(x)$  has a linear factor  $(x - p)$ . By successive factorization of  $F(x)$  we can reduce the degree of the polynomial equation by one or two each time, and eventually all its roots can be obtained completely.

## The Program

The above formulation is translated into a sub-program written explicitly in Applesoft BASIC. It can be readily modified to adapt to other micro systems. To assist the reader, the program is liberally filled with explanatory REMarks at each stage. It can be segmented at statement numbers 50000, 51000, 52000, etc. The leading statement of each segment clearly describes the purpose of the segment.

Because of the nature of the problem, there are an inconveniently large number of initial parameters that need to be supplied by the user. To minimize this, default values are automatically chosen whenever possible. The exact parameters describing the given equation must obviously be supplied by the user. All the other parameters are defaulted as follow:

- a. Maximum iteration number allowed, IM = 30
  - b. Maximum error tolerance allowed, ER = 1E-8
  - c. Initial approximation of root: real part, P = 1; imaginary part, Q = i
- Provision is available to re-select these defaulted values, especially after an unsuccessful iteration.

Since there is an inherent rounding error associated with any floating-point number, a perceptible, though normally small, error will be propagated after a large number of computation steps. This magnification of errors is roughly proportional to the degree of the polynomial, the coefficients, and the number of high-power terms involved. After many successive factorizations it is possible for the roots subsequently obtained to be off by approximately 0.0001% [see example 1]. Although this discrepancy is usually negligible, a recourse is automatically provided in the program by going through a second stage re-computation of the original equation using each of the previously obtained results as starting approximation. This should eventually lead to new results with the originally stipulated accuracy.

The program is easily incorporated as a BASIC subroutine for any applications program. If necessary, it can first be renumbered (using the Applesoft Toolkit's LOADAPA, for instance), and then appended at the end of the user's application package. It is for this reason that the statement numbers are started high up at 50000, providing ample room for insertion of the user's master

program. To access the subroutine replace its last END statement with a RETURN and call it with a GOSUB. Alternatively, it is also possible for the program to be SAVED on a disk file and EXECed when required.

## Applications

Two examples that demonstrate the application of the program are given below:

### Example 1

Suppose you wish to find the intersections between the curves

$$(20) y = 16 + 7x^5 - 13x^{11} + x^{13} + x^{14}$$

and

$$(21) y = 12 - x + 5x^2 + 26x^3 + 2x^{12}$$

in a Cartesian coordinate system. This is equivalent to solving the complicated algebraic equation

$$(22) 4 + x - 5x^2 - 26x^3 + 7x^5 - 13x^{11} - 2x^{12} + x^{13} + x^{14} = 0$$

Ordinarily this problem would be too formidable to attempt manually. However, with the present program the following set of answers [all accurate to seven decimal places] was printed on the screen in just over nine minutes (including a 15-second pause for screen reading after each successful iteration):

$$\begin{aligned} x = & 0.5100436, -0.3318626 \pm \\ & 0.4413179i, 1.0542850 \pm \\ & 0.3956750i, 0.5187938 \pm \\ & 0.9907267i, -0.9420515 \pm \\ & 0.3670825i, 2.1458455, \\ & -0.3315892 \pm 1.0217258i, \\ & -1.7955200 \pm 1.7664781i \end{aligned}$$

As an aside, it is worth noting that after the first-stage computation the last set of roots was  $x = -1.7955314 \pm 1.7664794i$ , which differed from the exact answers by about 1 part in  $10^6$ . The accumulated propagated error in this illustration was 0.0001% — minimal considering the elaborate computations involved.

### Example 2

Now try to solve the linear differential equation

$$(23) \frac{d^{10}y}{dx^{10}} - 0.77 \frac{d^6y}{dx^6} - 7.9 \frac{d^6y}{dx^6} + 1.44 \frac{d^4y}{dx^4} + 5.18 \frac{d^2y}{dx^2} - 4.275 = 0$$

```

10 REM *****
11 REM * *
12 REM * EXTENDING NEWTON- *
13 REM * RAPHSON'S METHOD *
14 REM * TO EVALUATE COMPLEX *
15 REM * ROOTS *
16 REM * *
17 REM * P. P. ONG *
18 REM * *
19 REM * *
20 REM *****
50000 TEXT : HOME
50020 PRINT : PRINT 'THIS SUBR COMPUTES THE REAL AND COMPLEX'
50040 PRINT 'ROOTS OF ANY POLYNOMIAL EQUATION:': PRINT
50060 PRINT 'F(X)=A(0)+A(1)X+A(2)X^2+...+A(N)X^N'
50080 PRINT : INVERSE : PRINT 'SPECIFY THE FOLLOWING INPUTS:': NORMAL
50100 PRINT : INPUT 'N = ':N: DIM A(N),SG$(N),AA(N),P(N),Q(N):NN = N
50120 FOR I = 0 TO N
50140 PRINT 'A('I') = ':; INPUT '':A(I):AA(I) = A(I): NEXT
50160 PRINT
50180 ER = 1E - 8: REM Set Error Tolerance
50200 IM = 30: REM Set Max.Iter.No.
50220 RT = 0: REM Init Root Counter
50240 PI = 3.141592654:FL = 0: REM Init Recomputation Flag
50260 PL$ = '+':MN$ = '-':
50280 PRINT : INPUT 'DEFAULT FOR OTHER PARAMETERS? ':ANS: IF LEFT$(
(ANS,1) = 'N' THEN PRINT : PRINT : GOTO 59040
50300 IF N = 1 THEN GOSUB 58000
50320 IF N = 0 THEN GOTO 60000
50340 P = 1:Q = 1: REM SET FIRST ITER.VALUE OF X
50360 IR = 0: GOSUB 56000
51000 IR = IR + 1: REM Begin Iter.Loop
51020 IF IR > IM THEN 59020
51040 REM Compute A and Theta
51060 A = SQR (P * P + Q * Q)
51080 IF Q = 0 THEN Q = ER * ER: REM Make Abs(Q) <> 0
51100 IF P = 0 THEN TH = PI / 2 * SGN (Q): GOTO 51200
51120 TH = ATN (Q / P)
51140 REM Compute The Proper Quadrant For Theta
51160 IF TH < 0 THEN TH = TH + PI
51180 IF TH < PI AND Q < 0 THEN TH = TH + PI
51200 R = A(0): REM Begin Compute R
51220 FOR I = 1 TO N:R = R + A(I) * A ↑ I * COS (I * TH): NEXT
51240 S = 0: REM Begin Compute S
51260 FOR I = 1 TO N:S = S + A(I) * A ↑ I * SIN (I * TH): NEXT
51280 T = 0: REM Begin Compute T
51300 FOR I = 1 TO N:T = T + I * A(I) * A ↑ (I - 1) * COS ((I - 1)
* TH): NEXT
51320 U = 0: REM Begin Compute U
51340 FOR I = 2 TO N:U = U + I * A(I) * A ↑ (I - 1) * SIN ((I - 1)
* TH): NEXT
51360 IF T = 0 AND U = 0 THEN 59340
51380 B = SQR ((R * R + S * S) / (T * T + U * U))
51400 IF B < ER THEN 52000
51420 REM Compute Phi and Psi
51440 IF R = 0 THEN FI = PI / 2 * SGN (S): GOTO 51540
51460 FI = ATN (S / R)
51480 REM Compute the Proper Quadrant for Phi
51500 IF FI < 0 THEN FI = FI + PI
51520 IF FI < PI AND S < 0 THEN FI = FI + PI
51540 IF T = 0 THEN SI = PI / 2 * SGN (U): GOTO 51640
51560 SI = ATN (U / T)
51580 REM Compute the Proper Quadrant For Psi
51600 IF SI < 0 THEN SI = SI + PI
51620 IF SI < PI AND U < 0 THEN SI = SI + PI
51640 REM Set New P and Q
51660 P = P - B * COS (FI - SI):Q = Q - B * SIN (FI - SI)
51680 IF FL = 1 THEN 51000: REM Don't Print on Recomputation
51700 PRINT 'I=' SPC (IR < 10);IR: SPC (2) 'P='P: TAB (24) 'Q='Q:
REM Print Result After Each Iter.
51720 GOTO 51000
52000 REM Successful Iteration
52020 RT = RT + 1: REM Count the No. of Sets of Roots
52040 P(RT) = P:Q(RT) = Q: REM Store Answers
52060 IF FL = 1 THEN RETURN
52080 PRINT : PRINT 'NR'S METHOD IS SUCCESSFUL.'
52100 ON (1 + (ABS (Q) < ER)) GOSUB 53000,55000: GOSUB 50300
53000 REM Routine for Complex Roots
53020 PRINT : PRINT 'A PAIR OF COMPLEX ROOTS ARE'
53040 PRINT : PRINT 'X = 'P' (+/-) 'ABS (Q)' * I': PRINT
53060 FOR I = 1 TO 3000: NEXT
54000 N = N - 2: REM Reduce Polyn Degree by 2
54020 IF N = 0 THEN RETURN
54040 H = - 2 * P:K = P * P + Q * Q

```

```

54060 REM Reset Coeffs of F(X) After Extracting the Factor (Xx+Hx+K)
54080 A(0) = A(0) / K
54100 A(1) = (A(1) - H * A(0)) / K
54120 IF N = 1 THEN RETURN
54140 FOR I = 2 TO N
54160 A(I) = (A(I) - H * A(I - 1) - A(I - 2)) / K
54180 NEXT : RETURN
55000 REM Routine for Real Root
55020 PRINT : PRINT 'A SINGLE REAL ROOT FOUND IS'
55040 PRINT : PRINT 'X = 'P
55060 FOR I = 1 TO 3000: NEXT
55080 N = N - 1: REM Reduce Polyn Degree by 1
55100 IF N = 0 THEN RETURN
55120 REM Reset Coeffs of F(X) After Extracting the Factor (X-P)
55140 A(0) = - A(0) / P
55160 FOR I = 1 TO N
55180 A(I) = - (A(I) - A(I - 1)) / P: NEXT
55200 RETURN
56000 HOME : REM Display Screen Heading
56020 PRINT '=====': PRINT
: PRINT
56040 PRINT 'NOW COMPUTING....'
56060 FOR I = 0 TO N:SG$(I) = PL$
56080 IF A(I) < 0 THEN SG$(I) = MN$
56100 NEXT
56120 PRINT : PRINT 'F(X) = ':;
IF A(0) < > 0 THEN PRINT A(0);
56140 IF A(1) < > 0 THEN PRINT SG$(1); ABS (A(1)) 'X';
56160 IF N < 2 THEN PRINT : PRINT : GOTO 56240
56180 FOR I = 2 TO N: IF A(I) < > 0 THEN PRINT SG$(I);
ABS (A(I)) 'X^I';
56200 NEXT : PRINT
56220 PRINT : PRINT 'WITH ER = 'ER' AND IM = 'IM: PRINT
56240 PRINT '-----': PRINT : RETURN
57000 REM Restore Original F(X)
57020 N = NN: FOR I = 0 TO NN:A(I) = AA(I): NEXT : RETURN
58000 REM Compute Root of Residual Linear Fraction
58020 RT = RT + 1:P(RT) = - A(0) / A(1)
58040 GOSUB 56000: PRINT : PRINT 'LAST ROOT (REAL) = 'P(RT)
58060 FOR I = 1 TO 3000: NEXT
58080 N = N - 1: RETURN
59000 REM Unsuccessful Cases
59020 HOME : PRINT 'MAX ITER. NO. EXCEEDED': PRINT : PRINT
59030 POKE 34,3
59040 P = 1:Q = 1: REM Offset P and Q
59060 HOME : PRINT 'TYPE 1 TO RESELECT MAX ITER NO.': PRINT
59080 PRINT 'TYPE 2 TO RESELECT ERR TOLERANCE': PRINT
59100 PRINT 'TYPE 3 TO RESELECT INIT APROX. ROOT': PRINT
59120 PRINT 'TYPE 4 TO RECOMPUTE': PRINT
59140 PRINT 'TYPE 5 TO ABORT AND DISPLAY ROOTS'
59160 PRINT ' OBTAINED SO FAR'
59170 POKE 34,0
59180 PRINT : GET CH$: PRINT : ON VAL (CH$) GOTO 59220,59240,59260,
50360,59320
59200 GOTO 59180
59220 INPUT 'NEW MAX ITER NO. = ':IM: GOTO 59060
59240 INPUT 'NEW ERR TOLERANCE = ':ER: GOTO 59060
59260 PRINT 'SUPPLY THE INIT APPROX OF ROOT BY'
59280 PRINT 'TYPING IN ITS REAL AND IMAG PARTS'
59300 PRINT '(SEPARATED BY A COMMA): ': INPUT '':P,Q: PRINT : PRINT :
GOTO 59060
59320 PRINT : PRINT 'COMPUTATION ABORTED.': PRINT : PRINT 'LISTING OF
ROOTS OBTAINED SO FAR:--': GOSUB 60200: END
59340 REM Case Where T=U=0
59360 PRINT : PRINT 'F(X)=0 AND NR'S METHOD FAILS'
59380 PRINT : PRINT 'RESELECT FIRST APPROX OF ROOT': PRINT : GOTO 59260
60000 REM Compute to Minimize Propagation Errors
60020 GOSUB 57000
60040 FL = 1:RM = RT:RT = 0
60060 HOME : PRINT 'PRELIMINARY LISTING OF ROOTS OF EQU.:--'
60080 GOSUB 60200: INVERSE : PRINT ' PLEASE WAIT FOR RECOMPUTED RESULTS
': NORMAL
60100 P = P(RT + 1):Q = Q(RT + 1)
60120 IR = 0: GOSUB 51000: IF RT < RM THEN 60100: REM Compute Next Root
60140 REM Conclude and Display Summary Results
60160 PRINT CHR$(12)
60180 HOME : PRINT 'FINAL LISTING OF ROOTS OF EQUATION:--': GOSUB 60200:
GOTO 60300
60200 GOSUB 56060: PRINT
60220 FOR I = 1 TO RM: PRINT 'X = ':; IF ABS (P(I)) > ER THEN PRINT
P(I);
60240 IF ABS (Q(I)) > ER THEN PRINT ' (+/-) 'ABS (Q(I))' * I';
60260 PRINT : PRINT
60280 NEXT : PRINT '=====': RETURN
60300 END

```

First try the solution

$$(24) y = Ae^{kx}$$

where A and k are constants. By direct substitution and dividing the resulting equation throughout by  $-Ae^{kx}$  you will obtain

$$(25) k^{10} + 0.77k^8 - 7.9k^6 - 1.44k^4 + 5.18k^2 + 4.275 = 0$$

The computer took four minutes to complete the first-stage computation and a further 45 seconds for the second stage to produce the answers:

$$k = \pm 0.2692324 \pm 0.8097208i, \pm 1.5266484, \pm 1.0626761, \pm 1.7503178i$$

The general solution to equation (23) is therefore

$$(26) y = A_1 \exp(k_1 x) + A_2 \exp(k_2 x) + \dots + A_{10} \exp(k_{10} x)$$

where the A's are the ten integration constants and the k's are the respective real or complex roots obtained.

### The Results

There is no problem of unattainable accuracy up to the limits of the accuracy of the computer. The computer merely must perform extra iterations to achieve the desired results. Convergence is usually very rapid except in regions of x where  $F'(x)$  is very small — a general defect of the Newton-Raphson method. To safeguard against this rare eventuality the computer prints the answers after each stage of iteration so that a quick visual inspection can be made. When this occurs a simple remedy is to re-run the program with a different initial trial root.

In the hundreds of equations I have solved using this method I have seldom found it unworkable. I'll leave it to the experts to do a rigorous analysis of the convergence and stability, or otherwise, of the iteration. It is enough to mention that the method will be inaccurate only if both the equations  $F(x)=0$  and  $F'(x)=0$  happen to share the same root. At the same time, a very high level of accuracy approaching the computer's own accuracy limits (e.g.,  $ER < 10^{-6}$ ) is expected. For example, when

$$(27) F(x) = (1 + x^2)^2 = 1 + 2x^2 + x^4 = 0$$

which has the same roots  $x = \pm i$  as

$$(28) F'(x) = 4x(1 + x^2) = 0$$

is input with the error tolerance set at  $ER = 0.000001$  the machine settles down to the slightly imperfect result of

$$x = 1.89330634E-06 \pm i$$

### Conclusion

A general routine has been established that may be used to compute for both the complex and real roots of any polynomial equation. The routine itself does not involve complex numbers and is therefore appropriate for application on a microcomputer (or even a programmable calculator).

By going through two rounds of computations, residual errors propagated over the numerous computation stages can be eliminated, thereby ensuring the stipulated accuracy of the final results. The routine can also be incorporated in applications programs and called as a general subroutine.

The method described can be extended to equations involving simple trigonometric, hyperbolic, or transcendental functions provided such a function can be expanded as a convergent power series and approximated to a polynomial by truncating at some arbitrary power. Such series are convergent only for  $ABS(x) < 1$ . For cases where  $ABS(x) < 1$  a reciprocal transformation  $y=1/x$  can often be tried successfully.

Dr. P.P. Ong has a Ph.D. in ionic physics from University College London. He is employed as a senior lecturer in the Department of Physics, National University of Singapore, and is a member of Institution of Electrical Engineers London. You may contact Dr. Ong at the Physics Department, National University of Singapore, Kent Ridge, Singapore, 0511.

**MICRO**

## AIM + POWER

from **COMPUTECH**

All prices  
**Postpaid**  
(Continental  
U.S. —  
otherwise  
\$2 credit)

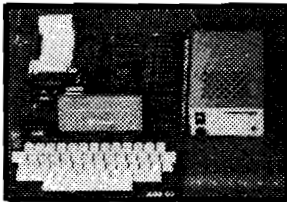

Check the  
**outstanding  
documentation**  
supplied with  
AIM65

**Top quality** power supply designed to Rockwell's specs for fully populated AIM 65 — includes overvoltage protection, transient suppression, metal case and power cable:

PSSBC-A (5V 2A Reg; 24V .5A Avg, 2.5A Peak, Unreg) ...**\$64.95**  
Same but an extra AMP at 5 volts to drive your extra boards:  
PSSBC-3 (5V 3A Reg; 24V .5A Avg, 2.5A Peak, unreg) ...**\$74.95**

The **professional's** choice in microcomputers:

AIM65/1K RAM . . . . .	<b>\$429.95</b>	BASIC (2 ROMS) . . . . .	<b>\$59.95</b>
AIM65/4K RAM . . . . .	<b>\$464.95</b>	ASSEMBLER (1 ROM) . . .	<b>\$32.95</b>
		FORTH (2 ROMS) . . . . .	<b>\$59.95.</b>

**SAVE EVEN MORE ON COMBINATIONS**

AIM65/1K + PSSBC-A . **\$479.95**    AIM65/4K + PSSBC-3 . **\$524.95**

We gladly quote on all AIM65/40 and RM65 items as well.

**ORDERS: (714) 369-1084**

P.O. Box 20054 • Riverside, CA 92516

California residents add 6% sales tax





BOX 120  
ALLAMUCHY, N.J. 07820  
201-362-6574

**HUDSON DIGITAL ELECTRONICS INC.**

## THE TASK\* MASTERS

HDE supports the \*TIM, AIM, SYM and KIM (TASK) with a growing line of computer programs and peripheral components. All HDE component boards are state-of-the-art 4½" x 6½", with on board regulation of all required voltages, fully compatible with the KIM-4 bus.

### **OMNIDISK 65/8 and 65/5**

Single and dual drive 8" and 5¼" disk systems. Complete, ready to plug in, bootstrap and run. Include HDE's proprietary operating system, FODS (File Oriented Disk System).

### **DM816-M8A**

An 8K static RAM board tested for a minimum of 100 hours and warranted for a full 6 months.

### **DM816-UB1**

A prototyping card with on-board 5V regulator and address selection. You add the application.

### **DM816-P8**

A 4/8K EPROM card for 2708 or 2716 circuits. On board regulation of all required voltages. Supplied without EPROMS.

### **DM816-CC15**

A 15 position motherboard mounted in a 19" RETMA standard card cage, with power supply. KIM, AIM and SYM versions.

### **DISK PROGRAM LIBRARY**

Offers exchange of user contributed routines and programs for HDE Disk Systems. Contact Progressive Computer Software, Inc. for details.

### **HDE DISK BASIC**

A full range disk BASIC for KIM based systems. Includes PRINT USING, IF ... THEN ... ELSE. Sequential and random file access and much more. \$175.00

### **HDE ADVANCED INTERACTIVE DISASSEMBLER (AID)**

Two pass disassembler assigns labels and constructs source files for any object program. Saves multiple files to disk. TIM, AIM, SYM, KIM versions. \$95.00

### **HDE ASSEMBLER**

Advanced, two pass assembler with standard mnemonics. KIM, TIM, SYM and KIM cassette versions. \$75.00 (\$80.00 cassette)

### **HDE TEXT OUTPUT PROCESSING SYSTEM (TOPS)**

A comprehensive text processor with over 30 commands to format and output letters, documents, manuscripts. KIM, TIM and KIM cassette versions. \$135.00 (\$142.50 cassette)

### **HDE DYNAMIC DEBUGGING TOOL (DDT)**

Built in assembler/disassembler with program controlled single step and dynamic breakpoint entry/deletion. TIM, AIM, SYM, KIM AND KIM cassette versions. \$65.00 (\$68.50 cassette)

### **HDE COMPREHENSIVE MEMORY TEST (CMT)**

Eight separate diagnostic routines for both static and dynamic memory. TIM, AIM, SYM, KIM and KIM cassette versions. \$65.00 (\$68.50 cassette)

### **AVAILABLE DIRECT OR FROM THESE FINE DEALERS:**

Progressive Computer Software  
405 Corbin Road  
York, PA 17403  
(717) 845-4954

Johnson computers  
Box 523  
Medina, Ohio 44256  
(216) 725-4560

Falk-Baker Associates  
382 Franklin Avenue  
Nutley, NJ 07110  
(201) 661-2430

Perry Peripherals  
P.O. Box 924  
Miller Place, NY 11764  
(516) 744-6462

Lux Associates  
20 Sunland Drive  
Chico, CA 95926  
(916) 343-5033

Laboratory Microcomputer Consultants  
P.O. Box 84  
East Amherst, NY 14051  
(716) 689-7344



# Signed Binary Multiplication is Unsigned

by Timothy Stryker

**Two's complement notation has surprises in store for those writing integer multiplication routines. A little mathematical analysis shows why.**

**Multiplication Routine**  
requires:  
6502 computer

Most programmers writing a signed-integer multiplication routine in assembly language would write it in what they consider the most straightforward manner. That is, they would find the absolute values of the multiplicand and the multiplier, multiply them together, and then adjust the sign of the product based on whether the signs of the original multiplicand and multiplier were or were not the same.

It is a little-known fact of binary life that this method is not necessary in certain circumstances. In particular, if you plan to make the number of bits of precision in the product equal to the number of bits of precision in the input factors, then the nature of two's complement arithmetic causes the sign computations to come out right without any need for explicit sign handling on your part. Under these conditions, there is *no difference* between a signed and an unsigned integer multiplication routine. This applies whether you use a shift-and-add algorithm, Booth's algorithm, or any other basic multiplication algorithm.

Most programmers will snort in derision at such a proposition — it seems to run counter to all logic. The idea that, in the case of 16-bit numbers for example, multiplying a number by 2 and then inverting it should give the same result as multiplying it by 65534, ignoring all but the low-order 16 bits of the product, seems ludicrous. Nevertheless, that is the case. This article discusses why.

Remember that when you encode a negative integer in two's complement notation, you are actually using the sum of that number with 2 to the power of the number of bits in your word. In mathematical terms, you are encoding  $-n$  as

$$2^m + (-n)$$

where  $m$  is the number of bits in the word. When you add a pair of two's complement numbers together, the reason that you don't have to special-case their signs is that you ignore all

but the low-order  $m$  bits of the sum. Since any  $2^m$  terms in the sum contribute only to bit positions above the  $m$ -th, these low-order  $m$  bits give you the right result. For example, adding 5 to  $-3$  gives you

$$5 + 2^m - 3 = 2^m + 5 - 3 = 2^m + 2$$

the low-order  $m$  bits of which represent a 2. Adding  $-6$  to  $-4$  gives you

$$2^m - 6 + 2^m - 4 = 2 \cdot 2^m - 6 - 4 = 2 \cdot 2^m - 10$$

Listing 1

OBJECT	ASSEMBLY SOURCE
	* MULT:
	* * EXPECTS TO BE CALLED WITH TWO 16-BIT FACTORS * ON THE STACK: MULT REPLACES THEM WITH THEIR * 16-BIT PRODUCT AND RETURNS. THE FACTORS AND * THEIR PRODUCT MAY BE THOUGHT OF AS EITHER * SIGNED OR UNSIGNED, IT MAKES NO DIFFERENCE. * * MULT IS RELOCATABLE AND USES NO SCRATCHPAD * MEMORY, ZERO-PAGE OR OTHERWISE. * * BY T. STRYKER 4/82 (WITH THANK AND A TIP OF * THE HAT TO C. GUILMARTIN AND K. WASSERMAN) *
A9 00	MULT LDA #0 INITIALIZE PRODUCT TO 0
48	PHA
48	PHA
BA	TSX SET UP FOR STACK INDEXING
A0 10	LDY #16 DO SHIFT-AND-ADD 16 TIMES
5E 08 01	MLOOP LSR \$108,X SHIFT FIRST FACTOR RIGHT
7E 07 01	ROR \$107,X
90 13	BCC SHIFT BRANCH IF ZERO SHIFTED OUT
18	CLC ADD LEFT-SHIFTED SECOND
BD 01 01	LDA \$101,X FACTOR TO PRODUCT
7D 05 01	ADC \$105,X
9D 01 01	STA \$101,X
BD 02 01	LDA \$102,X
7D 06 01	ADC \$106,X
9D 02 01	STA \$102,X
1E 05 01	SHIFT ASL \$105,X SHIFT SECOND FACTOR LEFT
3E 06 01	ROL \$106,X
88	DEY DONE YET?
D0 DC	BNE MLOOP BRANCH BACK IF MORE TO DO
68	PLA REPLACE FIRST FACTOR
9D 07 01	STA \$107,X WITH PRODUCT
68	PLA
9D 08 01	STA \$108,X
68	PLA REPLACE SECOND FACTOR
9D 05 01	STA \$105,X WITH RETURN ADDRESS
68	PLA
9D 06 01	STA \$106,X
60	RTS AND RETURN

the low-order  $m$  bits of which are equal to simply  $2^m - 10$ , namely,  $-10$ .

Now consider what happens when you multiply. The case in which both factors are positive need not be considered. The case in which one factor,  $f$ , is positive and the other,  $-g$ , negative, gives you

$$f * (2^m - g) = f * 2^m - f * g$$

which, ignoring bit positions above the  $m$ -th, is none other than  $-(f * g)$ . Similarly, the case in which both factors,  $-f$  and  $-g$ , are negative, gives you

$$(2^m - f) * (2^m - g) = 2^m * (2^m - f - g) + f * g$$

which, ignoring a rather large amount of gibberish above the  $m$ -th bit position, is simply  $f * g$ , as expected.

Listing 1 shows a relocatable 16-bit signed/unsigned integer multiplication routine for the 6502 that takes its arguments from the stack, pops them, and returns their product on the stack. It could be written more efficiently, of course — I have written it this way to make it completely machine-independent. Remember, though, that this approach does have definite limitations: in general, the multiplication of one 16-bit integer by another will yield a 32-bit product. Thus, a routine like the one shown is only applicable in cases where the product is known to fit in 16 bits (languages like RPL and FORTH, for example, typically make this assumption).

The approach given here could be economically applied in a fully general signed multiplication procedure on a processor possessing a hardware sign-extend operation. It would then be necessary only to sign-extend each 16-bit input factor to 32 bits before doing the multiply, yielding a fully general 32-bit result. Unfortunately, this finding does not apply to signed division. At any rate, whether useful to you or not, the above is certainly a surprising and illuminating result. There is more elegance and consistency lurking within the concept of two's complement notation than most of us realize.

Timothy Stryker may be contacted at Samurai Software, P.O. Box 2902, Pompano Beach, FL 33062.

# MICRObits

Deadline for MICRObits: 20th of second month before publication; i.e., January 20th for March issue. Send typewritten copy (40-word limit) with \$25.00 per insertion. (Subscribers: first ad at \$10.00.)

## 6800/6809 Software

Includes compatible single-user, multi-user and network-operating systems, compilers, accounting and word processing packages. Free catalog.

Software Dynamics  
2111 W. Crescent, Sta. C  
Anaheim, CA 92801

## Lessons in Algebra

An easy and fun way to learn the basic elements of high school algebra. Apple computer diskette \$29.95. 30-day money-back guarantee if not satisfied.

George Earl  
1302 So. General McMullen Dr.  
San Antonio, TX 78237

## Dynamite PET/CBM Accessories!

Write-protect switches/indicators for 2040/4040 disk drives. Real world software at low cost. 2114 RAM adapter (replaces obsolete 6550's) and 4K memory expansion for "old" 8K PETs. Hundreds of satisfied customers. Write for free catalog!

Optimized Data Systems  
Dept. M, Box 595  
Placentia, CA 92670

## Apple II Data Converter

Includes: 1. 6522 VIA board, 2. external ADC/DAC module: ADC-17,000 samples/s, 0.1mV-9V AC/DC; DAC-33,000 points/s, 0-2.56V; amplifier, speaker, and 3. software on disk. \$149.00 kit; \$199.00 assembled and tested.

NALAN Computer Specialties  
Dept. M  
106 Highland Park Lane  
Boone, NC 28607

## OSI 85D V3.3 Guide

Contains fixes and other data OSI didn't tell you about. Increase compatibility between 65DV3.X and V3.3. Run extended utilities under V3.3 and more. \$14.95. New York residents add 7% sales tax.

Buffalo Informational Technologies  
209 Richmond Avenue  
Buffalo, NY 14222

## Software

For OSI C1P, C4P, and Commodore PET cassette-based systems. We have games and excellent graphics utilities. We are also looking for software for these systems. We pay excellent royalties. For a free catalog or more information, write to:

B.C. Software  
5152 Marcella Ave.  
Cypress, CA 90630

## Free Software

Join the *Big Red Apple Club*, a national Apple users' group with benefits including monthly newsletter and large library of free software. Annual membership \$12.00. Sample newsletter \$1.00.

Big Red Apple Club  
1301 N. 19th  
Norfolk, NE 68701  
(402) 379-3531

## Target-an AIM 65 Newsletter

Need information for your AIM 65 computer? News, software, and hardware are examples of items covered in the newsletter. Yearly subscription rates are \$7.00 in the US and Canada, \$12.00 elsewhere. Back issues are available beginning with 1979 at the same per year rate.

Target  
c/o Donald Clem  
RR#2  
Spencerville, OH 45887

## Double Precision Pascal

TeraComp — A scientific mathematics library for Apple Pascal. Gives the Apple mainframe accuracy with 64-bit double-precision mathematics. Package includes matrix operations including inverse, double-precision trigonometric functions, and dynamic array allocation. \$95.00 from:

PicoTera Systems  
P.O. Box 1631  
Corvallis, OR 97339  
(503) 754-0237

# APPLE Math Editor

by Robert D. Walker

**This Apple Pascal program allows for easy construction, editing, and printing of mathematical formulas.**

## Math Editor

requires:

Apple II with Pascal  
(optional: Dot-matrix printer  
such as Epson MX-80)

Anyone who has used a text editor for writing technical papers has encountered the problem of entering mathematical formulas into their text. If the formula is simple it may be typed into the text using the ASCII character set. More commonly, however, I find myself having to leave a blank area within the text and later writing the formula in with pencil. If you want a professional appearance this method is unacceptable. The following program, written in Apple Pascal, will solve this problem.

Although there is only one program here that does the formula editing, there are seven files used throughout this article. For this reason I recommend initializing a new disk, using "APPLE3: FORMATTER". Once this is done, change the volume name of this new disk from "BLANK:" to "MATH:" to make it easier to follow the article. It will also make the file names compatible with those included in the program listings.

## Creating the Math Character Set

The math character set includes a special cursor used by the Math Editor, the Greek alphabet, math symbols not included in the ASCII character set, and small digits used for subscripting and superscripting. In addition, there is room for two user-definable characters. These images (81 total) are stored in the textfile "MATH: MATHSET.TEXT" (see listing 1). This textfile will be used to create the datafile "MATH:

MATHSET. DATA", which contains these same images in a form readable by the Math Editor. (Ed. Note: Listing 1 has three full-size samples. Figure 1 has a dot matrix reduction of the characters. They should all be entered in "X" format.)

A few special rules must be followed when entering these images into the textfile. First, each image is an eight by eight dot matrix. Accordingly, each image occupies exactly eight lines of text, with each line having at least eight characters. Extra characters on each line are ignored and may be used for documentation. Second, the uppercase character "X" will show up as a white dot on the screen. All other characters will show up as black. Third, the first image of this textfile must be the special cursor. Fourth, there cannot be a linespace between images. Last, there must be 81 images (648 lines) in this textfile. Additional lines will be ignored.

Creating the math character datafile requires a small utility program [see listing 2, MATH: MATHCREATE.TEXT]. This program should be entered and compiled. When executed, this program (MATH: MATHCREATE.CODE) will read "MATH: MATHSET.TEXT" and create "MATH: MATHSET. DATA".

The major advantage of this storage method is that the textfile "MATH: MATHSET.TEXT" can easily be edited to suit the user's needs. Once this is done the datafile can be created by simply executing "MATH: MATHCREATE.CODE".

If you have followed all the steps up to this point then the following files should exist:

1. MATH:MATHSET.TEXT
2. MATH:MATHSET.DATA
3. MATH:CREATEMATH.TEXT
4. MATH:CREATEMATH.CODE

## Math Editor—Program Operation

The Math Editor program uses the TURTLEGRAPHICS library unit to display the formulas and messages on the high-resolution screen. The math formula is displayed on the upper half of the screen, while all messages are displayed on the lower half.

The program is entirely menu-driven and calls on nine main procedures. Once a procedure is called, simply hitting the return key will return the program to the main menu.

The "A[SCII]" command is used for putting text on the display. From the main program this procedure is called by typing "A". The user will then be prompted to enter the string. This

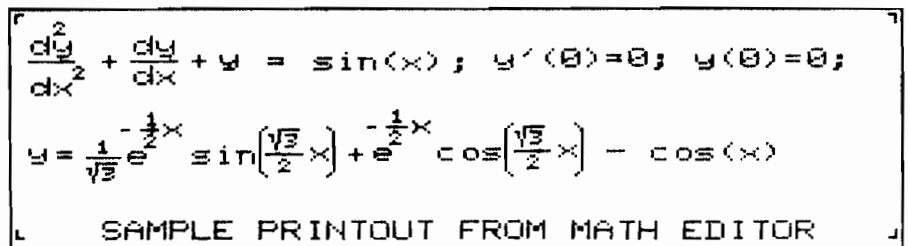

	A	B	C	D	E	F	G	H	I	J	K	L	M	N	O	P	Q	R	S	T
1	Δ	∇	∂	∂	∂	∂	∂	∂	∂	∂	∂	∂	∂	∂	∂	∂	∂	∂	∂	∂
2	∂	∂	∂	∂	∂	∂	∂	∂	∂	∂	∂	∂	∂	∂	∂	∂	∂	∂	∂	∂
3	∂	∂	∂	∂	∂	∂	∂	∂	∂	∂	∂	∂	∂	∂	∂	∂	∂	∂	∂	∂
4	∂	∂	∂	∂	∂	∂	∂	∂	∂	∂	∂	∂	∂	∂	∂	∂	∂	∂	∂	∂

Enter math character (ex. 1A):

**Listing 1: MATHSET.TEXT (Partial)**

```

...X.... (0) CURSOR
...X....
.....
XX...XX.
.....
...X....
...X....
.....
..XX.... (1) ALPHA
.X..X...
X....X..
XXXXXX..
X....X..
X....X..
X....X..
.....
XXXXXX.. (2) BETA
.X....X..
.X....X..
.XXXX...
.X....X..
.X....X..
XXXXXX..
.....

```

should be ended with a return character. The string will then be drawn in the lower left corner of the formula display area. Next, the moving menu will be displayed. The user will then use the keyboard for moving the string on the display.

The moving menu consists of six commands. "U)p", "D{own",

"L{eft", and "R{ight" move the string on the display. When these commands are first encountered they move the string ten dots on each keypress. The "S{mall movement" command is for small movement of the string. This command causes the string to be moved only one dot per keypress. Once the string is in the desired position, it is frozen by using the "F{reeze" command. This causes program control to return to the main menu.

The "M{athset" command is used to draw math characters on the display. When this command is invoked it displays the entire math character set in a table (see figure 1). The user selects the character by entering the row number followed by the column letter. Once this is done, the character will be displayed and moved as explained above.

Some characters, such as parentheses, brackets, and the integral sign must be drawn at different sizes. These characters are drawn as two halves. The "D{ots" command (described below) is then used to draw the midsection of these split characters.

The "D{ots" command allows the user to put dots on the screen. The user

first moves the cursor to the position where the first dot will be drawn and then freezes its position. The moving command is then used to determine where the next dot will be drawn. The "E{rase" command erases the last dot drawn. To exit this procedure simply hit the return key.

If a mistake is made while drawing a formula, then the "E{dit" command can be used to erase the most recently drawn character. For example, if the last operation was drawing a string on the display, then only the last character of the string will be erased. Likewise, if the last operation was drawing dots, then only the last dot drawn will be erased.

There are two commands used for loading and saving formulas on a "Math:" disk. First the "L{oad" command will clear the current display and load a previously stored formula. The "S{ave" command is used for saving the displayed formula. Both of these commands are written to avoid program interruption due to a disk I/O error.

Once a formula is constructed, the "P{rint" command is used to print a hardcopy of the display. The procedure

# OSI Disk Users

**Double your disk storage capacity  
Without adding disk drives**

Now you can more than double your usable floppy disk storage capacity—for a fraction of the cost of additional disk drives. Modular Systems' DiskDoubl<sup>er</sup>™ is a double-density adapter that doubles the storage capacity of each disk track. The DiskDoubl<sup>er</sup> plugs directly into an OSI disk interface board. No changes to hardware or software are required.

The DiskDoubl<sup>er</sup> increases total disk space under OS-65U to 550K; under OS-65D to 473K for 8-inch floppies, to 163K for mini-floppies. With the DiskDoubl<sup>er</sup>, each drive does the work of two. You can have more and larger programs, related files, and disk utilities on the same disk—for easier operation without constant disk changes.

Your OSI system is an investment in computing power. Get the full value from the disk hardware and software that you already own. Just write to us, and we'll send you the full story on the DiskDoubl<sup>er</sup>, along with the rest of our growing family of products for OSI disk systems.

™DiskDoubl<sup>er</sup> is a trademark of Modular Systems.

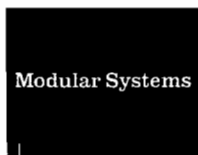

Post Office Box 16C  
Oradell, NJ 07649.0016  
Telephone 201 262.0093



better from inside out

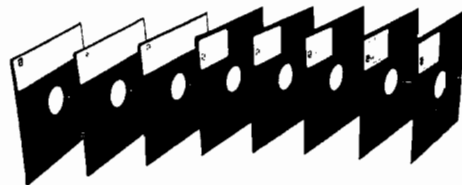

at the lowest price!

Call our Modem Hotline (anytime) - 619-268-4488 for exclusive monthly specials. Our free catalog contains more than 600 fantastic values.

**ABC Data Products**  
(formerly ABM)

8868 CLAIREMONT MESA BLVD.  
SAN DIEGO, CALIFORNIA 92123

ORDERS ONLY    ITT TELEX    INFORMATION  
800-850-1555    4992217    619-268-3537

"PRINT" was specifically written for the Epson MX-80 equipped with Graftrax. This procedure takes about 100 seconds to print the formula display area of the screen.

The "C[lear]" command is used to erase the current formula from the screen. This allows the user to start from scratch.

The "Q[uit]" command simply verifies that the user wants to quit the program.

### Conclusions

This program has the capacity for future expansion. For instance, an ambitious programmer might include a procedure for drawing variable size symbols such as parentheses and brackets. In addition, you might want to rewrite the editing procedure so that characters could be erased in any order. Both of these modifications increase the size of the program dramatically.

You may contact the author at 2850 Delk Rd., Apt. 2B, Marietta, GA 30067

### Listing 2: MATHCREATE.TEXT

```
(* $L PRINTER: *)

(*****)
(**)
(** This program creates the MATHSET.DATA file from the)
(** MATHSET.TEXT file. MATHSET.DATA file is used by MATH EDITOR.)
(**)
(*****)

PROGRAM CREATEMATHSETDATAFILE;

TYPE CHARARRAY=PACKED ARRAY[0..80,0..7,0..7] OF BOOLEAN;

VAR CHTEXT: TEXT;
    CHARRAY: CHARARRAY;
    CHDATA: FILE OF CHARARRAY;
    S: STRING;
    I,ROW,COLUMN: INTEGER;

BEGIN
  RESET(CHTEXT,'MATH:MATHSET.TEXT');
  REWRITE(CHDATA,'MATH:MATHSET.DATA');
  FOR I:=0 TO 80 DO (* read 81 image *)
    BEGIN
      WRITE(CHR(12)); (* clear screen *)
      FOR ROW:=7 DOWNT0 0 DO (* invert image *)
        BEGIN
          READLN(CHTEXT,S);
          WRITELN(S); (* echo image *)

          (* put image into character array *)
          (* 'X' is true, all other characters are false *)
          FOR COLUMN:=0 TO 7 DO CHARRAY[I,ROW,COLUMN]:=(S[COLUMN+1]='X')
        END
      END
    END
  END;
  CHDATA :=CHARRAY;
  PUT(CHDATA);
  CLOSE(CHDATA,LOCK)
END.
```

(Listing 3 begins on page 81)



**Use Color Power.**

ColorZAP uses the power of the Color Computer to provide both rapid scanning and full screen modification capabilities.

- Recover killed and clobbered files.
- Find unreadable disk sectors.
- Modify nibbles in hexadecimal.
- Copy sectors to same or different drive.
- Use color power to scan disk data.

Here's what the reviewers said...

About the program: "ColorZAP is a powerful program that allows you to see what is on the disk, modify it and, if possible, recreate it. Menu-driven, ColorZAP is extremely easy to use and well-documented...A good offering." — The RAINBOW, September 1982

About the manual: "A 24-page manual is included that describes program operation in detail. It also provides valuable information on the important disk system parameters." — MICRO, December 1982

For the TRS-80 Color Computer. Available on disk with an accompanying manual from **Software Options**, 19 Rector Street, New York, N.Y. 10006. 212-785-8285. **Toll-free order line: 800-224-1624.** Price: \$49.95 (plus \$2.00 per order shipping and handling). New York State residents add sales tax. Visa/Mastercard accepted.



## APPLE II PERIPHERAL DEVELOPERS:

Your complex function prototype requires the best wirewrap board available.

**SPECTRUM SYSTEMS . . . . . MAKES IT!**

### Fully Extended Wirewrap Protoboard.

Size: 2.8 by 10.7 inch 2 layer PC.  
Capacity: up to 58-16 pin or 12-40 pin or any combination sockets inbetween.

Carefully designed +5 and GND planes provide for the minimum electrical noise, low impedance, hi capacitance, and maximum versatility in the layout of IC's, capacitors, discretes and I/O connectors.

Wire-wrap technique documentation included.

Terms:

- \$45.00 + (6% Cal. Res. tax) + \$2.00 S&H.
- All payments must be in U.S. funds drawn on a U.S. bank.
- Outside U.S. add 10%.
- Cashier check/money order allow 30 day ARO.
- Personal checks add 2 weeks.
- No credit cards or cash, Please!

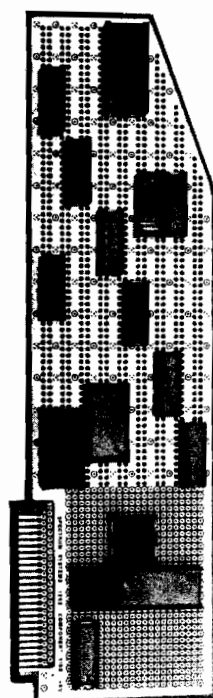

**Spectrum Systems**  
P.O. Box 2262  
Santa Barbara, Ca. 93120

Apple II is a trademark of Apple Computers.



**Listing 3: MATHED.TEXT**

```
(* $L PRINTER: *)
(* FIRST TEXTFILE - MATHEDI *)
(*****
**
** PROGRAM: MATH EDITOR
**
** AUTHOR: Robert D. Walker, Marietta, GA
**
** SUMMARY: This program uses the Apple high-resolution graphics for displaying and editing
** math formulas. Once the formula is generated it may be edited, saved, loaded, or
** printed. The printout procedure was specifically written for the Epson MX-80
** printer with Graftrax.
**
** HARDWARE: Apple II, Epson MX-80 printer with Graftrax
**
** LANGUAGE: Apple Pascal version 1.1
**
**
** $S+*)
PROGRAM MATHEDITOR;
USES TURTLEGRAPHICS;
CONST MAXDSP=1000; (* maximum no. of shapes drawn to screen *)
TYPE (* array of math characters *)
  CHARARRAY=PACKED ARRAY[0..80,0..7,0..7] OF
    BOOLEAN;
(* record of shapes displayed on screen *)
DSPRECORD=RECORD
  CHTYPE: (ASCII, MATHSET, DOT);
  CHCODE, XPOS, YPOS: INTEGER
  END;
VAR CHARARRAY: CHARARRAY;
    DSPARRAY: ARRAY[1..MAXDSP] OF DSPRECORD;
    LINENUM, NUMDSP: INTEGER;
    CH: CHAR;
    PIXEL: BOOLEAN;
PROCEDURE INIT; (* read math character file and initialize variables *)
VAR CHDATA: FILE OF CHARARRAY;
BEGIN
  INITTURTLE;
  MOVETO(96,150); WCHAR(chr(1));
  MOVETO(106,149); WSTRING('MATH EDITOR');
  RESET(CHDATA, 'MATH:MATHSET.DAT');
  CHARARRAY:=CHDATA
  INITTURTLE;
  VIEWPORT(0,279,102,191); FILLSCREEN(WHITE);
  VIEWPORT(1,278,103,190); FILLSCREEN(BLACK);
  CHATYPE(6);
  PIXEL:=TRUE;
  NUMDSP:=0
  END;
PROCEDURE DRAWSHAPE(I: INTEGER); (* (re)draw a single shape *)
BEGIN
  WITH DSPARRAY[I] DO
    CASE CHTYPE OF
```

**Listing 3 (continued)**

```
ASCII:
  BEGIN
    MOVETO(XPOS, YPOS);
    WCHAR(CHR(CHCODE));
  END;
(* draw math character *)
MATHSET: DRAWBLOCK(CHARRAY[CHCODE],
  2,0,0,8,8,XPOS,YPOS,6);
DOT:
  (* draw single dot *)
  DRAWBLOCK(PIXEL,
  1,0,0,1,1,XPOS,YPOS,10)
  END
PROCEDURE DRAWDISPLAY; (* redraw display with stored shapes *)
VAR DSPINDEX: INTEGER;
BEGIN
  VIEWPORT(1,278,103,190); (* erase display *)
  FILLSCREEN(BLACK);
  IF NUMDSP <> 0 THEN FOR DSPINDEX:=1 TO NUMDSP DO
    DRAWSHAPE(DSPINDEX);
  VIEWPORT(0,279,0,191)
  END;
PROCEDURE CLEARMESSAGE; (* clear message area of screen *)
BEGIN
  VIEWPORT(0,279,0,101); FILLSCREEN(BLACK);
  VIEWPORT(0,279,0,191);
  LINENUM:=90 (* This is top line where messages are written. *)
  END;
PROCEDURE WRITEMESSAGE(S: STRING); (* write message & update linenum *)
BEGIN
  MOVETO(0,LINENUM); WSTRING(S);
  LINENUM:=LINENUM-9;
  IF LINENUM < 0 THEN LINENUM:=0
  END;
PROCEDURE IOERROR(I: INTEGER); (* display disk I/O error *)
VAR CH: CHAR;
BEGIN
  CLEARMESSAGE;
  WRITEMESSAGE('I/O ERROR ');
  (* write I/O error number *)
  WCHAR(chr(((I DIV 10)+48)));
  WCHAR(chr(((I MOD 10)+48)));
  WRITEMESSAGE('');
  CASE I OF
    2: WRITEMESSAGE('BAD DEVICE NUMBER');
    3: WRITEMESSAGE('ILLEGAL OPERATION');
    5: WRITEMESSAGE('LOST DEVICE- NO LONGER ON LINE');
    6: WRITEMESSAGE('LOST FILE- NO LONGER IN DIRECTORY');
    7: WRITEMESSAGE('BAD TITLE- ILLEGAL FILENAME');
    8: WRITEMESSAGE('NO ROOM');
    9: WRITEMESSAGE('NO DEVICE- VOLUME NOT ON LINE');
    10: WRITEMESSAGE('NO SUCH FILE ON SPECIFIED VOLUME');
  END;
  WRITEMESSAGE('');
  WRITEMESSAGE('Hit <return> to continue....');
  READ(CH)
  END;
```



Listing 3 (continued)

```

PROCEDURE GETSTRING(VAR S: STRING); (* assemble & display string *)
VAR S1: STRING;
    S2: STRING[1];
    CH: CHAR;
BEGIN
    S1:='';
    S2:='';
    REPEAT
        READ(CH);
        IF CH IN [' ','z']
            THEN
                BEGIN
                    VCHAR(CH);
                    S2[1]:=CH;
                    S1:=CONCAT(S1,S2)
                END;
        IF CH=CHR(8) THEN IF LENGTH(S1) > 0
            THEN
                BEGIN
                    MOVETO(TURTLEX-7,TURTLEY);
                    WCHAR(S1[LENGTH(S1)]);
                    MOVETO(TURTLEX-7,TURTLEY);
                    S1:=COPY(S1,1,LENGTH(S1)-1)
                END
            UNTIL EOLN;
        S:=COPY(S1,1,LENGTH(S1)-1)
    END;
END;

```

```

PROCEDURE MOVINGMENU; (* display moving menu *)
BEGIN
    CLEARMESSAGE;
    WRITEMESSAGE('u(p)');
    WRITEMESSAGE('D(own)');
    WRITEMESSAGE('L(left)');
    WRITEMESSAGE('R(right)');
    WRITEMESSAGE('S(mall movement)');
    WRITEMESSAGE('F(freeze)');
    WRITEMESSAGE('');
    WRITEMESSAGE('< return > - EXIT Without Freeze')
END;

```

```

(* $MATHED2*)
(* SECOND TEXTFILE - MATHED2 *)
PROCEDURE DRAWASCII;
(***)
(** This is a main procedure which draws ASCII characters. *)
(***)
VAR I,INC,X,Y: INTEGER;
    S: STRING;
    CH: CHAR;
BEGIN
    CLEARMESSAGE;
    WRITEMESSAGE('Enter string:');
    VIEWPORT(1,278,103,190);
    X:=2; Y:=104; MOVETO(X,Y);
    GETSTRING(S);
    IF LENGTH(S)=0 THEN EXIT(DRAWASCII);
    MOVINGMENU;
    INC:=10;

```

Listing 3 (continued)

```

REPEAT
    READ(CH);
    MOVETO(X,Y);
    WSTRING(S);
    IF EOLN THEN EXIT(DRAWASCII);
CASE CH OF
    'u','u': Y:=Y+INC;
    'D','d': Y:=Y-INC;
    'L','l': X:=X-INC;
    'R','r': X:=X+INC;
    'S','s': INC:=1
END;
IF Y < 103 THEN Y:=103; (* an odd thing happens outside viewport *)
MOVETO(X,Y);
WSTRING(S)
UNTIL CH IN ['P','F'];

```

```

(* Store ASCII string in display array *)
FOR I:=1 TO LENGTH(S) DO
    BEGIN
        NUMDSP:=NUMDSP+1;
        WITH DSPARRAY[NUMDSP] DO
            BEGIN
                CHTYPE:=ASCII;
                CHCODE:=ORD(S[I]);
                XPOS:=(I-1)*7+X;
                YPOS:=Y
            END
        END
    END
END;

```

```

PROCEDURE DRAWMATHSET;
(***)
(** This is a main procedure which draws math characters. *)
(***)
(***)
VAR I,INC,MATHCODE,X,Y: INTEGER;
    CH: CHAR;
(* This procedure displays the selection of math characters. *)
PROCEDURE DISPLAYMATHSET;
BEGIN
    (* draw vertical lines *)
    FOR X:=0 TO 20 DO
        BEGIN
            PENCOLOR(NONE); MOVETO(X*11+28,41);
            PENCOLOR(WHITE); MOVETO(X*11+28,87)
        END;
    (* draw horizontal lines *)
    FOR Y:=0 TO 4 DO
        BEGIN
            PENCOLOR(NONE); MOVETO(26,Y*11+41);
            PENCOLOR(WHITE); MOVETO(246,Y*11+41)
        END;
    (* draw diagonal line *)
    PENCOLOR(NONE); MOVETO(28,85);
    PENCOLOR(WHITE); MOVETO(17,96);
    (* table *)
    PENCOLOR(NONE);

```

**Listing 3 (continued)**

```

FOR X:=0 TO 19 DO
  BEGIN
    MOVETO(X*11+30,87);
    WCHAR(CHR(X+65))
  END;
MOVETO(19,76); WCHAR('1');
MOVETO(19,65); WCHAR('2');
MOVETO(19,54); WCHAR('3');
MOVETO(19,43); WCHAR('4');
(* put mathset on screen *)
FOR I:=1 TO 80 DO
  BEGIN
    X:=((I-1) MOD 20)*11+30;
    Y:=(3-((I-1) DIV 20))*11+43;
    DRAWBLOCK(CHARRAY[I],2,0,0,8,8,X,Y,6)
  END
END; (* DISPLAYMATHSET *)

BEGIN (* DRAWMATHSET *)
  CLEARMESSAGE;
  DISPLAYMATHSET;
  LINENUM:=21;
  WRITEMESSAGE('Enter math character (ex. 1A): ');
  (* Get two valid characters from user *)
  (* A < return > character will cause an exit from DRAWMATHSET *)
  REPEAT READ(CH) UNTIL (CH IN ['1'..'4']) OR EOLN;
  IF CH=' ' THEN EXIT(DRAWMATHSET);
  WCHAR(CH);
  MATHCODE:=(ORD(CH)-49)*20;
  REPEAT READ(CH) UNTIL (CH IN ['A'..'T','e'..'t']) OR EOLN;
  IF CH=' ' THEN EXIT(DRAWMATHSET);
  WCHAR(CH);
  (* Draw math character and move it. *)
  MOVINGMENU;
  VIEWPORT(1,278,103,190);
  X:=2; Y:=104; INC:=10;
  DRAWBLOCK(CHARRAY[MATHCODE],2,0,0,8,8,X,Y,6);
  REPEAT
    READ(CH);
    DRAWBLOCK(CHARRAY[MATHCODE],2,0,0,8,8,X,Y,6);
    IF EOLN THEN EXIT(DRAWMATHSET);
  CASE CH OF
    'U','u': Y:=Y+INC;
    'D','d': Y:=Y-INC;
    'L','l': X:=X-INC;
    'R','r': X:=X+INC;
    'S','s': INC:=1
  END;
  IF Y<103 THEN Y:=103;
  DRAWBLOCK(CHARRAY[MATHCODE],2,0,0,8,8,X,Y,6)
  UNTIL CH IN ['F','f'];
  (* Store math character in display array *)
  NUMDSP:=NUMDSP+1;
  WITH DSPARRAY[NUMDSP] DO
    BEGIN
      CHTYPE:=MATHSET;
      CHTYPE:=MATHCODE;

```

**Listing 3 (continued)**

```

XPOS:=X;
YPOS:=Y
END

END; (* DRAWMATHSET *)
PROCEDURE DRAWDOTS;
  (** This is a main procedure which draws dots. **)
  (** ***** **)
  VAR INC,STARTNUM,X,Y: INTEGER;
  CH: CHAR;
  BEGIN
    (* move cursor *)
    MOVINGMENU;
    X:=2; Y:=104; INC:=10;
    DRAWBLOCK(CHARRAY[0],2,0,0,8,8,X,Y,6);
    REPEAT
      READ(CH);
      DRAWBLOCK(CHARRAY[0],2,0,0,8,8,X,Y,6);
      IF EOLN THEN EXIT(DRAWDOTS);
    CASE CH OF
      'U','u': Y:=Y+INC;
      'D','d': Y:=Y-INC;
      'L','l': X:=X-INC;
      'R','r': X:=X+INC;
      'S','s': INC:=1
    END;
    DRAWBLOCK(CHARRAY[0],2,0,0,8,8,X,Y,6)
    UNTIL CH IN ['F','f'];
    DRAWBLOCK(CHARRAY[0],2,0,0,8,8,X,Y,6);
  (* draw dots *)
  X:=X+3; Y:=Y+4;
  CLEARMESSAGE;
  WRITEMESSAGE('U(put)');
  WRITEMESSAGE('D(own)');
  WRITEMESSAGE('L(left)');
  WRITEMESSAGE('R(right)');
  WRITEMESSAGE('E(rase)');
  WRITEMESSAGE(' ');
  STARTNUM:=NUMDSP;
  DRAWBLOCK(PIXEL,1,0,0,1,1,X,Y,10);
  NUMDSP:=NUMDSP+1;
  WITH DSPARRAY[NUMDSP] DO
    BEGIN
      CHTYPE:=DOT;
      XPOS:=X;
      YPOS:=Y
    END;
  REPEAT
    READ(CH);
  CASE CH OF
    'U','u': Y:=Y+1;
    'D','d': Y:=Y-1;
    'L','l': X:=X-1;
    'R','r': X:=X+1;
    'E','e': IF (NUMDSP>STARTNUM) (* erase dot *)
      THEN
        BEGIN
          PIXEL:=FALSE;
          DRAWBLOCK(PIXEL,1,0,0,1,1,X,Y,10);

```

Listing 3 (continued)

```

NUMDSP:=NUMDSP-1;
X:=DSPARRAY[ NUMDSP ].XPOS;
Y:=DSPARRAY[ NUMDSP ].YPOS;
PIXEL:=TRUE
END;

END;
IF CH IN ['U','u','D','d','L','l','R','r']
THEN
BEGIN
DRAWBLOCK(PIXEL,1,0,0,1,1,X,Y,10);
NUMDSP:=NUMDSP+1;
WITH DSPARRAY[ NUMDSP ] DO
BEGIN
CHTYPE:=DOT;
XPOS:=X;
YPOS:=Y
END
END
UNTIL EOLN
END;

```

```

PROCEDURE EDIT;
(*****
**)
(** This is a main procedure which edits the display array by
(** by deleting the last stored shape.
**)
(*****
**)
VAR CH: CHAR;
BEGIN
CLEARMESSAGE;
WRITEMESSAGE('E(erase)');
WRITEMESSAGE(' ');
REPEAT
WRITEMESSAGE('<return> - EXIT');
IF NUMDSP=0 THEN EXIT(EDIT);
READ(CH);
IF CH IN ['E','e']
THEN
BEGIN
NUMDSP:=NUMDSP-1;
(** erase shape *)
PIXEL:=FALSE;
DRAWSHAPE(NUMDSP+1);
PIXEL:=TRUE
END
UNTIL EOLN;
END;
(***I-*)
PROCEDURE LOAD;
(*****
**)
(** This is a main procedure which loads a previously saved display.
**)
(*****
**)
VAR DSPFILE: FILE OF DSPRECORD;
S: STRING;
I: INTEGER;
BEGIN
CLEARMESSAGE;

```

Listing 3 (continued)

```

GETSTRING(S);
IF LENGTH(S)=0 THEN EXIT(LOAD);
S:=CONCAT('MATH:',S,'DSP');
RESET(DSPFILE,S);
I:=IORESULTS;
IF I < > 0
THEN
BEGIN
IOERROR(I);
EXIT(LOAD)
END
ELSE (* Load DSPARRAY *)
BEGIN
NUMDSP:=0;
WHILE NOT EOF(DSPFILE) DO
BEGIN
NUMDSP:=NUMDSP+1;
DSPARRAY[ NUMDSP ]:=DSPFILE ^;
GET(DSPFILE);
I:=IORESULTS;
IF I < > 0
THEN
BEGIN
IOERROR(I);
EXIT(LOAD)
END
END
END;

PROCEDURE SAVE;
(*****
**)
(** This is a main procedure which saves the current display.
**)
(*****
**)
VAR DSPFILE: FILE OF DSPRECORD;
S: STRING;
DSPINDEX,I: INTEGER;
BEGIN
IF NUMDSP=0 THEN EXIT(SAVE); (* don't save empty display *)
CLEARMESSAGE;
WRITEMESSAGE('Enter File Name: ');
GETSTRING(S);
IF LENGTH(S)=0 THEN EXIT(SAVE);
S:=CONCAT('MATH:',S,'DSP');
REWRITE(DSPFILE,S);
I:=IORESULTS;
IF I < > 0
THEN
BEGIN
IOERROR(I);
EXIT(SAVE)
END
ELSE (* save DSPARRAY *)
BEGIN
FOR DSPINDEX:=1 TO NUMDSP DO
BEGIN
DSPFILE ^ =DSPARRAY[ DSPINDEX ];
PUT(DSPFILE);
I:=IORESULTS;
IF I < > 0
THEN

```

Listing 3

```

BEGIN
  IOERROR(I);
  EXIT(SAVE)
END
END;
CLOSE(DSPFILE, LOCK)
END;
I:=IORESULTS;
IF I < > 0 THEN IOERROR(I)
END;
(**I**)

(**R**) (* speed up this procedure *)
PROCEDURE PRINT;
*****
(** This is a main procedure which prints the display. This
(** procedure is written for the EPSON MX-80 with GRAFTRAX.
*****
(**
(** TYPE BYTE=0..255;
(** use variant record to associate printing wires w/byte *)
WIRES=PACKED RECORD CASE BOOLEAN OF
  TRUE: (BO: PACKED ARRAY[0..7] OF BOOLEAN);
  FALSE: (BY: BYTE)
END;

VAR I,X,Y,YINC: INTEGER;
A: PACKED ARRAY[1..278] OF BYTE;
S: PACKED ARRAY[1..4] OF BYTE;
W: WIRES;
CH: CHAR;
P: INTERACTIVE;
BEGIN
  CLEARMESSAGE;
  WRITEMESSAGE('Print screen (Y/N)? ');
  READ(CH);
  IF NOT (CH IN ['Y','y']) THEN EXIT(PRINT);
  CLEARMESSAGE;
  WRITEMESSAGE('Printing screen...');
  REWRITE(P, 'PRINTER: ');

  (* set line spacing 24/216 *)
  S[1]:=27; S[2]:=51; S[3]:=24;
  UNITWRITE(6,S[1],3,0,12);

  (* print screen *)
  FOR I:=10 DOWNTO 0 DO
  BEGIN
    WRITE(P, ' ', I); (* center printout *)
    S[1]:=27; S[2]:=75; S[3]:=22; S[4]:=1;
    UNITWRITE(6,S[1],4,0,12);
    FOR X:=1 TO 278 DO
      BEGIN
        FOR YINC:=0 TO 7 DO
          W.BO[YINC]:=SCREENBIT(X, (I*8)+103+YINC);
          A[X]:=-W.BY
        END;
        UNITWRITE(6,A[1],278,0,12);
        WRITELN(P)
      END;
    END.
  END.

```

Listing 3 (continued)

```

S[1]:=27; S[2]:=64;
UNITWRITE(6,S[1],2,0,12)
END;
(**R**)

PROCEDURE CLEAR;
*****
(** This is a main procedure which clears the display.
*****
(**
(** VAR CH: CHAR;
BEGIN
  CLEARMESSAGE;
  WRITEMESSAGE('Clear screen (Y/N)? ');
  READ(CH);
  IF CH IN ['Y','y'] THEN NUMDSP:=0
END;

PROCEDURE QUIT;
*****
(** This is a main procedure which checks if the user wants to quit.
*****
(**
(** VAR CH1: CHAR;
BEGIN
  CLEARMESSAGE;
  WRITEMESSAGE('Quit (Y/N)? ');
  READ(CH1);
  IF NOT(CH1 IN ['Y','y']) THEN CH:=' '
END;

BEGIN (* MATHEDITOR - main program *)
  INIT;
  REPEAT
    DRAWDISPLAY;
    CLEARMESSAGE;
    WRITEMESSAGE('A(SCII)');
    WRITEMESSAGE('M(athset)');
    WRITEMESSAGE('D(rav)');
    WRITEMESSAGE('E(dit)');
    WRITEMESSAGE('L(oad)');
    WRITEMESSAGE('S(ave)');
    WRITEMESSAGE('P(rint)');
    WRITEMESSAGE('C(lear)');
    WRITEMESSAGE('Q(uit)');
    WRITEMESSAGE(' ');
    WRITEMESSAGE('Enter command: ');
    REPEAT READ(CH) UNTIL CH IN ['A','a','M','m','D','d','E','e','L','l',' '];
  CASE CH OF
    'A','a': DRAWASCII;
    'M','m': DRAWMATHSET;
    'D','d': DRAWDOTS;
    'E','e': EDIT;
    'L','l': LOAD;
    'S','s': SAVE;
    'P','p': PRINT;
    'C','c': CLEAR;
    'Q','q': QUIT
  END
  UNTIL CH IN ['Q','q'];
  WRITE(CHR(12))
END.

```

# Using Long Integers for BCD Numbers in Pascal

by David C. Oshel

---

**This article presents a bullet-proof string conversion for Pascal 1.1 long integers with implied decimal points.**

---

**BCDNUMS Demo**  
requires:  
Pascal

---

English is an unimplemented programming language because it has no compiler; in some respects, Pascal belongs in the same category. While Pascal is a strong "top-down" programming language, some of its versions are particularly weak as "top-to-bottom" practical tools. Unlike extremely practical languages like FORTRAN and COBOL, Pascal has left a number of design decisions undecided, perhaps because few people have found uses for Pascal when other languages are available.

In the microcomputer field, however, Pascal's strengths outweigh some of its weaknesses, and it is virtually the only choice when program reliability and size are significant design criteria (with the possible exceptions of FORTH and Microsoft FORTRAN.) There is no question that Pascal is influential; the recent appearance of structured FORTRAN, or "FORTRAN77," is sufficient proof that concepts embodied in Pascal are worth learning well.

Pascal's worst failing is its inability to read numerical data efficiently. This article presents one method for interpreting Long Integers as accurate bcd numbers with decimal points. The difference between a Long Integer and a bcd number is usually that the bcd number has an implied decimal point; the Long Integer (its internal structure is not as interesting as its uses), can be interpreted several ways.

Long Integers can be used to represent dollar-and-cents amounts. All dollar amounts are represented as multiples of 100 cents, and the decimal point is understood to be two places in from the right. If you are working with millage rates or titrations, then you may understand the decimal point to be three, four, or five places in from the right, provided the bcd number is properly normalized. By using bcd numbers, complemented with appropriate special algorithms for multiplication and division, you may avoid the rounding errors that are sometimes the bane of ordinary floating-point variables. The price you pay is twofold: first, bcd numbers have a large overhead in terms of memory and disk space. Second, the Pascal interface to bcd numbers is an exponential function of aggravation.

Two procedures are outlined in this article. The first, a function called BCDVAL, scans an input string, converts it to a bcd number, and returns the boolean value TRUE if conversion was successful. The second procedure, called STRBCD, provides the inverse utility by converting a bcd number to an ASCII string. You may also select whether to affix the minus sign ahead of or behind the number, consistent with business practice.

The normalization constant "Right-size" is actually a variable, as used here. It is global to both BCDVAL and STRBCD. Note one subtle point: all bcd numbers entered with a particular Rightsize are actually *typed* variables, but the Pascal operating system will have no inkling of the fact because all it sees are Long Integers. If you wish to inform Pascal that you are working with typed variables, you should declare a Record type, which maintains the bcd variable and its associated implied decimal point together. If program logic allows, you may still

avoid the Record type (and attendant overhead) by normalizing short numbers "on the fly" to the longest required Rightsize before you attempt arithmetic on the variables. In most applications, neither maneuver will be necessary because most applications do not mix types. If you select Rightsize = 2, then you are working with dollars and cents.

The BCDVAL function protects itself from abnormal input and is safe to use with READLN. In other words, your program will not crash if BCDVAL encounters non-numeric characters, duplicate decimal points, etc. If the input is likely to cause a Long Integer range error, which can have dangerously unpredictable side-effects on the operating system, then BCDVAL takes its normal error exit and returns FALSE, along with the formal parameter BCD=0. In the interest of program brevity there is no indication of what actually caused the error.

There is also a possibility that some valid inputs will take the overflow exit; this occurs when the length of the input, plus the variable Rightsize, exceeds the Long Integer parameter Maxlint (i.e., TYPE Lint = Integer [Maxlint].) You may avoid the problem either by declaring a larger Maxlint (and then re-compiling), or by writing a more intelligent overflow trap. The trap provided is conservative, and will correctly flag *all* overflow errors, plus a few of the *almost* cases. In Apple Pascal, Maxlint may range as high as 36; refer to the *Pascal Language Reference Manual* for details.

---

David Oshel works as a consultant designing small information management systems for Democratic political candidates. You may contact him at 1219 Harding Ave., Ames, IA 50010.

---

### Listing 1: BCDNUMS Demo

```

Program Bcdnums-Demo;
{ * Demonstrating the use of Apple Pascal 1.1 Long Integers as
  * Binary-coded-decimal numbers with implied decimal points.
  *
  * David C. Oshel
  * 1219 Harding Ave.
  * Ames, Iowa 50010 --- March 17, 1982 }
CONST Maxlint = 16; { Occupies 10 bytes }
      NULL = ''; { Concatenation constants }
      SPACE = ' ';
      ZERO = '0';
      RADIX = '.'; { Decimal point char in Bcdnums }
      MINUSIGN = '-';
TYPE Charset = Set of Char;
      Bodnum = Integer[Maxlint]; { BCDVAL normalizes these to Rightsize }
VAR Rightsize: Integer; { Number of dec places in Bodnums; default = 2 }
    { Demo program variables follow }
    P,Q : Bodnum;
    S : String;
    Loop : Integer;
    Num,Minusloc : Boolean;
Function BCDVAL(VAR Numstr:String; VAR Bod:Bodnum):Boolean;
{ All BCDVAL's are normalized; e.g., Dollar values ($0.00 are
  represented internally as multiples of 100cents. Normalization
  is then a simple function of Rightsize, as is radix insertion...
  The default is Rightsize=2, for Dollars-and-cents; note that input
  range errors when working with Long Integers cause a fatal SYSTEM
  crash...! }
VAR I,J,K,Len : Integer;
    Got-radix,Minus : Boolean;
    Numeric : Charset;
    Temp : String;
    T1 : String[1];
Procedure Valerr; {Overflow, or near enough to...}
Begin
  Write(chr(7));
  Exit(Bodval) {Conditions on Exit: Bodval=False, Bod=0}
End; { Valerr }
Procedure Truncate;
Begin
  { Truncate extra digits right of radix... }
  J := Pos(Radix,Temp);
  If J <> 0 then
    Begin
      If (Length(Temp) - J + 1) > Rightsize then
        Temp:=Copy(Temp,1,J+Rightsize)
      End
    End; { Truncate }
Procedure Goodstring;
{ Shift all chars that belong in legal Bod numbers
  into a temporary string accumulator & chop the remainder.. }
VAR Okset : Charset;
Begin { Goodstring }
  Okset := Numeric + ['+', '-', Radix]; { Ignore $, commas, etc. }
  For I := 1 to Len do
    Begin
      If Numstr[I] in Okset then
        Begin
          If Numstr[I] in ['+', '-'] then
            Begin
              Okset := Okset - ['+', '-'];
              If Numstr[I] = '-' then Minus := True
            End
          Else If Numstr[I] in Numeric + [Radix] then
            Begin
              If Numstr[I] = Radix then Okset := Okset - [Radix];
              T1[1] := Numstr[I];
              Temp := Concat(Temp,T1)
            End
          End
        End
      End
    End; { Goodstring }
Procedure Normalize;
Begin
  While J < Rightsize do
    Begin
      Bod := Bod * 10;
      J := J + 1
    End
  End; { Normalize }
Begin { Bodval }
  BCDVAL := False;
  Numeric := ['0'..'9'];
  T1 := SPACE;
  Temp := NULL;

```

### BCDNUMS Demo (continued)

```

Bod:=0; Len := Length(Numstr); Minus := False; Got-radix := False;
If Len = 0 then Exit(Bodval);
If (Rightsize < 0) or (Rightsize > Maxlint) then Rightsize:=0;
Goodstring; { Zap spaces, $$, commas, any extra garbage }
If Length(Temp)+Rightsize >= Maxlint then Valerr;
Truncate; { Drop extra digits on the right }
Len := Length(Temp); { New length... }
If (Len = 0) or (Temp = Radix) then Exit(BCDVAL); { Non-numeric input }
J := 0;
For I := 1 to Len do
  Begin
    If Temp[I] = Radix then Got-radix := True
    Else If Temp[I] in Numeric then
      Begin
        Bod := (Bod*10) + (Ord(Temp[I]) - Ord('0'));
        If Got-radix then J:=J+1 { Count decimal places }
      End
    End;
  End;
  Normalize;
  If Minus then Bod := -Bod;
  BCDVAL := True
End; { Bodval }
Procedure STRBCD(VAR S:String; Bod:Bodnum; Suffixsign:Boolean);
{ DO the opposite of BCDVAL, i.e., convert a bodnum to an ASCII string;
  If Suffixsign is True, then affix the Minus Sign, if required, to
  the end of the string, as in 100.00-}
VAR I : Integer;
    Stemp : String;
    Sfix : String[1];
Procedure Padleft;
Begin
  Stemp:=NULL;
  For I := Length(S) to Rightsize do Stemp:=Concat(Stemp,ZERO);
  S:=Concat(Stemp,S)
End;
Begin
  If (Rightsize > Maxlint) or (Rightsize < 0) then
    Rightsize:=0
  Sfix := SPACE;
  Str(Bod,S);
  If Bod < 0 then
    Begin
      Delete(S,1,1); { Drop minus sign }
      Sfix := MINUSIGN
    End;
  If Length(S) <= Rightsize then Padleft; { Do 0.ZZZZ Format }
  Insert(Radix,S,Length(S)-Rightsize+1);
  If Suffixsign then S:=Concat(S,Sfix) else S:=Concat(Sfix,S)
End; { Strbcd }
BEGIN { Main }
Rightsize := 2; { Must be declared in Initialization part of a Unit }
{ DEMO CODE }
Page(Output);
Writeln('Demonstration of BCD numbers in Pascal');
For Loop := 0 to 5 do
  Begin
    Rightsize := Loop; { Range errors are checked by Bodval }
    Minusloc := ODD(Loop); { Decide Minus sign loc: True = Suffix }
    Q := 0; { Summation accumulator }
    Repeat
      Writeln;
      Write('Input a number['',Rightsize,'] -> ');
      Readln(S);
      Num := Bodval(S,P);
      If Num then
        Begin
          Q:=Q+P;
          Strbcd(S,P,Minusloc);
          Writeln(S:26);
          Writeln
        End
      End
    until not Num;
    Strbcd(S,Q,Minusloc);
    Writeln;Writeln('Sum = ',S:20);Writeln
  End; { Loop }
Writeln;Write('That's all Folks...')
END. { Main }

```



# NEW FROM D & N MICRO PRODUCTS, INC.

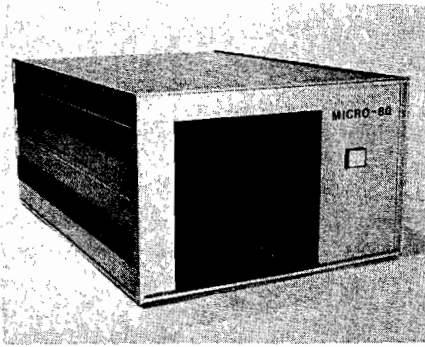

## MICRO-80 COMPUTER

Z80A CPU with 4MHz clock and CP/M 2.2 operating system. 64K of low power static RAM. Calendar real time clock. Centronics type parallel printer interface. Serial interface for terminal communications, dip switch baud rates of 150 to 9600. 4" cooling fan with air intake on back of computer and discharge through ventilation in the bottom. No holes on computer top or side for entry of foreign object. Two 8" single or double sided floppy disk drives. IBM single density 3740 format for 243K of storage on each drive. Using double density with 1K sectors 608K of storage is available on a single sided drive or 1.2 meg on a double sided drive. Satin finish extruded

aluminum with vinyl woodgrain decorative finish. 8 slot backplane for expansion. 48 pin buss is compatible with most OSI boards. Uses all standard IBM format CP/M software.

Model 80-1200	\$2995
2 8" single sided drives, 1.2 meg of storage	
Model 80-2400	\$3495
2 8" double sided drives, 2.4 meg of storage	
Option 001	\$ 95
Serial printer port, dip switch baud rate settings	

### Software available in IBM single density 8" format.

<b>Microsoft</b>		<b>Digital Research</b>		<b>Micropro</b>	
Basic-80	\$289	PL/1-80	\$459	Wordstar	\$299
Basic Compiler	\$329	Mac	\$ 85	Mail-Merge	\$109
Fortran-80	\$410	Sid	\$ 78	Spellstar	\$175
Cobol-80	\$574	Z-Sid	\$ 95	SuperSort I	\$195
Macro-80	\$175	C Basic-2	\$110	<b>Pascal</b>	
Edit-80	\$105	Tex	\$ 90	Pascal/MT +	\$429
MuSimp/Mu Math	\$224	DeSpool	\$ 50	Pascal Z	\$349
MuLisp-80	\$174	<b>Ashton-Tate</b>		Pascal M	\$355
		dBase II	\$595		

## Convert almost any static memory OSI machine to CP/M® with the D & N-80 CPU Board.

Z80A CPU with 4MHz clock. 2716 EPROM with monitor and bootstrap loader. RS-232 serial interface for terminal communications or use as a serial printer interface in a VIDEO system. Disk controller is an Intel 8272 chip to provide single or double density disk format. 243K single density or 608K double density of disk storage on a single sided 8" drive. A double sided drive provides 1.2 meg of storage. DMA used with disk controller to unload CPU during block transfers from the disk drives. Optional Centronics type parallel printer port com-

plete with 10 ft. cable. Optional Real Time Calendar Clock may be set or read using 'CALL' function in high level languages. Power requirements are only 5 volts at 1.4 amps. Available with WORDSTAR for serial terminal systems.

### INCLUDES CPM 2.2

D & N-80 serial	\$695
D & N-80 serial w/Wordstar	\$870
D & N-80 video	\$695
Option 001	\$ 80
parallel printer and real time calendar clock	

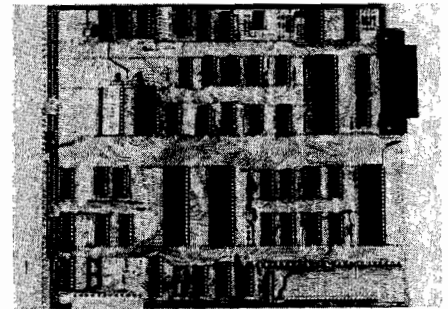

## D & N-80 CPU BOARD

## OTHER OSI COMPATIBLE HARDWARE

**IO-CA10X Serial Printer Port** \$125  
Compatible with OS-85U and OS-85D software

**IO-CA9 Parallel Printer Port** \$175  
Centronics standard parallel printer interface with 10 ft. flat cable

**BP-580 8 Slot Backplane** \$ 47  
Assembled 8 slot backplane for OSI 48 pin buss

**24MEM-CM9 \$380**    **24MEM-CM9F \$530**  
**16MEM-CM9 \$300**    **16MEM-CM9F \$450**  
**8MEM-CM9 \$210**    **8MEM-CM9F \$360**  
**BMEM-CM9F \$ 50**    **FL470 \$180**  
24K memory/floppy controller card supports up to 24K of 2114 memory chips and an OSI type floppy disk controller. Available fully assembled and tested with 8, 16, or 24K of memory, with floppy controller (F). Controller supports 2 drives. Needs separated clock and data inputs. Available Bare (BMEM-CM9F) or controller only (FL-470). Ideal way to upgrade cassette based system

**C1P-EXP Expansion Interface** \$ 65  
Expansion for C1P 600 or 610 board to the OSI 48 pin buss. Requires one slot in backplane. Use with BP-580 backplane

**BIO-1600 Bare IO card** \$ 50  
Supports 8K of memory, 2 16 bit parallel ports may be used as printer interfaces. 5 RS-232 serial ports, with manual and Molex connectors

**DSK-SW Disk Switch** \$ 29  
Extends life of drive and media. Shuts off minifloppy spindle motor when system is not accessing the drive. Complete KIT and manual

### Disk Drives and Cables

**8" Shugart SA801** single sided \$395  
**8" Shugart SA851** double sided \$585  
**FLC-6** 6ft. cable from D & N or OSI controller to 8" disk drive \$ 69  
**5 1/4" MPI B51** with cable, power supply and cabinet \$450  
**FLC-5 1/4** 8 ft. cable for connection to 5 1/4 drive and D & N or OSI controller, with data separator and disk switch \$ 75

**Okidata Microline Printers**

**ML 82A Dot Matrix Printer** \$534  
120 CPS, 80/120 columns, 9.5" paper width friction or pin feed

**ML 83A** Same as 82A except \$89!  
16" paper width, 132/232 columns with tractor feed

**ML 84** Same as 82A except 200 CPS, \$115:  
16" paper width, 132/232 columns, 2K buf fer, dot addressable graphics, with tractor feed

## D & N Micro Products, Inc.

3684 N. Wells St.  
Fort Wayne, Ind. 46808  
(219) 485-6414



TERMS \$2.50 shipping, Foreign orders add 15%.  
Indiana residents add 4% sales tax.

## PET BASIC to Waterloo Basic

Jerry D. Bailey, 9642 Remer, So El Monte, CA, 91733

As discussed in the October, 1982 PET Vet, Waterloo BASIC offers much more sophisticated program control structures than PET BASIC. Also, PET BASIC and Waterloo BASIC have different ways of implementing certain structures and functions. You'll need to do light to moderate editing including inserting blanks after key words when necessary.

There are several points you must consider when converting PET BASIC program files to Waterloo BASIC-readable program files:

1. The program file must be converted to a sequential file.
2. Line numbers must be forced to five characters with leading blanks.
3. Alphabetic characters must be converted to lower-case ASCII.

Use the following line in direct mode to convert a program in memory to PET ASCII. (Be sure the program does not start with line 0, since Waterloo BASIC will not accept a line 0.)

```
dopen#8, "FILENAME",w:cmd8:list
```

When the cursor returns, enter:

```
dclose:xx
```

This will give a syntax error, but the file will be closed and the cursor will return properly. Now you can use the following program to format the file for access by Waterloo BASIC's OLD command.

Be sure to substitute the appropriate names in lines 10 and 30. The two GET#8's in line 20 discard the carriage returns that CMD puts at the front of the file. Line 40 checks for the "r" in "ready", which marks the last line in the file. All other lines will begin with a space. Line 50 converts the alphabetic characters to true ASCII lower case.

Line 60 builds the output string and checks for the end-of-line carriage return. Line 70 searches for the space following the line number. Line 80 pads the line so that the line number always occupies the first five spaces, padded with leading blanks, and writes the line to the output file. Line 90 goes back for the next program line.

This is not a particularly friendly program, in that it simply stops on errors and requires the file names to be written into the program. But it will get the job done. After the file is up in Waterloo BASIC, it will probably not run right away. You'll need to do light to moderate editing.

## Numerical Rounding

Chuck Muhleman, Computer-ease, Box 806, Marion, IN 46952

You may calculate numbers properly using all possible digits internal to a computer or calculator. You should *not* state the answer with all the digits shown. The accuracy of any answer is only as good as the accuracy of the least accurate input to the problem. Thus, when the calculation is completed, the answer usually must be rounded to show the proper accuracy. I say "usually" because some calculations give exact values:  $2*3$ , or  $2.33*3 = 6.99$ .

When you do a series of calculations involving several formulae, the answer

should be rounded. For financial problems, such as computing an amortization table, the answer should be rounded to the nearest cent. For instance, in an amortization computation the interest due for a specific month is computed, rounded to the nearest cent, subtracted from the monthly payment, and the balance applied to the principal. After all, you do not normally make payments less than \$0.01 each, and the loan repayment must be larger than the interest due or the loan will never be repaid.

Remember that answers do not need to involve fractions for rounding to apply. For example, when considering the populations of cities rounded to the nearest 1000, it would be improper to give an answer such as 53 162, say, for a population average of all the cities within a state. The proper answer would be 53 000. (Note that numbers over four digits on either side of the decimal are separated by spaces, not commas. This is now preferred in deference to the European practice of using commas where Americans use decimal points.)

Do not use algorithms which just truncate the answer; i.e., drop the unwanted fractional parts. Why use a sophisticated computer, then give an answer similar to that of an elementary school student?

Another important point to remember is when the fractional part is exactly equal to 0.5, then the answer should be rounded to the nearest *even* number. That is, 3.15 should be rounded to 3.2, as should be 3.25. (continued)

### Bailey — Conversion Routine

```
10 DOPEN#8, "TEST" ; IFDSTHENPRINTDS# ; STOP
20 N$=CHR$(0) ; GET#8, A# ; GET#8, A#
30 DOPEN#9, "WATTEST", W ; IFDSTHENPRINTDS# ; STOP
40 B$="" ; GET#8, A# ; IFA$="R" THENDCLOSE ; END
50 GET#8, A# ; PRINTA# ; A=ASC(A#+N#) ; IFA>64 AND A<91 THENA=A+32
60 B$=B#+CHR$(A) ; IFA-13GOTO50
70 FORI=2TOLEN(B#) ; IFMID$(B#, I, 1)<>" " THENNEXTI ; STOP
80 PRINT#9, LEFT$( "      ", 6-I)B# ; IFDSTHENPRINTDS# ; STOP
90 GOTO40
```

## Short Subjects *(continued)*

The common way to round is to convert the number to an integer using logarithms, round, then find the antilog to get an answer. This method is fine, except the manipulation must be different for numbers less than or greater than 1. Also, the math algorithms internal to a computer may give some strange answers because they manipulate using binary numbers, not decimals.

The accompanying algorithm, in BASIC, will round numbers input as variable N1 to the number of significant figures input as variable M1. This algorithm also rounds the fraction 0.5 properly.

To handle the strange answers caused by the binary numbers, string functions may be employed when the magnitude of the answer is known. This is generally true for a given problem, such as an amortization table or a table of wire resistance. Other useful math subroutines and algorithms are included in the program listing.

```

10 REM "MATH" C&J Supply 7/5/81 Bytes=3298
11 REM Remember this system computes to 9 sig. figures
12 DEF FNDC(X) = INT((X + .0001) * 100) :
    REM Stop $ RD Error; '/100' for answer
13 E0 = 2.7122813
14 DEF FNLG(X) = LOG(X)/LOG(10) : REM LN to LOG
15 DEF FNNS(X) = ATN(X /SQR(1-X^2)) : REM ARCSIN
16 DEF FNCS(X) = (PI/2)-FNNS(X) : REM ARCCOS
17 DEF FNHP(X) = (E0^X-E0^(-X))/2 : REM SINH
18 DEF FNJP(X) = (E0^X+E0^(-X))/2 : REM COSH
19 DEF FNTC(X) = (X-32)*5/9 : REM Farenheit to Celsius
20 DEF FNTF(X) = X*9/5+32 : REM Celsius to Farenheit
21 PRINT : INPUT "Enter: Number Decimal to RT "; N1
22 DEF FNR(X) = INT(X*10^N1+.5)/10^N1
3800 REM Math Subroutines
3801 REM-----Deg, Min, Sec to Radians
3802 A = D+M/60 + S/3600
3803 A = (A*PI/180-2*PI*INT(A/360))
3809 RETURN
3820 REM-----Radian to Deg, Min, Sec
3821 A = 3600*180*R/PI : REM Total Sec
3822 B = INT(A/3600) : REM Total Deg
3823 C = INT(B/360) : REM Number Circle
3824 D = B-360*C : REM Deg
3825 Z = A-B*3600
3826 M = INT(Z/60) : REM Min
3827 S = Z-M*60 : REM Sec
3829 RETURN
3859 REM-----Significant figures
3860 IF N1 = 0 THEN 3879
3866 INPUT "Enter # Sig Fig "; M1
3868 N2 = ABS(N1) : M2 = LOG(N2)/LOG(10) : M3 = INT(M2+100)
3869 N3 = N2*10^(M1-(M3-99)) : N4 = INT(N3+.5)
3872 IF N3-INT(N3) <> .5 THEN 3878
3874 N5 = INT(N3)-INT(N3/10)*10 : IF INT(N5/2) <> N5/2 THEN 3877
3876 N4 = INT(N3) : GOTO 3878
3877 N4 = INT(N3+1)
3878 N1 = N4*10^(M3-99)-M1*SGN(N1)
3879 RETURN
3899 END
    
```

MICRO

## CSE means OSI

Software and Hardware  
Specializing in C1P and C4P machines

### Basic Load/SAVE:

Employs token loader system. 50-100% faster than the old indirect ASCII system. Maintains a listing of file names found on the tape

C1P.....\$10.95  
C4P.....\$19.95\*

### Basic Enhancer:

Renumber, Auto Sequencer, Screen Control functions, and tape I/O system that is faster and has file names

C1P.....\$21.95  
C4P.....\$29.95\*

\*comes with required modified monitor Rom chip

### NEW! NEW! NEW!

ANCHOR SIGNALMAN MODEMS .....\$95.00

Please write for more info on new disk programs or send \$2.00 for catalog. Please include \$2.00 shipping (\$4.00 for modems).

Computer  
Science  
Engineering



Box 50 • 291 Huntington Ave. Boston 02115

# MICRO™

## is publishing an OSI book!

OSI users will be getting a book of their own. Early in 1983, **MICRO** magazine plans to publish a strictly **OSI** volume!

It will cover a variety of topics—*BASIC Enhancements, Machine-Language Aids, Hardware, I/O Enhancements*, and a "What's *Where in the OSI*" reference guide.

Look for more details  
in upcoming issues of **MICRO**



## HEROES WANTED!

It takes the stuff of heroes to challenge Tharolia. For this gigantic planet is guarded by robotic spacefighters and automatic defenses programmed for one purpose: kill.

Our interstellar expansion will come to a halt unless you can blast through the swarms of automated ships, enter the devilish Tharolian Tunnels—elude the traps, and fight your way through tunnel after tunnel.

It will take uncommon dexterity, speed and courage to master the tunnels and destroy the robotic defense system. Heroes only are wanted, the faint hearted need not apply.

**\$29.95** for Apple II\* joystick/paddles

At your computer store, or:

 **DATAMOST**<sup>INC</sup>

9748 Cozycroft Ave., Chatsworth, CA 91311. (213) 709-1202.

VISA/MASTERCARD accepted. \$2.00 shipping/handling charge.  
(California residents add 6 1/2% sales tax.)

\*Apple II is a trademark of Apple Computer, Inc.

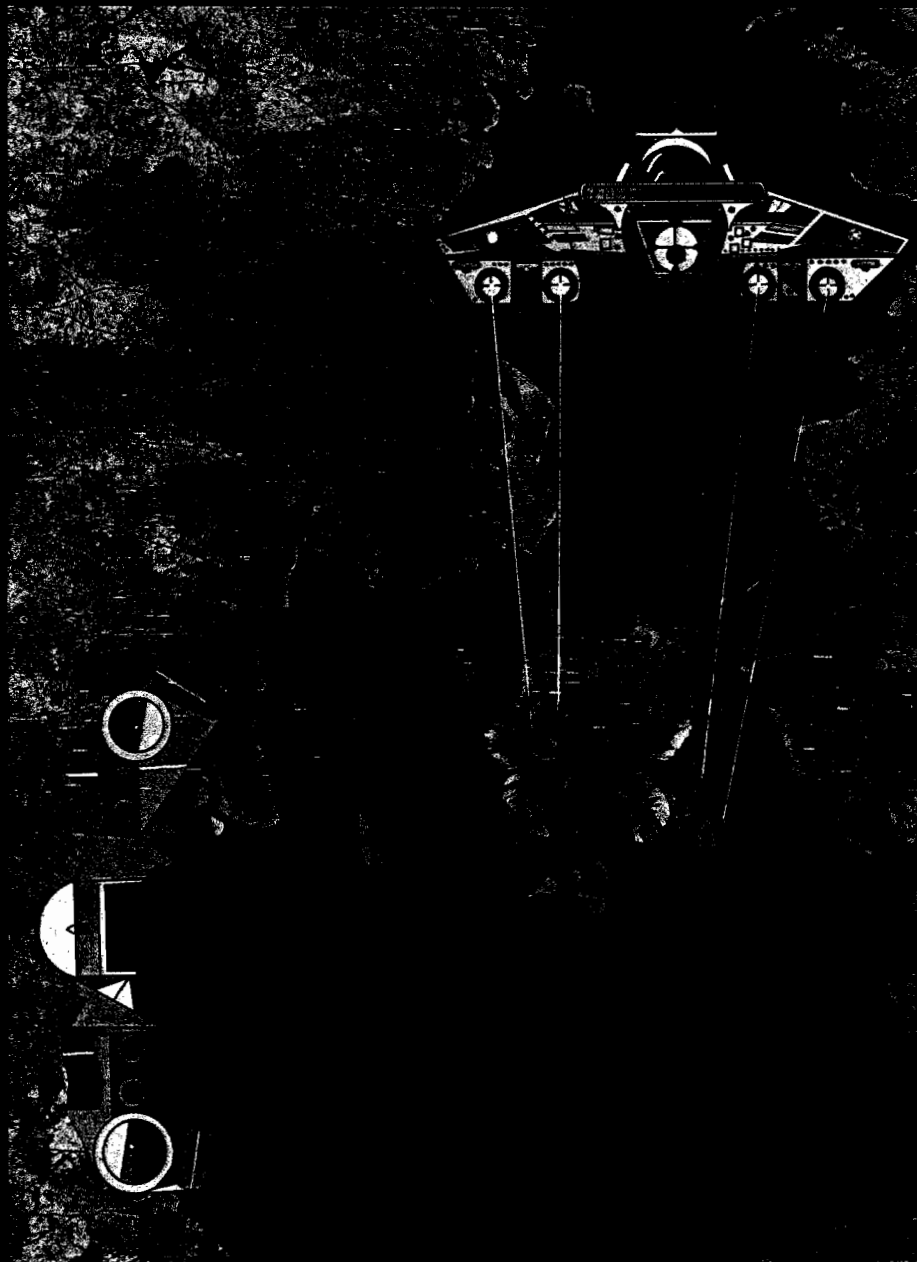

By John Steiner

This month, in addition to news, I discuss some of the books available for the Color Computer and the 6809. I also examine how to set up a high-resolution graphics display on the CoCo.

Last month I mentioned rumors of a new Color Computer built by Radio Shack, available through RCA. The machine, TDP System 100, should be available from RCA dealers by the time you read this. Considering the power of the Color Computer, I expect other CoCo "clones" will appear soon.

A unique accessory now available from several companies is an expansion unit. The unit plugs into the existing ROM pack and provides several extra expansion slots where drive controller, printer card, ROM packs, and other accessories can remain connected at all times. I look forward to testing one of these units for utility and ease of use. I will keep you posted.

By the time you read this, I am sure many of you will know of the death of Mr. Arnold C. Pouch. A retired IBM programmer, Mr. Pouch was one of the first to realize the power of Color Computer graphics. His Motion Picture Programming techniques for CoCo set a standard in graphics programs, and he created many other excellent utilities, including Disk Doctor. His company, Superior Graphics Software, will continue to operate, according to Mrs. Pouch.

When the snow flies and the early winter darkness descends, many people settle down with a good book by the roaring fire. What better way to spend an evening than to read about your favorite computer? In the past few months, several books have been released providing information and programs for both CoCo and the 6809. Subjects range from general purpose programs to high-resolution graphics tutorials.

A good programming book for beginners is one of a series written for many different home computers: Bob Albrecht's *TRS-80 Color BASIC*, published by John Wiley & Sons. Mr.

Albrecht assumes no previous knowledge of BASIC, and in an entertaining manner teaches much about CoCo. The book lacks only a discussion of the features of Extended Color BASIC.

Two excellent books covering graphics are *TRS-80 Color Computer Graphics* by Don Inman with Dymax [Reston Publishing Co.], and *Color Computer Graphics* by William Barden, Jr. [Radio Shack]. Mr. Inman's explanation of graphics operations and sound and joystick usage is well written. An entire chapter on machine-language USR routines is included.

Mr. Barden explains the graphics commands found in Extended Color BASIC, and covers the details of the 6847 video display generator and the CoCo memory map. The appendices are a rich source of video display information. For \$5.95, *Color Computer Graphics* is the least expensive book mentioned here.

*TRS-80 Programs and Applications*, by Alfred Baker, contains many beginner-level programs for the CoCo. If you are new to programming, you will like the fully documented program listings. (This book is not for the intermediate or advanced programmer.) One of the first programs in the book is a joystick test routine that checks the keyboard to see if a joystick fire button has been depressed. In ROM 1.0, this is acceptable. In ROM 1.1, the keyboard is isolated from the joystick port and pressing the fire button will have no effect on this program.

For CoCo owners who want to learn machine-language programming on the Color Computer, there is little to choose from. Two new releases may be available by the time you read this. William Barden, Jr., is writing a book for use with EDTASM+. It will be available from Radio Shack. Don Inman, who wrote an excellent book on machine language for the Apple, will soon have one for the Color Computer.

Books covering the 6809 processor and machine-language programming are more plentiful. A good reference source, *The MC6809 Cookbook* by Carl D. Warren [TAB Books], is written

for the experienced programmer upgrading to the 6809. *6809 Microcomputer Programming and Interfacing*, by Andrew Staugard, Jr., [Howard W. Sams & Co.], discusses the 6820 and 6821 PIAs in addition to the 6809. The 6821 is used in I/O applications for the Color Computer.

Probably the most detailed discussion of 6809 programming and applications is found in Lance Leventhal's *6809 Assembly Language Programming*. It is possible to learn machine-language programming from the beginning with this text, but the routines will not work unmodified on your CoCo assembler unless you can work on memory page zero.

*Programming the 6809*, by Rodney Zaks and William Labiak, covers elementary and intermediate programming techniques. Again, program modification may be required for the Color Computer.

This list is by no means complete, and discusses only books that I have had an opportunity to purchase. If you have information concerning other CoCo or 6809 reference sources, let me know and I will mention them in future columns.

Extended Color BASIC is probably one of the easiest graphics extensions available. In addition, other useful features are available in the ECB ROM. Although the ECB manual is easy to understand, it leaves some questions concerning the proper set-up of graphics screens. The simple, step-by-step list below should help ensure that all options are covered.

### CoCo Graphics Screen Initialization

1. Reserve the correct number of graphics pages. CoCo needs 1.5K of memory for each page reserved. The number of pages needed depends on the resolution you want and the number of separate screens to be held in memory. PCLEAR reserves between one and eight pages for graphics use.
2. Choose the mode you want. The mode determines the resolution and color combinations displayed. There

are three two-color modes and two four-color modes. PMODE identifies the mode and page on which the image will be placed.

3. Choose the color set you want and call the graphics screen. Use the SCREEN command to set this up. You can choose from two text screens and two color sets.
4. Select the foreground and background colors you want. This step allows you to create a display without specifying color in individual commands. COLOR sets this parameter.

All Extended Color BASIC graphics programs use these commands in one form or another to set up the display. Efficient use of these commands makes high speed, high-resolution graphics programming available to the BASIC programmer.

Next month, in addition to news, I will take a look at some hooks to RAM from the BASIC ROMs. A list pager program will demonstrate the use of these hooks.

**MICRO**

# MICRO™

## New Publications

**Survey** consists of three sections: Personal Computers, Engineering, and General Interest. It is published bi-monthly. For further information and to receive a sample pre-publication issue, send name and address with \$2 to KVA Associates, 2821 Camino del Mar, Del Mar, CA 92014. Phone (714) 755-0041.

**The Computer Tutor, Learning Activities for Homes and Schools**, by Gary W. Orwig and William S. Hodges. Winthrop Publishers, Inc. (17 Dunster Street, Cambridge, MA), 1982, 203 pages, 8½ × 11 inches, paperback. ISBN: 0-87626-147-0 \$10.95

**Programming the 6809**, by Rodnay Zaks and William Labiak. Sybex (2344 Sixth St., Berkeley, CA 94710), 1982, 520 pages, paperback. ISBN: 0-89588-078-4 \$14.95

**Introduction to WordStar**, by Arthur Naiman. Sybex (2344 Sixth St., Berkeley, CA 94710), 1982, 220 pages, paperback. ISBN: 0-89588-077-6 \$8.95

**Data Communications for Microcomputers: With Practical Applications and Experiments**, by Elizabeth A. Nichols, Joseph C. Nichols, and Keith R. Musson. McGraw Hill Book Company (1221 Avenue of the Americas, New York, NY 10020), 1982, 264 pages, paperback. ISBN: 0-07-046480-4 \$16.95

**WRITE, EDIT, & PRINT: Word Processing with Personal Computers**, by Donald H. McCunn. Design Enterprises of S.F. (P.O. Box 14695, San Francisco, CA 94114), 1982, paperback. ISBN: 0-932538-06-1 \$24.95

**Word Processing Primer**, by Mitchell Waite and Julie Arca. BYTE Books/McGraw Hill (1221 Avenue of the Americas, New York, NY 10020), 1982, 188 pages, paperback. ISBN: 0-07-067761-1 \$14.95

**Fortran Programs for Scientists and Engineers**, by Alan R. Miller. Sybex (2344 Sixth Street, Berkeley, CA 94710), 1982, 320 pages, paperback. ISBN: 0-89588-082-2 \$15.95

**Introduction to the UCSD p-System**, by Charles W. Grant and Jon Butah. Sybex (2344 Sixth St., Berkeley, CA 94710), 1982, 300 pages, paperback. ISBN: 0-89588-061-X \$14.95

**VIC Innovative Computing**, by Clifford Ramshaw. Melbourne House Publishers (347 Reedwood Drive, Nashville, TN 37217), 1982, 151 pages, paperback. ISBN: 0-86161 108-X \$14.95

**User's Guide to PET/CBM Computers**, by Jeffrey R. Weber. Weber Systems (8437 Mayfield Road, Cleveland, OH 44026), 1982, 324 pages, paperback. ISBN: 0-9604892-8-2 \$14.95

**Basic BASIC-English Dictionary for the Apple, PET, and TRS-80**, by Larry Noonan. dilithium Press (Beaverton, OR), 1982, 150 pages, paperback. ISBN: 0-918398-54-1 \$10.95

## WHAT'S WHERE IN THE APPLE A Complete Guide to the Apple Computer

This **REVISED EDITION** of the famous Apple Atlas provides Apple computerists with a framework for understanding both the overall organization and structure of the Apple system and programming techniques that exploit that knowledge.

*What's Where in the Apple* contains the most complete memory map ever published as well as detailed information needed for actual programming.

**All for only \$24.95**  
(plus \$5.00 s/h)

For owners of the original edition, MICRO is offering a companion book, *THE GUIDE to What's Where in the Apple*, for only **\$9.95** (plus \$2.00 s/h)

*THE GUIDE* contains all new material that explains and demonstrates how to use the atlas and gazetteer published in the original volume of *What's Where in the Apple?*

**VISA and MasterCard accepted**

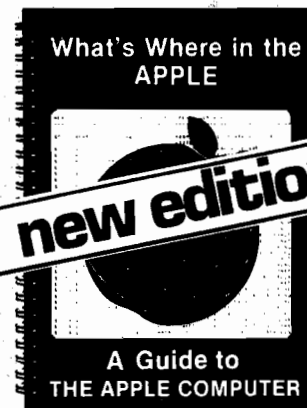

MICRO makes it easy to order!  
Send check to:

**MICRO INK**  
P.O. Box 6502  
Chelmsford, MA 01824

Or call our toll-free number:

**1-800-345-8112**  
(In PA, 1-800-662-2444)

**MA residents add 5% sales tax**



## Reviews in Brief

**Product Name:** The Disk Doctor  
**Equip. req'd:** TRS-80C disk, 32K  
**Price:** \$49.95  
**Manufacturer:** Superior Graphic Software  
406 Little Mountain Road  
Waynesville, NC 28786

**Description:** *The Disk Doctor* is a disk-salvage program for the Color Computer. The doctor will assist in transferring files from a "crashed" disk onto a different disk. Programs can be recovered even if the disk directory and allocation tables have been destroyed. Included with the package are an eight-page operation guide, a sample "crashed" disk, and the system disk. *Disk Doctor* is written in BASIC, and can be easily modified.

**Pluses:** The program is capable of reconstructing lost disk files in their entirety, no matter what their file type. Running *Disk Doctor* on machine-language files before the disk crashes gives a printout of ML start, end, and execute addresses. A wealth of information on preventative maintenance of disks is provided.

**Minuses:** *The Disk Doctor* has only one minor limitation — when salvaging a file larger than 12,288 bytes and you try to continue the transfer operation past the last graphics page, the transfer program overwrites *The Disk Doctor*. If this happens, the transfer procedure must be restarted from the beginning. This file size limitation is noted in the instructions and is easily avoided if you are careful.

**Documentation:** *The Disk Doctor* is full of "medical" information on sick disks. There are no lists of instructions, but the operator is guided through a disk reconstruction using the included crashed disk.

**Skill level required:** A knowledge of the disk file structure is helpful, and the user is referred to the Color Computer disk-system manual for preliminary information.

**Reviewer:** John Steiner

**Product Name:** OSI Greatest Hits  
**Equip. req'd:** OSI 1P or Superboard  
**Price:** \$29.95 plus \$1.50 shipping  
**Manufacturer:** Victory Software Corp.  
2027-A S.J. Russell Circle  
Elkins Park, PA 19117

**Description:** *Greatest Hits* is a collection of original programs for the OSI 1P computer. The programs fill both sides of two cassette tapes. Tape one contains 18 game programs; Night Rider, Cosmic Debris, Minos, Street Sweeper, Ridge Cruiser, and Worm are excellent games with good graphics effects. The second tape contains 16

utility programs. The two tapes represent nearly two hours of programs at 300 baud.

**Pluses:** The user can list, study, and modify these BASIC programs. A number of machine-code subroutines are used to increase the graphics speed and create some impressive effects. Smooth movement is obtained by clever use of the OSI character set. Some programs even let the player record his initials when he makes a new high score — just like the "real" arcades.

**Minuses:** The programs with graphics are written specifically for the 1P screen and ROM BASIC. These programs will need modification to run on any other OSI machine. The keys used to move UP, DOWN, LEFT, and RIGHT are not consistent among the various games. The user will have to modify the programs to fit his particular joystick hook-up. The utility programs are not of wide general interest; however, you may find one or two that fit your needs.

**Documentation:** A brief description and rules for each game are provided. Program listings are available at additional cost.

**Skill level required:** Good hand-eye coordination and fast reflexes.

**Reviewer:** E.D. Morris

**Product Name:** Basic'  
**Equip. req'd:** Apple II or Apple II Plus  
One disk drive  
**Price:** \$129.00  
**Manufacturer:** Delta Micro Systems, Inc.  
P.O. Box 15951  
1022 Harmony Street  
New Orleans, LA 70175  
(504) 895-1481

**Description:** This program development system for BASIC consists of a text editor, a preprocessor, a menu program, and a special disk operating system that detects the presence of a special protection chip that plugs into the game I/O socket of the Apple. The heart of the software is a preprocessor program that accepts a program written in the *Basic'* language (a structured dialect of BASIC) and produces Applesoft programs as output. *Basic'* provides the advantages of structured control statements that ordinary BASIC does not have: REPEAT-UNTIL, CASE, IF-ELSE, and PROC (named procedures without parameters).

**Pluses:** *Basic'* provides an easy way for those already

## Reviews in Brief *(continued)*

familiar with BASIC programming to learn the principle of structured programming.

**Minuses:** The system imposes limits on the size of source files. This could make large program development awkward, since the editor evidently does not make it easy to shift chunks of one source file to another. Thus, when one file fills up and you want to insert a bunch of new code in the middle of it, it would be necessary to key in the tail end of that file all over again in another text file. (*Editor's note:* there is a procedure in the manual to eliminate rekeying. Computer Assisted Analysis and Interactive Sports Systems have also developed large-scale BASIC programs using this system.) The system is menu-driven and does not allow the use of an eighty-column display card. *Basic'* generates Applesoft source code, which is equivalent to the source code written in *Basic'*.

**Documentation:** Well written, concise, and attractively packaged.

**Skill level required:** Knowledge of BASIC and a desire to learn structured programming.

**Reviewer:** Richard Vile

---

Product Name: **ColorZAP**  
Equip. req'd: TRS-80C, RS disk system  
Price: \$49.95  
Manufacturer: Software Options, Inc.  
19 Rector Street  
New York, NY 10006

**Description:** *ColorZAP* is a BASIC program with machine-language routines that allow the user to examine, change, or copy data on Color Computer diskettes. *ColorZAP* will access four drives and remains in memory so that all drives are available for program use. The program will display all sectors, or display sectors in a given file. Sectors can be verified for accuracy.

**Pluses:** *ColorZAP* quickly moves from sector to sector, forward or backward by pressing the + or - key. Direct access to any sector is allowed. A cursor-controlled screen editor modifies individual bytes. All changes are made in memory and transferred to the disk only when you are ready. A convert routine allows you to convert granule numbers into the track and sector numbers required for data file access.

**Minuses:** None noted.

**Documentation:** A 24-page manual describes program operation in detail and provides valuable information on disk system parameters.

**Skill level required:** A solid basic knowledge of disk file structure is necessary, especially when trying to reconstruct a defective or killed file.

**Reviewer:** John Steiner

*(continued)*

# It Pays to Write for MICRO!

---

Get paid for your ideas: write for MICRO! Thousands of people read MICRO every month. MICRO is sold in computer stores and on newsstands worldwide. Send for a copy of our *Writer's Guide* now. Our author payment rate is competitive with the leading magazines in the industry.

We welcome articles on any aspect of 6502/6809/68000 hardware and software for the Apple, Atari, C B M / P E T, VIC, OSI, TRS-80 Color Computer, 6809, or 68000.

---

## 1983 Editorial Schedule

Month/Feature	Deadline for Articles
April—Communications	December 17
May—Wave of New Computers	January 14
June—Operating Systems	February 16
July—Hardware	March 18
August—Word Processing	April 15
September—Education	May 13
October—Programming Techniques	June 17
November—Games	July 15
December—New Microprocessors	August 12

---

Send your articles to:  
**Editor, MICRO, P.O. Box 6502,  
Chelmsford, MA 01824**

## Reviews in Brief *(continued)*

Product Name: **VIE (VIC IEEE Interface)**  
Equip. req'd: VIC-20 (5K or more)  
PET to IEEE cable  
IEEE Device(s)  
Price: \$99.95  
Manufacturer: Micro-Systems  
11105 Shady Trail #104  
Dallas, Texas 75229

**Description:** VIE is a cartridge-like unit that plugs into the expansion port of the VIC-20 and enables the VIC to communicate with IEEE devices like the PET/CBM 2022 printer and 4040 disk drives. A PET to IEEE cable (not provided) attaches to the side of the VIE. The VIE also has an expansion slot so other cartridges may be attached to the VIC without removing the VIE. Approximately 1K of ROM software is built into the VIE which is accessed by a SYS40000 command to initialize the interface. Once initialized, communication with any IEEE device is by direct commands or from within a program.

**Pluses:** The VIE is reliable and extremely easy to use. It takes no memory away from the VIC, nor interferes with normal operation. It's attractively packaged and comes in a hard plastic case that matches the VIC's case and color.

**Minuses:** The expansion slot on the VIE is positioned so that added cartridges are vertical. Inserting cartridges into the VIE can cause stress on the VIC's expansion connection. Adding a piece of wood under the VIE will solve this problem.

**Documentation:** The VIE comes with a single page of documentation that covers everything quite well.

**Skill level required:** The user should understand the commands needed to communicate with his IEEE devices.

**Reviewer:** David Malmberg

---

Product Name: **Type 'N Talk  
Text-to-Speech Synthesizer**  
Equip. req'd: Virtually all personal computers  
Price: \$249.00 (plus cable)  
Interface cable for VIC and 64 - \$34.95  
For other computers - \$24.95  
Manufacturer: Votrax, Inc/  
Federal Screw Works Division  
Consumer Products Group  
500 Stephenson Highway  
Troy, MI 48084

**Description:** *Type 'N Talk* is a completely self-contained text-to-speech synthesizer that attaches to your computer via an RS-232C serial port. When you open a file and write to this port using BASIC or other languages, the text you write is converted to speech. The speech sounds mechanical, but the overall quality is good and understandable. If you have a VIC-20 or Commodore-64, you will need a special cable available from Votrax that attaches to the user port. The *Type 'N Talk* has its own microprocessor and buffer (with enough capacity to hold a minute's worth of speech), so speech can occur while the host computer is doing something else. The text-to-speech synthesizer

creates speech from electronic phonemes that give an unlimited vocabulary and the ability to speak languages other than English. The unit has a built-in amplifier with volume and frequency controls and a jack to plug in a speaker (not provided).

**Pluses:** *Type 'N Talk* works well once you overcome the lack of any practical examples in the documentation. The unit is fun (especially for children) and is an impressive demonstration of your computer's power.

**Minuses:** See Documentation.

**Documentation:** A 32-page manual primarily addressed to engineers and/or hardware experts. There is no additional documentation.

**Skill level required:** None.

**Reviewer:** David Malmberg

---

Product Name: **Printographer**  
Equip. req'd: Apple II Plus  
Any of the popular printers  
Price: \$49.95  
Manufacturer: Southwestern Data Systems  
P.O. Box 582  
Santee, CA 92071

**Description:** A versatile screen-dump program designed for ease of use interfaces routines for most of the Apple-compatible printers currently available. Features to "crop" a picture permit you to print only desired parts of a picture. The manufacturer's standard backup facility provides a maximum of three copies to be made.

**Pluses:** Pictures can be positioned on a page both horizontally and vertically. A magnification feature allows you to blow up and print just a portion of a picture. A subroutine permits printing under Applesoft control.

**Minuses:** None noted.

**Documentation:** Well written; numerous illustrated examples speed the familiarization process.

**Skill level required:** A beginning BASIC programmer should have no trouble.

**Reviewer:** Chris Williams

---

Product Name: **Chromasette Magazine**  
Equip. req'd: TRS-80C w/Extended BASIC  
Price: \$45.00/year or \$5.00 each  
Manufacturer: Chromasette Magazine  
P.O. Box 1087  
Santa Barbara, CA 93102

**Description:** *Chromasette* is a monthly magazine with approximately six programs on cassette for the Color Computer. Programs range in nature from games to utilities or home-management software. All tapes include a graphics cover program. Some programs are written especially for the CoCo disk system.

*(continued)*

## Reviews in Brief *(continued)*

---

**Pluses:** An interesting newsletter that accompanies the cassette provides information on using the programs, bugs found in previous issues, reader modifications, and short program listings not found on the tape. It is an inexpensive source of CoCo software for a wide variety of applications. Where possible, tape-to-disk conversion information is included.

**Minuses:** Not all programs are usable on all machines. You must have Extended BASIC to run most of the programs.

**Documentation:** Provided in the accompanying newsletter, typically four to six pages.

**Skill level required:** Programs are provided for all levels, from novice to hardware hacker.

**Reviewer:** John Steiner

---

Product Name: **VIC Expansion Module**  
Equip. req'd: VIC-20 (5K or more)  
Price: \$49.95  
Manufacturer: Parsec Research  
P.O. Drawer 1766  
Fremont, CA 94538

**Description:** The *VIC Expansion Module* plugs into the expansion port in the back of your VIC and enables you to have up to three cartridges operable simultaneously. Using this module, you can add up to 32K of additional RAM memory, or combinations of RAM and utility cartridges like the toolkit or machine-language monitor.

**Pluses:** It works reliably. The module is well made with double-gold plating throughout. It is designed to rest flush with the table, so inserting cartridges will not put any stress on the VIC expansion connectors.

**Minuses:** The unit's black color does not go well with the rest of the VIC's color scheme.

**Documentation:** Clear and concise. The module also comes with a detailed memory map and instructions on how to set the DIP switches in Commodore's 8K RAM cartridges to correspond to any 8K block.

**Skill level required:** None.

**Reviewer:** David Malmberg

---

Product Name: **80C Disassembler**  
Equip. req'd: TRS-80 Color Computer plus printer  
Price: \$49.95  
Manufacturer: The Micro Works  
P.O. Box 1110  
Del Mar, CA 92014

**Description:** *80C Disassembler* is a tape-based 6809 assembly-language disassembler specifically tailored to the Color Computer. The output from the disassembler can be any one of three formats. Users with an 80-column printer can specify the "full output" mode that lists an ad-

dress, the machine code (one to five bytes for a 6809), the effective address specified by the instruction, ASCII characters represented by the code, and the assembly-language statement deduced from the code. Users with a narrow-format printer can get the "full output" printed with a special indented format that eases interpretation of the data. During program set-up, the user can specify various types of code areas within the program.

**Pluses:** This software is highly user-oriented; the experienced user can glean a maximum of information in a minimum of time.

**Minuses:** Not available in ROM; but such use may be too specialized to warrant production.

**Documentation:** Thorough and clearly written.

**Skill level required:** Novice assembly-language programmer.

**Reviewer:** Ralph Tenny

---

Product Name: **The Software Automatic Mouth (S.A.M.)**  
Equip. req'd: Apple II with Applesoft  
48K RAM and DOS 3.3  
Price: \$124.95  
Manufacturer: Don't Ask Computer Software  
2265 Westwood Blvd.  
Suite B-150  
Los Angeles, CA 90064

**Description:** This software voice synthesizer generates clear speech from strings of phonemes (speech sounds represented by about 50 unique letter combinations), with programmable pitch, speed, and inflection. A program to translate English text directly to speech is included. To use *S.A.M.* from Applesoft, BLOAD *S.A.M.*, assign the string to be spoken to SA\$, CALL an address, and *S.A.M.* speaks. Connection to an external speaker is through the included plug-in card.

**Pluses:** Speech is clear and expressive, easy to generate and manipulate from Applesoft or assembly language. The disk is unprotected. This is an outstanding and fascinating product at a reasonable price.

**Minuses:** *S.A.M.* programs will not work on other Apple models without a converter card.

**Documentation:** The excellent, thorough manual includes a 1500-word phonetic spelling dictionary.

**Skill level required:** None to enjoy the demonstration programs; ordinary knowledge of BASIC to use *S.A.M.* in programs.

**Reviewer:** Jon R. Voskuil

---

**PRODUCTS FOR ATARI\* 400/800  
FROM ELCOMP**

**BOOKS:**

**ATARI BASIC - Learning by using**  
An excellent book for the beginner. Many short programs and learning exercises. All important features of the ATARI computers are described (screen drawings, special sounds, keys, paddles, joysticks, specialized screen routines, graphics, sound applications, peeks, pokes, and special stuff). Also suggestions are made that challenge you to change and write program routines.  
Order # 164 \$7.95



**GAMES for the ATARI Computer**  
This book describes advanced programming techniques like player-missile-graphics and use of the hardware-registers. Contains many ready to run programs in BASIC and one called GUNFIGHT in machine-language.  
Order # 162 \$7.95

**SOFTWARE IN BASIC FOR ATARI**

**Invoice Writing for Small Business**  
This program makes writing invoices easy. Store your products in DATA statements with order-number, description, and price. The program later retrieves the description and price matching to the entered order-number. The shipping cost and the discount may be calculated automatically depending on the quantity ordered or entered manually. The description to the program tells you how to change the program and adapt it to your own needs. Comes with a couple of invoice forms to write your first invoices on to it.  
Order # 7201 cassette version \$29.95  
Order # 7200 disk version \$39.95

**Mailing List**  
This menu driven program allows the small business man to keep track of vendors and customers. You can search for a name or address of a certain town or for an address with a certain note. 50 addresses are put into one file.  
Order # 7212 cassette version \$19.95  
Order # 7213 disk version \$24.95

**Inventory Control**  
This program is menu driven. It gives you the following options: read/store data, define items, entry editing, inventory maintenance (incoming-outgoing), reports. The products are stored with inventory number, manufacturer, reorder level, present level, code number, description.  
Order # 7214 cassette version \$19.95  
Order # 7215 disk version \$24.95

**Programs from Book # 164**  
The programs from book no. 164 on cassette. (Book included)  
Order # 7100 \$29.00

**Game Package**  
Games on cassette. (Bomber, tennis, smart, cannon fodder, etc.)  
Order # 7216 \$9.95



**Microcomputer Hardware Handbook** (845 pages)  
Descriptions, pinouts and specifications of the most popular microprocessors and support chips.  
A MUST for the hardware buff.  
Order No. 29 \$14.95

**Care and Feeding of the Commodore PET**  
Eight chapters exploring PET hardware. Includes repair and interfacing information. Programming tricks and schematics.  
Order # 150 \$9.95

# ELCOMP

Payment: check, money order, VISA, MASTERCARD, Eurocheck.  
Orders from outside USA: add 15% shipping. CA residents add 6.5% tax  
\*ATARI is a registered trademark of ATARI Inc.  
\*VIC-20 is a registered trademark of Commodore

ELCOMP Publishing Inc.,  
53 Redrock Lane  
Pomona CA 91766,  
Phone: (714) 623-8314

Books  
+  
Software  
for  
ATARI  
VIC-20  
OSI  
SINCLAIR  
TIMEX

**SOFTWARE IN MACHINE LANGUAGE for ATARI**

**ATMONA-1**  
This is a machine language monitor that provides you with the most important commands for programming in machine-language. Disassemble, dump (hex and ASCII), change memory location, block transfer, fill memory block, save and load machine-language programs, start programs. Printer option via three different interfaces.  
Order # 7022 cassette version \$19.95  
Order # 7023 disk version \$24.95  
Order # 7024 cartridge version \$59.00

**ATMONA-2**  
This is a tracer (debugger) that lets you explore the ATARI RAM/ROM area. You can stop at previously selected address, opcode, or operand. Also very valuable in understanding the microprocessor. At each stop, all registers of the CPU may be changed. Includes ATMONA-1.  
Order # 7049 cassette version \$49.95  
Order # 7050 disk version \$54.00

**ATMAS**  
Macro-Assembler for ATARI-800/48k. One of the most powerful editor assemblers on the market. Versatile editor with scrolling. Up to 17k of source-code. Very fast, translates 5k source-code in about 5 seconds. Source code can be saved on disk or cassette. (Includes ATMONA-1)  
Order # 7099 disk version \$89.00  
Order # 7999 cartridge version \$129.00

**ATAS**  
Same as ATMAS but without macro-capability. Cassette-based.  
Order # 7098 32k RAM \$49.95  
Order # 7998 48k RAM \$49.95

**ATEXT-1**  
This wordprocessor is an excellent buy for your money. It features screen oriented editing, scrolling, string search (even nested), left and right margin justification. Over 30 commands. Text can be saved on disk or cassette.  
Order # 7210 cassette version \$29.95  
Order # 7216 disk version \$34.95  
Order # 7217 cartridge version \$69.00

**GUNFIGHT**  
This game (8k machine-language) needs two joysticks. Animation and sound. Two cowboys fight against each other. Comes on a bootable cassette.  
Order # 7207 \$19.95

**ELCOMP FORTH for the ATARI**

**ELCOMP FORTH** is an extended Fig-Forth-version, Editor and I/O package included. Utility package includes decompiler, sector copy, Hex-dump (ASCII), ATARI Filehandling, total graphic and sound, joystickprogram and player missile.  
Order # 7055 disk \$39.95

Floating point package for ELCOMP FORTH with trigonometric functions (0 - 90°).  
Order # 7230 disk \$29.95

**Learn-FORTH from ELCOMP**  
A subset of Fig-Forth for the beginner. On disk (32k RAM) or on cassette (16k RAM).  
Order # 7053 \$19.95

**Expansion boards for the APPLE II**

**The Custom Apple + Other Mysteries**  
A complete guide to customizing the Apple Software and Hardware  
Order-No. 680 \$24.95  
We also stock the boards which are used in the book "The Custom Apple..." (bareboards)  
6522 I/O Board No. 605 \$39.00  
EPROM Burner No. 607 \$49.00  
8K EPROM/RAM Board No. 609 \$29.00

Prototyping board for the Apple II No. 604 \$29.00  
Slot repeater board for the Apple II No. 606 \$49.00  
Order two boards and get the book free!  
No. 6153 Learn FORTH for the Apple II (C) \$19.95  
No. 6154 Learn FORTH for the Apple II (D) \$24.95  
No. 6155 ELCOMP FORTH for the Apple II (D) \$39.95  
(Extended Fig-Forth, Editor, graphics package)  
No. 6156 Floating point for ELCOMP FORTH (D) \$29.95

**Hardware - ADD-ONS for ATARI**

**PRINTER INTERFACE**  
This construction article comes with printed circuit board and software. You can use the EPSON printer without the ATARI printer interface. (Works with gameports 3 and 4).  
Order # 7211 \$19.95

**RS-232 Interface for your ATARI 400/800**  
Software with connector and construction article.  
Order # 7291 \$19.95

**EPROM BURNER for ATARI 400/800**  
Works with gameports. No additional power supply needed. Comes compl. assembled with software (2716, 2732, 2532).  
Order # 7042 \$179.00

**EPROM BURNER for ATARI 400/800 KIT**  
Printed circuit board incl. Software and extensive construction article.  
Order # 7292 \$49.00

**EPROM BOARD (CARTRIDGE)**  
Holds two 4k EPROMs (2532). EPROMs not included.  
Order # 7043 \$29.95

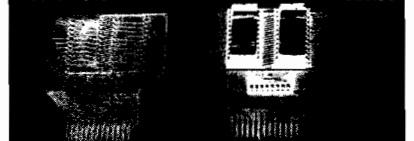

**EPROM BOARD KIT**  
Same as above but bare board only with description.  
Order # 7224 \$14.95

**ATARI, VIC-20, Sinclair, Timex and OSI**

**New - for your ATARI 400/800**  
**Astrology and Biorythm for ATARI** (cass. or disk).  
Order # 7223 \$29.95  
**Birth control with the ATARI** (Knaus Ogino)  
Order # 7222 cass. or disk \$29.95

**Books + Software for VIC-20 (requires 3k RAM Exp.)**  
# 4870 Wordprocessor for VIC-20, 8k RAM \$19.95  
# 4883 Mailing List for VIC-20, 16k RAM \$14.95  
# 141 Tricks for VICs - The VICStory Progr. \$9.95  
# 4880 TIC TAC VIC \$9.95  
# 4881 GAMEPACK I (3 Games) \$14.95  
# 4885 Dual Joystick Instruction \$9.95

**INPUT/OUTPUT Programming with your VIC**  
Order # 4886 \$9.95  
# 4896 Mini-assembler for VIC-20 \$19.95  
# 4881 Tennis, Squash, Break \$9.95  
# 4894 Runfill for VIC \$9.95

**Universal Experimenter Board for the VIC-20**  
(Save money with this great board). This board plugs right into the expansion slot of the VIC-20. The board contains a large prototyping area for your own circuit design and expansion. The construction article shows you how to build your own 3k RAM expander and ROM-board.  
Order # 4844 \$18.95

**Software for SINCLAIR ZX-81 and TIMEX 1000**  
# 2399 Machine Language Monitor \$9.95  
# 2398 Mailing List \$19.95  
**Programming in BASIC and machine language with the ZX-81 (82) or TIMEX 1000.**  
Order # 140 (book) \$9.95

**Books for OSI**  
# 157 The First Book of Ohio \$7.95  
# 158 The Second Book of Ohio \$7.95  
# 159 The Third Book of Ohio \$7.95  
# 160 The Fourth Book of Ohio \$7.95  
# 161 The Fifth Book of Ohio \$7.95

# 151 8K Microsoft BASIC Ref. Man. \$9.95  
# 152 Expansion Handbook for 6502 and 6802 \$9.95  
# 153 Microcomputer Appl. Notes \$9.95

**Complex Sound Generation**  
New revised applications manual for the Texas Instruments SN 76477 Complex Sound Generator.  
Order # 154 \$6.95

**Small Business Programs Order # 156**  
Complete listings for the business user. Inventory, Invoice Writing, Mailing List and much more. Introduction to Business Applications. \$14.90

## Software Catalog

Name: **Concentrated Chemical Concepts**

System: Apple II  
Memory: 48K  
Language: Applesoft  
Hardware: 3.3 DOS, disk drive

Description: This package of drill and practice programs covers the entire course in introductory general, organic, and biological chemistry for health science majors. The programs are intended for introductory college or advanced placement programs in high schools. No computer experience is necessary and complete documentation accompanies the programs.

Price: \$300.00 - Part I  
\$225.00 - Part II  
\$150.00 - Part III  
\$550.00 - all nine disks  
Part I (general) includes four disks, Part II (organic) includes three disks, and Part III (biology) includes two disks.

Author: Richard Cornelius  
Available:  
John Wiley & Sons, Inc.  
Eastern Distribution Center  
Order Processing Dept.  
1 Wiley Drive  
Somerset, NJ 08873

Name: **Pie Man**  
System: Apple II Plus  
Memory: 48K

Language: Machine language  
Description: As the pies come out of the oven onto a conveyor belt, you (the baker's apprentice) must get a can of whipped cream, squirt it on the pie, grab a cherry, put it on the pie, then take the finished pie and put it in the pie bin. Watch out for flour sacks and grease spots on the floor and the slightly tipsy wedding-cake baker delivering his creations. If you let seven pies fall to the floor, you're fired.

Price: \$29.95  
Includes disk and instruction booklet.

Author: Eagle Berns,  
Michael Kosaka

Available:  
Penguin Software  
830 4th Avenue  
Geneva, IL 60134

Name: **MicRo Quiz II**  
System: TRS-80 Model III,  
VIC-20  
Memory: 16K - TRS-80  
Model III  
8K - VIC-20

Language: BASIC  
Description: *MicRo Quiz II* is a subject-independent CAI authoring package with class evaluation features that requires no computer programming knowledge.

Price: \$39.95  
Includes comprehensive, easy-to-use instruction manual.

Available:  
M-R Information Systems,  
Incorporated  
P.O. Box 73  
Wayne, NJ 07470

Name: **Sensible Speller**  
System: Apple II, Apple II Plus  
Memory: 48K  
Language: 5 versions

available: Pascal, DOS 3.3, CP/M, Word Handler, and Super-Text  
Hardware: One or two disk drives

Description: A spelling-verification program designed specifically for the Apple. The official *Random House Dictionary*, Concise Edition (80,000 plus words) is included in both diskette and hardcover form. The average time to proofread a 10-page document (about 3350 words) is one minute if there are no spelling mistakes or two minutes, 15 seconds for many spelling mistakes. Shorter documents will take less time.

Price: \$125.00  
Includes instruction manual, two copies of the *Sensible Speller* program diskette, a main dictionary diskette, a hardcover copy of the *Random House Dictionary*, Concise Edition, and binder to hold the complete package.

Author: Charles Hartley

Available:  
Sensible Software  
6619 Perham Drive  
West Bloomfield, MI 48033  
(313) 399-8877

Name: **INTROL-C/6809 Compiler**

System: 6809 running FLEX, UniFLEX, OS-9, Z80/8080 running CP/M  
Memory: 48K plus 8K -FLEX-09  
40K free memory -OS-9  
60K - CP/M

Language: C  
Description: This is a full C compiler system for developing programs in C for 6809-based target applications. The software package includes a C compiler, 6809 assembler, linking loader, run-time library, and library manager. *INTROL-C/6809* supports virtually all standard C as defined by Kernighan and Ritchie. It is efficient both in terms of size and speed of execution. Compiled programs are re-entrant, relocatable, and ROMable.

Price: From \$475  
Includes floppy disk, user's manual, and one-year maintenance program.

Author: Richard Pennington  
Available:  
Introl Corp.  
647 W. Virginia St.  
Milwaukee, WI 53204  
(414) 276-2937

Name: **FilmTape**  
System: Apple II Plus  
Memory: 48K  
Language: Applesoft, compiled by Microsoft 'TASC'

Hardware: DOS 3.3 and printer

Description: *FilmTape* is designed to aid film editors and others who need rapid, frame-accurate translation of film times into television time codes. Working with a cut workprint and up to four O/S rolls, it can help trim up to 80% from on-line video editing times, often paying for itself in one session. Users may mix types of film and time code.

Price: \$395.00  
Includes diskette, manual, full support.

Available:  
Editing Services  
615 Fairground  
Plymouth, MI 48170  
(313) 459-4618

Name: **Economic Order Quantity (E.O.Q.) Package**

System: Apple II or IBM Personal Computer  
Memory: 48K/Apple  
64K/IBM

Hardware: Apple II — disk II disk controller and at least one disk II disk drive.  
IBM — 80-column video monitor, optional printer

Description: The *Execuware™ Economic Order Quantity (E.O.Q.) Package* provides the businessman with a tool to minimize overall inventory costs. The package calculates the Economic Order Quantity and the Order Point. The sensitivity analysis affords the user the opportunity to perform "what if" analysis and to determine which variables cause the EOQ and the Order Point to vary significantly. Probability theory is used to simulate the variable demand, thereby insuring realistic inventory levels at all times.

Price: \$174.95  
Includes instruction manual and diskette.

Author: Execuware™  
Microcomputer Software  
Division of Aeronca, Inc.

Available:  
Apple and IBM Personal Computer dealers

Name: **The Count**  
System: Apple II or Apple II Plus

Memory: 48K  
Language: Applesoft BASIC  
Hardware: DOS 3.3, one or more disk drives

Description: A winning Blackjack system; an interactive program which teaches strategies for playing-card counting, and betting for a winning Blackjack game.

Price: \$24.95  
Includes disk and manual.

Author: Pear Software

Available:  
Insoft, Inc.  
10175 S.W. Barbur Blvd.  
Suite 202B  
Portland, OR 97219

(continued)



## Software Catalog (continued)

**Name:** **Hockey**  
**System:** Atari 400/800  
**Memory:** 16K RAM  
**Language:** Assembler  
(Machine)  
**Hardware:** Two, three, or  
four joysticks,  
cassette recorder  
or disk drive  
**Description:** *Hockey* is a high-  
speed video action game for  
two, three, or four players. It is  
played on an enclosed rink,  
with scoreboard including  
clock overhead. Game players  
use joysticks to control the ac-  
tion. Offensive players skate  
with the puck, pass, and shoot.  
Defensive players steal the  
puck and intercept passes.  
Goalies block shots. *Hockey*  
includes "smart" players who  
perform automatically.  
**Price:** \$29.95  
**Available:**  
Gamma Software  
P.O. Box 25625  
Los Angeles, CA 90025  
(213) 473-7441

**Name:** **AMPER-SORT/  
MERGE II  
(A-S/M II)**  
**System:** Apple II  
**Memory:** 48K  
**Language:** Applesoft BASIC  
and machine  
language  
**Hardware:** DOS 3.3, disk  
drive  
**Description:** *AMPER-SORT/  
MERGE II* is a general-purpose  
disk sort/merge utility for  
Apple DOS text files. Its  
machine-language file can sort  
1000 records in seconds, alpha-  
numerically (ascending or  
descending order) on up to five  
fields, random or sequential  
text files, and merge two to  
five pre-sorted files into a  
single file. It is compatible  
with most data-base programs  
that create standard DOS 3.3  
text files. New features are  
S&H's super fast VisiFile index  
sort (callable from *within*  
VisiFile for effortless use) and  
a fast random access file in-  
dex sort.  
**Price:** \$69.95  
Includes disk and  
documentation.  
**Author:** Alan G. Hill  
**Available:**  
S&H Software  
58 Van Orden Road  
Harrington Park, NJ 07640  
(201) 768-3144

**Name:** **OMNIPACK**  
**System:** Apple II, Apple III  
**Memory:** 48K minimum -  
Apple II  
128K minimum -  
Apple III  
**Language:** BASIC and 6502  
machine language  
**Hardware:** At least one disk  
drive, printer  
optional  
**Description:** *OMNIPACK* con-  
sists of three separate pro-  
grams for which data files are  
fully interchangeable. *OMNI-  
FILE* is a powerful RAM-based  
file management system and  
report generator, with global  
editing, built-in statistical  
functions, and flexible output  
formatting. *OMNIGRAPH* is a  
versatile data-plotting program  
for constructing X-Y plots, bar  
charts, and pie charts. *OMNI-  
TREND* is a powerful  
multiple-regression trend-  
analysis program.  
**Price:** \$129.95 - Apple II  
\$169.95 - Apple III  
Includes two diskettes and  
user's manual.

**Author:** M.K. Booker  
**Available:**  
Educational Computing  
Systems  
136 Fairbanks Road  
Oak Ridge, TN 37839  
(615) 483-4915

**Name:** **A.S.A.P.**  
**System:** Apple II, Apple II  
Plus  
**Memory:** 48K  
**Language:** Apple Run-Time  
Environment for  
Pascal  
**Hardware:** One disk drive  
(5¼), THE MILL  
6809 co-processor  
**Description:** The system  
allows a wide variety of  
popular programs to utilize the  
power of THE MILL. Similar to  
the Pascal Speed Up System,  
A.S.A.P. works with software  
intended for the Run-Time En-  
vironment — including PFS  
and VisiSchedule. It increases  
speed in processing, compila-  
tion, and printing.  
**Price:** \$295.00  
Includes A.S.A.P. software  
and THE MILL.  
**Author:** SB Programming  
**Available:**  
Stellation Two  
The Lobero Bldg.  
P.O. Box 2342  
Santa Barbara, CA 93120  
(805) 966-1140

**Name:** **Interface**  
**System:** Apple II Plus  
**Memory:** 48K  
**Language:** Applesoft  
**Hardware:** DOS 3.3, disk  
drive  
**Description:** *Interface* reads  
numerical tables in three for-  
mats, transforms and re-  
arranges rows or columns, fits  
curves to data, and outputs  
files in several formats. The  
program's primary function is to  
translate from VisiCalc to  
Apple Plot, while adding flex-  
ibility and preventing er-  
roneous graphs. It also sup-  
plements VisiCalc with rank  
ordering, alphabetizing and  
curve fitting, and outputs  
tables to Apple Writer or  
VisiCalc itself.  
**Price:** \$30.00  
Includes instructions and  
copyable program disk.  
**Available:**  
Bill Starbuck  
2100 E. Edgewood  
Shorewood, WI 53211  
(414) 963-9750

**Name:** **Fractions**  
**System:** PET  
**Memory:** 16K  
**Language:** BASIC  
**Hardware:** Cassette player or  
disk drive  
**Description:** An overview pro-  
gram and a placement test pro-  
gram begin this carefully-  
structured sequence of 24 in-  
teractive programs. Eleven  
tutorial programs, each backed  
by a fun and challenging en-  
richment game program, help  
students (grade five and up)  
develop the confidence, con-  
cepts, and skills needed to  
master fractions.  
**Price:** \$175.00 for 12 tapes or  
6 diskettes  
Includes teacher's guide and  
software.  
**Author:** Joanne Benton  
**Available:**  
Quality Educational Designs  
P.O. Box 12486  
Portland, OR 97212  
(503) 287-8137

**Name:** **Guadalcanal  
Campaign**  
**System:** Apple II, Apple II  
Plus, or Apple III  
**Memory:** 48K  
**Language:** BASIC  
**Hardware:** One disk drive  
**Description:** The 294-turn  
campaign game takes into ac-  
count every Japanese and  
American warship that par-  
ticipated historically in the

campaign. Each is rated for  
speed, cargo/plane-carrying  
capacity, damage points, num-  
ber of main guns, secondary  
anti-aircraft guns and torpedo  
tubes. An abridged campaign  
(184 turns) is available as well  
as four mini-games which take  
only two to four hours to play.  
Game has both solitary and  
two-player versions.  
**Price:** \$59.95  
Includes one disk, rulebook,  
and two maps.  
**Author:** Gary Grigsby  
**Available:**  
Strategic Simulations Inc.  
465 Fairchild Dr.  
Suite 108  
Mt. View, CA 94043

**Name:** **Tax Dodge**  
**System:** Atari 400/800  
**Memory:** 32K  
**Language:** 6502 machine  
language  
**Description:** *Tax Dodge* is a  
scrolling maze game in which  
the taxed citizen tries to col-  
lect as much money as possi-  
ble without being hit by the  
tax collectors.  
**Price:** \$39.95  
**Author:** Jon Freeman,  
Anne Westfall  
**Available:**  
Island Graphics  
Box U  
Bethel Island, CA 94511

**Name:** **Seafox**  
**System:** Apple II, Apple II  
Plus, Atari  
400/800  
**Memory:** 48K  
**Language:** Machine language  
**Hardware:** Apple - keyboard,  
joystick, and  
paddle  
Atari - joystick  
**Description:** You are in control  
of a lone submarine looking for  
a convoy of enemy ships and  
its escort. Dodge exploding  
depth charges, avoid menacing  
mines, and evade speeding  
torpedos in an effort to elimi-  
nate the foe. You will need  
superior maneuvering ability,  
great courage, and a welcome  
aquatic ally to survive.  
**Price:** \$29.95  
**Author:** Ed Hobbs  
**Available:**  
Broderbund Software, Inc.  
1938 Fourth Street  
San Rafael, CA 94901  
(415) 456-6424

(Continued)

## Software Catalog *(continued)*

Name: **DSS/F Decision Support System/Finance**  
System: Apple  
Memory: 64K  
Language: Pascal  
Hardware: Disk drive, serial interface, Hewlett-Packard one, two, four, and eight pen plotters, or Houston Instrument plotters

Description: Micro *Decision Support System/Finance* (DSS/F) is a financial modeling and graphics system that assists managers, planners, and others with no previous computer knowledge to perform financial forecasting and reporting, investment analysis, cash flow forecasting, budgeting, consolidations, and strategic planning. Features include English modeling language, financial function, graphics, report generator, and sophisticated power.

Price: \$1500.00

Includes manuals, software, and support.

Available:  
Ferox Microsystems  
1701 N. Fort Myer Drive  
Arlington, VA 22209  
Attn. Phil Evans  
(703) 841-0800

Name: **Real Estate Analysis Package (REAP)**

System: Apple II, Apple II Plus  
Memory: 48K  
Hardware: One disk drive and printer

Description: The *Real Estate Analysis Package* performs property income analysis, calculates after-tax results if sold or exchanged, highlights tax sheltering effects, simulates inflation, and enables you to know when to buy, hold, or dispose of property. It allows up to 20-year projections and utilizes the Rule of 78's, ACRS Depreciation Methods, and multiple and/or assumable loans. A must for investors, tax advisors, and accountants.

Price: \$274.95 suggested retail  
Includes user's manual and a diskette.

Author: Execuware™

Available:  
Computer retail stores

Name: **Super-Text™ 40/56/70**

System: Apple II  
Memory: 48K  
Language: Machine language  
Hardware: Disk drive

Description: You can choose a 40-, 56-, or 70-column screen display without any additional hardware. *Super-Text* gives you the best features in word processing for easy text handling all the way through. It introduces the *Character Designer* for creative special display characters and includes *Autolink*, the file-linking system for one-step search and replace or print functions.

Price: \$125.00

Includes tutorial documentation, quick reference card, and dual disk back-up.

Author: Ed Zaron

Available:  
Muse Software  
347 N. Charles St.  
Baltimore, MD 21201  
or computer stores

Name: **T/MAKER III**

System: Apple II, IBM PC, Osborn, NorthStar, or any system offering CP/M

Memory: 48K minimum  
Description: *T/MAKER III* uses a unique visual syntax to facilitate easy yet powerful word processing/text editing, list management/tabulation, spreadsheet/scientific calculations, load/unload data, and many other functions.

Price: \$275.00 retail  
Includes software, manual, and tutorial/quick reference booklet.

Author: Peter Roizen

Available:  
TMAKER  
1742 Willow Rd.  
Suite 206  
Palo Alto, CA 94304  
(415) 326-6103  
Call or write for distributor information

Name: **Mind Beggles-1**

System: Atari 400/800  
Memory: 16K - cassette  
24K - disk

Hardware: Disk drive or cassette recorder

Description: Three thought-

provoking mind bogglers are *Capture* — a strategy game in which you and the computer fight for control of the board (based on *Othello*); *Mystery Box* — a game in which you shoot rays into the mystery box to find the hidden atoms; and *Simon Says* — a memory teaser in which you must repeat the computer's pattern. The game adapts to the player's skill level.

Price: \$15.95 - cassette

\$19.95 - disk  
Includes cassette or diskette and user's guide.

Available:  
Versa Computing, Inc.  
3541 Old Conejo Rd.  
Suite 104  
Newbury Park, CA 91320  
(805) 498-1956

Name: **PTD-6502**

System: Apple II, Apple II Plus

Memory: 16K minimum  
Language: 6502 machine language

Hardware: Autostart ROM for fast breakpoint

Description: This BASIC-like compiled language debugs 6502 machine language and is relocatable. Nearly all commands can be executed in immediate mode or as part of a program with line numbers. Check on complex compound conditions at 1000 instructions/second, then see the 128 executed instructions prior to the condition.

Price: \$49.95

Includes relocater source code.

Author: Edwin Rosenzweig  
Harlan Harrison

Available:  
Pterodactyl Software  
1452 Portland Ave.  
Albany, CA 94706

Name: **El Diablero**

System: Radio Shack Color Computer

Memory: 16K  
Language: Assembly language

Hardware: Disk or cassette  
Description: *El Diablero* is an adventure game extraordinaire! You wake, dazed and confused, in the middle of a southwestern desert. You had been learning the techniques of sorcery from an old man who told you that an evil sorcerer, a diablero, was his enemy. Now your teacher is missing and you are alone. You can't seem to remember the techniques you learned except

the curious verse....

Price: \$19.95 - cassette

\$24.95 - disk  
plus \$2.00 S/H  
Includes cassette or disk and instructions.

Author: Kenneth Kalish

Available:  
Computerware  
Box 668  
Encinitas, CA 92024  
(714) 436-3512

Name: **The Big Math Attack**

System: Apple II Plus, Atari

Memory: 48K - Apple II  
16K - Atari  
cassette

24K - Atari disk  
Language: Applesoft, Atari BASIC

Description: This program skillfully combines the excitement and challenge of an arcade game with basic math skills of addition, subtraction, multiplication, and division. An equation is launched from a spaceship. The player must enter the correct answer before the equation lands on the city. Grades one to six.

Price: \$25.00 disk  
\$20.00 Atari cassette

Author: Schreiber & Schreiber

Available:  
T.H.E.S.I.S.  
P.O. Box 147  
Garden City, MI 48135-0147  
or from dealers

Name: **Alphabet Squares**

System: Apple II

Memory: 48K

Hardware: Disk drive

Description: An ideal program for the young computer user learning the ABC's. Excellent hi-res color graphics present three familiar objects: A is for airplane, B is for bird, etc. You use the joystick or paddles to move a pointer graphic from the letter to the correct picture. If correct, the graphic will expand to full screen as a reward. An exciting program for that young user who would like to use the computer too.

Price: \$29.95

Includes floppy diskette, user guide.

Available:  
Versa Computing, Inc.  
Suite 104  
3541 Old Conejo Rd.,  
Newbury Park, CA 91320  
(805) 498-1956

*(Continued)*

# Software Catalog *(continued)*

**Name:** **Market Time**  
**System:** CP/M, Apple Z80 card, IBM PC, Osborne 1, etc.  
**Memory:** 34K  
**Language:** A Compiled BASIC  
**Hardware:** Requires Cursor Control and two disk drives

**Description:** *Market Time*, an easy-to-use menu-driven program, provides a data base of selected market statistics that can be analyzed with moving averages and plotted on screen or printer to spot market turning points. It also features an expandable data base to allow entering additional market statistics of the user's choice.  
**Price:** \$75.00

Includes program disk, data file disk, and user's manual in three-ring binder.  
**Available:**  
 Hourglass Systems  
 P.O. Box 312,  
 Glen Ellyn, IL 60137  
 (312) 690-1855

**Name:** **AAARRRGGG!!!**  
**System:** Atari 400/800  
**Memory:** 16K - cassette  
 32K - disk  
**Language:** Hybrid  
**Description:** The fabric of space has been weakened by atomic bomb testing! Strange little creatures are popping through from another dimension, cluttering up the Earth. You have to catch as many as you can before your time runs out. Act quickly though, because the highest point-value creatures disappear the fastest. If you can catch the "SUPER AAARRRGGG," you'll get bonus time and super bonus points, but don't get poisoned by the glowing green radioactive creatures!  
**Price:** \$18.95 plus \$2.00 S/H  
**Author:** Bob Retelle

**Available:**  
 Pretzelland Software  
 2005 Whittaker Rd.  
 Ypsilanti, MI 48197  
 (313) 483-7358  
 or local dealers

**Name:** **Shuttle Intercept**  
**System:** Apple II  
**Memory:** 48K  
**Language:** Applesoft  
**Hardware:** One disk drive and a game paddle

**Description:** *Shuttle Intercept* takes you on a daring rescue mission into deep space. Your spacecraft is directed to retrieve friendly satellites bearing vital data and must fight or avoid enemy craft, satellites, missiles, and meteors.  
**Price:** \$34.95  
**Author:** John Van Ryzin  
**Available:**  
 The Hayden Software Co.  
 600 Suffolk Street  
 Lowell, MA 01853

**Name:** **Fast Figure**  
**System:** CP/M, Apple, Z80, IBM PC, Wang MYP, DECmate, Prime Microdata, Osborne 1, NorthStar  
**Memory:** 54K  
**Language:** A compiled BASIC  
**Hardware:** Cursor control, two disk drives, and Z80 card

**Description:** *Fast Figure*, a new electronic spreadsheet program with helping menus, offers sophisticated business calculations such as depreciation, present value and net present value, internal rate of return, compound growth, standard deviation, and what-if analysis in a package any business can easily afford. *Fast Figure's* three-dimensional file-sharing feature lets the user create additional multiple spreadsheets from one file without time consuming re-entry of data.

**Price:** \$150.00  
 Includes program disk and user's manual.  
**Available:**  
 Hourglass Systems  
 P.O. Box 312  
 Glen Ellyn, IL 60137  
 (312) 690-1855

**Name:** **Pot 'O Gold**  
**System:** Apple II Plus  
**Memory:** 48K  
**Language:** Applesoft  
**Hardware:** Disk drive, DOS 3.3, and paddles  
**Description:** *Pot 'O Gold* is a medley of 46 games that includes such classics as *Eliza*, *Color Math*, *Keyboard Organ*,

*Othello*, *Dragon Maze*, *Hex-pawn*, and *Pinball*. With the Echo II speech synthesizer, text appearing on the screen will have a voice accompaniment.  
**Price:** \$39.95  
**Author:** Jim Day  
**Available:**  
 Rainbow Computing Inc.  
 19517 Business Center Dr.  
 Northridge, CA 91324  
 (213) 349-0300

**Name:** **Modula-2**  
**System:** Apple II, Apple III, Z80/8080, TI9900  
**Memory:** 64K  
**Language:** Modula 2, Apple Pascal, UCSD Pascal Version 2.0

**Description:** The *Modula-2* language, designed by Pascal's creator Niklaus Wirth, provides a simple but powerful alternative for systems programming in assembly language, Pascal, C, and ADA. Features include modules, processes, separate compilation, dynamic array parameters, and low-level machine access.

**Price:** \$550.00  
 Includes compiler, librarian, run-time library, and interpreter.  
**Available:**  
 Volition Systems  
 P.O. Box 1236  
 Del Mar, CA 92014  
 (714) 481-2286

**Name:** **TransFORTH**  
**System:** Apple II or Apple II Plus (Apple III version sold separately)  
**Memory:** 48K  
**Language:** Machine language  
**Hardware:** DOS 3.3, one or more disk drives

**Description:** *TransFORTH* is a compiled programming language similar to FORTH that features floating-point capability and scientific functions, DOS 3.3 compatibility, versatile array structures, extensibility, and structured interactive programming.

**Price:** \$125.00  
 Includes disk and manual.  
**Author:** Paul Lutus  
**Available:**  
 Insoft, Inc.  
 10175 S.W. Barbur Blvd.  
 Suite 202B  
 Portland, OR 97219

**Name:** **The Filer**  
**System:** Apple II, Apple II Plus  
**Memory:** 48K  
**Language:** 6502 Assembly  
**Hardware:** DOS 3.3, one or more disk drives

**Description:** This is a general utility system for the Apple. Features include FAST copy program, disk speed and check, copy, delete, lock, unlock files, change booting program, and a catalog with space on the disk.

**Price:** \$19.95  
 Includes one disk with instructions.  
**Available:**  
 Central Point Software, Inc.  
 P.O. Box 19730-203  
 Portland, OR 97219

**Name:** **Darkstar™**  
**System:** Timex-Sinclair 1000 (ZX81), Apple II, Atari 800/400  
**Memory:** 16K RAM/Sinclair 48K RAM/Apple II and Atari  
**Language:** BASIC  
**Hardware:** Standard cassette tape deck — Sinclair Disk drive with DOS 3.3 — Apple 810 disk drive or 410 recorder — Atari

**Description:** This program solves problems associated with the photographic darkroom. It provides exposure times needed for changes to magnification, lens opening, and print density for both black-and-white and color materials, for both chromogenic or dye-bleach materials. It provides color-printing filter-pack checking and correcting for color balance, neutral density, and filter factors, and development times for black-and-white films over a wide temperature range, as a function of the user's ideal processing time at 68°F. Expert-type program.

**Price:** \$99.95/Sinclair tape \$129.95/Apple/Atari disk \$129.95/Atari tape  
 Includes 34 pages of documentation.  
**Author:** Bob Nadler  
**Available:**  
 F/22 Press  
 P.O. Box 141  
 Leonia, NJ 07605

**MICRO**

# SoftSide™

## Looking For Quality Software?

### READ THIS:

If the high price of commercial software and the lack of clear information about your microcomputer has got you down, here's the solution you've been waiting for!

### SoftSide Magazine

**SoftSide** is a favorite of computer users and hobbyists alike. They rely on it as a prime source of programs, reviews and articles for the Apple™, ATARI®, and TRS-80® microcomputers.

**SoftSide** is the magazine for the microcomputer owner who wants to learn BASIC programming, learn MORE about BASIC programming, or just wants to have FUN!

**SoftSide** gives you the BASIC code listings of several programs — adventures, utilities, games, simulations, you name it — for your computer EVERY MONTH.

#### There's more:

- **Reviews** — of the software and hardware products you want to know about.
- **Articles** — about all aspects of BASIC programming.
- **Tutorials** — on graphics, use of important commands, and more.
- **Programs** — each month **SoftSide** publishes a variety of program for the Apple, ATARI® and TRS-80®.



- **Columns** — which discuss different topics including: computer graphics, picking the right modem for you and marketing your software — just to name a few.
- **Input from our readers** — each month we devote a space in the magazine to let our readers give us some feedback about **SoftSide**.
- **Hints & Enhancements** — programmers and readers provide us with enhancements, to our programs, and programming tips.

Use coupon to order. Mail to: **SoftSide** Publications, 6 South St., Milford, NH 03055

**As you can see, you'll receive pages and pages of information and entertainment from SoftSide. Here's the best part:**

**A subscription to SoftSide is just \$24 a year. That's 12 issues for only \$2 each! What a value!**

**YES! Send me the first copy of my SoftSide subscription right away!**

\$24/yr for USA and Canada only. For orders to APO/FPO or Mexico — \$40/yr. Other foreign orders — \$62/yr.

I own a  Apple  ATARI®  TRS-80®

Name \_\_\_\_\_  
Address \_\_\_\_\_  
City/State \_\_\_\_\_ Zip \_\_\_\_\_

Check is enclosed  
 MasterCard  VISA

Name of Cardholder \_\_\_\_\_  
MC# and Interbank#/VISA# \_\_\_\_\_  
Exp. Date \_\_\_\_\_  
Signature \_\_\_\_\_

# MICRO<sup>TM</sup>

## Hardware Catalog

Name: **VC-PLUS**  
**80-column**

System: Apple II  
Memory: 48K  
Hardware: Legend 128K or  
64K RAM  
expansion card(s)

Description: Add memory to Personal Software's 16-sector VisiCalc program using Legend memory cards and the new VC-PLUS with 80-column capability. Your Apple II can have more power than an Apple III at a fraction of the cost.

Price: Free with purchase of RAM card.  
\$20.00 as an update.  
Includes diskette and operation manual.

Available:  
Legend Industries, Ltd.  
2220 Scott Lake Rd.  
Pontiac, MI 48054  
(313) 674-0953

Name: **Kraft Precision Joystick**

System: Apple II, IBM PC, TRS-80 Color Computer

Description: *Kraft Precision Joystick* features instantly selectable spring-centering or free-floating stick modes at the flip of a switch. High-quality potentiometers ensure greater linearity and better stick performance. Full one-year warranty.

Price: \$64.95 - \$69.95

Available:  
Contact Kraft Systems for name of nearest dealer  
(714) 724-7146

Name: **MAC INKER**

Description: *MAC INKER* automatically re-inks ribbons for any printer at an average cost of five cents per ribbon. Operation is simple. The ink contains a special lubricant that helps improve the life of the print-head.

Price: \$54.95  
Includes one two-ounce ink bottle (approximately six months of intensive use).

Available:  
Computer Friends  
100 North West 86th Ave.  
Portland, OR 97229  
(503) 297-3231

Name: **6522 Parallel I/O Card**

System: Commodore  
VIC-20

Language: BASIC or assembly language

Description: This card is designed to plug directly into the VIC's expansion port. It provides two programmable 8-bit ports with expanded handshake capability that allow the user to interface any parallel peripheral device to the VIC-20. It also includes two 16-bit programmable timer/counters and a serial data port. The on-board switch-selectable address feature allows the alteration of the card's memory location within the system and provides for the use of multiple cards when an expansion chassis is utilized.

Price: \$69.95 — assembled  
and tested  
\$59.95 — kit  
Includes the user guide and application notes.

Available:  
Fountain Intelligent Devices Company  
P.O. Box 913  
Palo Alto, CA 94302  
OEM and dealer inquiries welcome

Name: **DISKBUB**

Description: *DISKBUB* is a compact bubble-memory board with 128K bytes of data storage. It will interface to the FLEX<sup>TM</sup> operating system using a 68XX-based micro-processor with a 30-pin ss 50 I/O bus. *DISKBUB* acts like a disk but has the advantages of bubble memory, high reliability data storage, and operation in harsh environments. *DISKBUB* can be used to boot up systems, replacing the need for disks altogether. Its applications include process control, automation, data logging, and robotics. It can be used virtually anywhere a computer must withstand a harsh environment.

Price: \$995.00

Available:  
Universal Data Research Inc.  
2457 Wehrle Drive  
Buffalo, NY 14221

Name: **EPROM Pack**

System: TRS-80 Color Computer

Memory: 4K and up  
Language: BASIC or Extended BASIC

Description: The *EPROM Pack* is a plug-in cartridge for the Color Computer that allows up to 16K bytes of user ROM to be added simply and quickly to the machine. Four sockets are contained in the pack to allow 2732-type EPROMs to be inserted. Additional programs, like assemblers, word processors, graphics, and games can be permanently available to the computer.

Price: \$39.95  
Includes EPROM Pack cartridge and full instructions.

Available:  
Maple Leaf Systems  
Box 2190, Station "C"  
Downsview, Ontario,  
Canada M2N 2S9

Name: **Atari Bank Select Memory**

System: Atari 400  
Memory: 64K

Description: The board consists of 48K RAM with four banks of 4K RAM addressed above the 48K limit to insure that the 48K is continuous and 52K RAM is always available. It also means a ROM cartridge will never affect the availability of the bank select RAM. The 4K RAM banks allow for a larger hard-wired RAM size and all Atari software and peripherals are compatible.

Price: \$249.95 suggested retail

Available:  
Mosaic Electronics  
P.O. Box 708  
Oregon City, OR 97045  
(800) 547-2708

Name: **Computer Case**

System: Commodore 64

Description: CM703 holds the Commodore 64 computer, one or two 1541 disk drives, power supply, and other equipment. CM704 holds the Commodore 64 computer and dataset program recorder (plus other equipment). These cases provide portability and a convenient method of storage, free

from possible damage and dust accumulation. The computer and software are protected from tampering and unauthorized use by replacing and locking the lid.

Price: \$119.00 - CM703  
\$109.00 - CM704

Available:  
Computer Case Company  
5650 Indian Mound Court  
Columbus, OH 43213  
(800) 848-7548  
Or most computer stores

Name: **NOVADAPTER**

Description: *NOVADAPTER* consists of two 25-pin D-connectors, 25 short wires with pins crimped-on, some B-crimps, and a hood. Using the short wires you can wire between the pin positions and create the cable connection quickly. Ideal for extension cables, gender changers, and null modems. It replaces all existing cables with 25-pin D-connectors.

Price: \$30.00

Available:  
Innovative Supplies & Accessories Inc.  
P.O. Box 61149  
Dallas, TX 75261  
(214) 641-8090

Name: **ROM Simulator**

Description: This is a new fast-responding ROM simulator that is capable of emulating virtually any ROM, programmable ROM, or erasable PROM. The simulator occupies one card slot of any IEEE standard S100 bus computer. The P&E board also simulates memory-response time for experimenting with various timing possibilities. When not in use as a simulator, the board can function as additional RAM for the micro-processor or as an I/O port-driven memory extension unit.

Price: \$600.00  
Includes 2K RAM and complete manual.

Available:  
P&E Microcomputer Systems, Inc.  
P.O. Box 2044  
Woburn, MA 01880  
(617) 944-7585



## Hardware Catalog *(continued)*

**Name:** PET Joystick Interface  
**System:** PET/CBM  
**Description:** This versatile interface card adds joystick/paddle capabilities to all PET/CBM computers. The device enables the PET to accept input directly from two Apple joysticks, four Apple game paddles, or two Atari joysticks. The interface is complete and ready to plug into the user port. All modes of operation are software-selectable. The device features short access time [less than 10 milliseconds/joystick] and high-resolution digitization [greater than 8 bits]. Fast machine-language input routines, callable from a BASIC program, are included.  
**Price:** \$49.95  
Includes interface card, power supply, documentation, and sample software.  
**Available:**  
] Systems Corp.  
1 Edmund Place  
Ann Arbor, MI 48103  
(313) 662-4714

**Name:** The Spectrum Stick  
**System:** Color Computer  
**Memory:** 4K-64K  
**Language:** Microsoft BASIC  
**Hardware:** Joystick  
**Description:** *The Spectrum Stick* has the following features: hair trigger firebutton, swivel ball-type component joystick to give you a smooth and true feel, red LED power indicator to remind you to shut off the Color Computer after the TV, brush-aluminum knob, and extra-long cable.  
**Price:** \$39.95 plus \$2.00 S/H  
Includes joystick, firebutton, case, and cable.  
**Available:**  
Spectrum Projects  
93-1586 Drive  
Woodhaven, NY 11421  
(212) 441-2807

**Name:** RS-232 Expansion Cable  
**System:** Color Computer  
**Memory:** 4K and up  
**Hardware:** "Y" cable  
**Description:** The RS-232 Expansion Cable allows two devices to be connected to the serial I/O port at the same time. A printer and modem can be hooked in-line without constantly swapping cables.  
**Price:** \$19.95 plus \$1.00 S/H

**Available:**  
Spectrum Projects  
93-1586 Drive  
Woodhaven, NY 11421  
(212) 441-2807 Voice  
(212) 441-3755 Computer

**Name:** BUSMAN  
**System:** Commodore PET/CBM  
**Description:** BUSMAN provides dual IEEE-488 busses; one for "local" peripherals used exclusively by the installed system; the other allows multiple BUSMANs to be networked together to share "common" peripherals. It maintains the stand-alone ability of Commodore systems plus networking.  
**Price:** \$595.00 each  
**Available:**  
Lem Data Products  
P.O. Box 1080  
Columbia, MD 21044

**Name:** MULTIPORT™  
**System:** TRS-80 Color Computer  
**Memory:** 4K-32K  
**Language:** BASIC  
**Description:** The MULTIPORT is a hardware device containing four sockets that allow Color Computer peripherals (disks, program cartridges, I/O cards, etc.) to be on-line at all times and selectable under software control.  
**Price:** \$99.50  
Includes fully assembled and tested MULTIPORT and documentation.  
**Available:**  
Maple Leaf Systems  
P.O. Box 2190, Station "C"  
Downsview, Ontario  
Canada M2N 2S9

**Name:** SYSTEM 200™  
**System:** Apple II, Apple III, IBM PC, etc.  
**Description:** These modular, solid-oak units feature contemporary design with unique disk storage capabilities allowing random selection of any disk by label. The units house disk drives, manuals, monitor, and accessories as well. All the units function individually or collectively with available add-on modules in user-customized configurations.  
**Price:** From \$31.95 to \$279.95 per module, FOB shipping point  
Includes Floppy Fingers™ diskette holders, Floppy

Drawers™ diskette filing system, The Bridge™ hardware organizer.  
**Available:**  
Venice Woodworking Co.  
12810 Venice Boulevard  
Los Angeles, CA 90066  
(213) 390-4885

**Name:** RS-232 Expansion  
**System:** Color Computer  
**Memory:** 4K and up  
**Hardware:** "Y" cable  
**Description:** The RS-232 Expansion Cable allows two devices to be connected to the serial I/O port at the same time. A printer and modem can be hooked in-line without constantly swapping cables.  
**Price:** \$19.95 plus \$1.00 S/H  
**Available:**  
Spectrum Projects  
93-1586 Drive  
Woodhaven, NY 11421  
(212) 441-2807 Voice  
(212) 441-3755 Computer

**Name:** ALIS  
**Instrumentation Modules**  
**System:** 48K Apple II or Apple II Plus  
**Memory:** 2.5K RAM maximum  
**Language:** 6502 Machine and Applesoft RAM or ROM  
**Hardware:** Disk drive, printer optional  
**Description:** The ALIS family of data acquisition and control modules for an Apple II computer provides an economical multi-function laboratory or industrial instrumentation system. Hardware and augmented BASIC software permit 8- or 12-bit analog input/output, and multi-function digital I/O at rates up to 10K Hz under ALIS software control. The digital module provides 32 bidirectional lines, 2 16-bit hardware clocks, and up to 14 serviceable interrupt conditions.  
**Price:** \$1149.00 8-bit analog input  
\$1517.00 12-bit analog input  
\$1787 Digital I/O  
\$613.00 - \$991.00 Analog output  
Includes PC card(s), cables, terminal box, AMPERALIS and real time graphics software on diskette, and manual.  
**Available:**  
Eco-Tech, Inc.  
2990 Lake Lansing Rd.  
P.O. Box 776  
East Lansing, MI 48823  
(517) 337-9226

**Name:** Executive Compu-Cover  
**System:** All microcomputers  
**Description:** The Executive Compu-Cover is an attractive, high-quality leatherette cover for computers, disk drives, monitors, printers, and other peripheral equipment. These covers will prevent dust and foreign matter from entering and damaging equipment when not in use.  
**Price:** \$14.95 ppd. - Apple II  
Other prices on request.  
**Available:**  
Executive Compu-Cover  
76-51 169 Street  
Queens, NY 11366  
(212) 969-1079

**Name:** Apple-Verter  
**Model APX 800**  
**System:** Apple II  
**Description:** This plug-in video to RF modulator for Apple II operates in high VHF band (Ch. 7-10), tunable. It attaches inside the Apple II w/VELCRO, then plugs into an existing video/power connector. The die-cast aluminum housing executes frequency stability with no assembly needed. Built-in 5V regulator allows use with other computer systems.  
**Price:** \$29.75  
**Available:**  
ATV Research or local dealers

**Name:** BUBBLE™  
**System:** APPLE II  
**Memory:** 128K Bubble memory  
**Hardware:** Intel 7110  
**Language:** DOS 3.3 with patches for Pascal and CP/M  
128K Non-volatile memory with on-board boot prom eliminates disk and operates in any environment. It is three to four times faster and 1000 times more reliable than Floppy. Bubble boots directly from the module or operates in conjunction with disk system.  
**Price:** \$875.00  
Includes software for DOS 3.3 emulation and boot prom.  
**Available:**  
MPC Peripherals Corporation  
9424 Chesapeake Drive  
San Diego, CA. 92123  
or your local Computerland Store

**ACRO**



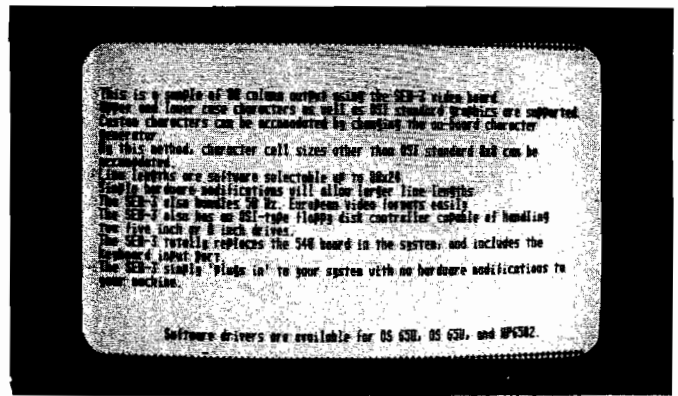
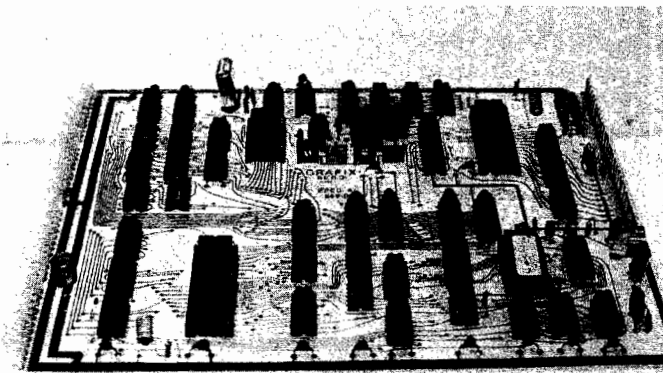

# SUPER OSI EXPANSION BOARDS

Tired of trying to run your word processor or your DMB on an OSI 64 character video screen? Now there's the SEB-3, THE most versatile 80x24 video board anywhere is available for OSI 48 pin BUSS systems. No longer will you have to consider converting your video-based system to a serial terminal because you've found 64 characters stifling for serious business use. Nor need you give up compatibility with any existing graphics software because the SEB-3 allows you to choose ANY screen format up to 80x24 including 32x32 and 64x32. Since the SEB-3's screen format can be changed at any time under software control, even gaming displays can benefit from screens custom tailored to the game itself. The SEB-3 is so well designed and so versatile that it will not need to be replaced — ever. Simple changes in software and/or hardware will allow the SEB-3 to: generate displays up to 256

columns; handle 50 Hz European formats; accommodate custom characters or character cell sizes larger or smaller than 8x8 and transparently access the screen to eliminate screen "glitches". In short, the SEB-3 will meet any demands your system may place on it now and in the future. The SEB-3 also supports an OSI-style floppy disk interface which can handle two 5" or 8" drives. Like all of the boards in the SEB series, the SEB-3 simply "plugs in" to your machine — there are absolutely NO hardware changes. The SEB-3 is designed to replace your outmoded 540 board so you don't even lose a backplane slot. Your keyboard input now also plugs into the SEB-3 — load one of the software drivers and you're ready to go!

**SEB-3 Assembled \$259.00**  
**Kit \$220.00**

**Bare Board \$59.00**  
**Manual only \$5.00**

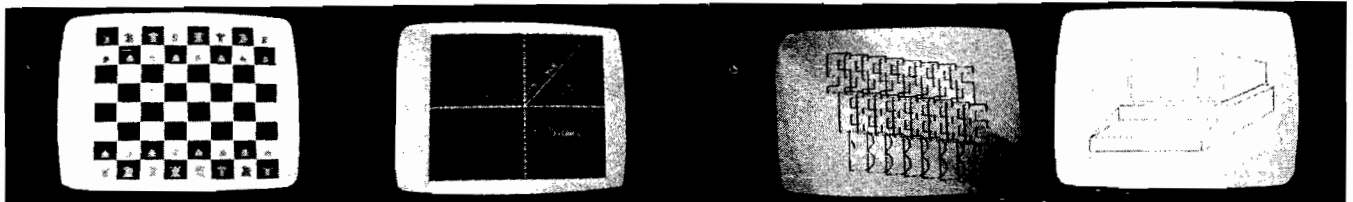

If your Challenger can't generate displays like those shown above **WHAT ARE YOU WAITING FOR?** The SEB-1 High Resolution Graphics and Memory Board (for C1P and Superboard II) and the SEB-2 High Resolution Graphics and Disk Controller Board (for C2/4/8) simply 'plug-in' to your computer and give you instant access to over 49000 individually addressable pixels in up to 8 colors! Your Hi-Res screen can go from 32 x 16 alphanumerics to 256 x 192 point graphics in 11 software selectable modes. The standard video of your computer is left intact, so that none of your current software library is outmoded. Use the graphics for Business, Scientific, Education, or Gaming displays that were impossible — until now!

Installation of either board requires absolutely NO modification of your computer—they just 'plug-in'. Nor do they preclude your using any other OSI-compatible hardware or software. In addition to the Hi-Res Graphics the SEB-1 gives C1 & Superboard II users 16K of additional user memory (over and above that memory devoted to the graphics), two 16 bit timers/counters, an on-board RF modulator, and a parallel port with handshaking. The SEB-2 gives OSI 48-pin BUS users an OSI hardware/software compatible Disk controller, and an RF modulator that can be user-populated.

**FOR OSI 1P, 2-4P, 2-8P, C4P, C8P**

	SEB-1	SEB-2
<b>Assembled and Tested</b>	<b>\$249.00 (5K RAM)</b>	<b>\$239.00 (1K RAM)</b>
<b>Kit</b>	<b>\$165.00 (No RAM)</b>	<b>\$199.00 (No RAM)</b>

	SEB-1	SEB-2
<b>Bare Board &amp; Manual</b>	<b>\$ 59.00</b>	<b>\$ 59.00</b>
<b>Manual only</b>	<b>\$ 5.00</b>	<b>\$ 5.00</b>

COMING: SEB-3 80x24 Video/Disk Controller (C2/4/8), SEB-4 48K Memory RAM/ROM (C2/4/8), SEB-5 8K RAM/Disk/Sound/Clock/Voice (C1 & Superboard).

Write for **FREE** catalog  
International Requests please  
supply 2 International Response Coupons

**ORION**



**SOFTWARE ASSOC.**

P.O. BOX 310, OSSINING, NY 10562



914-762-5636

## 6809 Bibliography

### 93. Color Computer News (August, 1982)

- Lester, Lane P., "Mileage Monitor," pg. 40-42.  
An automotive program for the Color Computer.
- Bogan, John R., "Digits," pg. 44-45.  
Mix alphanumerics with your graphics programs with this program for the Color Computer.
- Phelps, Andrew, "Comment Corner," pg. 46-48.  
Documentation of the "get next character" routine of the TRS-80 Color Computer.
- Sullivan, Steve, "Venus Lander," pg. 49-54.  
A game for the 6809-based Color Computer.
- Hawks, Christopher R., "Homebrew 64K Conversion," pg. 57-58.  
A hardware article for TRS-80 Color Computer users.
- Hogg, Frank, "64K Korner," pg. 59-60.  
Miscellaneous notes on memory assignments in the 6809-based TRS-80 Color Computer.
- Rothstein, Mark, "On Modifying Packaged ROM Programs," pg. 61-64.  
Notes on ROM program modification including a listing for an "Automated Address Modification Program" for the Color Computer.
- Giovanoni, Richard, "Learning Curves — A Real Life Use of Microcomputers in Aerospace," pg. 65-76.  
A Color Computer curve graphics program. Listing and examples.
- Hornsby, James A., "Justprin," pg. 77-83.  
A word-processing program featuring proportional spacing for the Color Computer.
- Hunt, Craig, "Air Raid," pg. 86-91.  
A graphics game for the 6809-based Color Computer.

### 94. MICRO, No. 52 (September, 1982)

- Clark, Hal, "6809 Macros for Structured Programming," pg. 57-63.  
This article presents a technique for using 6809 assembler macros to allow structured assembly-language programming.
- Suckle, Leonard I., "Market Projection Program for the Color Computer," pg. 67-77.  
A sophisticated business program implemented on the 6809-based TRS-80 Color Computer.
- Staff, "MICRO Reviews in Brief," pg. 103-106.  
Reviews include several pieces of software for the 6809 user.
- Dial, Wm. R., "6809 Bibliography," pg. 110.  
Some 32 references to the 6809 literature are cited.
- Staff, "MICRO Software Catalog," pg. 111-116.  
Several software programs for 6809-related equipment are cited.
- Staff, "MICRO Hardware Catalog," pg. 117.  
Hardware for 6809 systems are listed.

### 95. 80-U.S. Journal, 5, No. 9 (September, 1982)

- Tangeman, Richard, "Color Computer Assembler/Disassembler," pg. 38-45.  
Get inside your 6809E-based Color Computer with this utility.
- Davis, Lynn, "Three Color Computer Video Tips," pg. 96-97.  
Several listings for the TRS-80 Color Computer involving switching PMODEs for effect.

### 96. '68' Micro Journal, 4, Issue 9 (September, 1982)

- Anderson, Ronald W., "FLEX User Notes," pg. 8-11.  
Notes on addition and subtraction routines with 6809 FLEX.

Notes on FORTH, Pascal, "C", BASIC, and assembler languages.

- Nay, Robert L., "Color User Notes," pg. 11-12.  
Notes of interest to TRS-80 Color Computer users.
- Distefano, Tony, "Color Clinic," pg. 13-14.  
A hardware modification to alter the background color on the 6809-based Color Computer.
- Commo, Norm, "'C' User Notes," pg. 14-18.  
Discussion of initialization code for the 'C' user.
- Urie, Paul M., "Telecon C," pg. 18-20.  
Discussion of new utilities for 6809 systems. Includes some benchmark tests.
- Zeff, Robert, "Simple Winchester Interface," pg. 20-21.  
Hardware and procedure for implementing a Winchester hard disk on 6809 systems.
- Pass, E.M., "6800 to 6809," pg. 24-26.  
Converting 6800 assembler language to 5809 assembler language.
- Watson, Ernest Steve, "Home Accounting Program," pg. 26-28.  
Part III reads in from a data file information concerning the proposed budget.
- Williams, Don, "Structured Assembler/Translate Subroutines," pg. 36-38.  
Macros and subroutines based on the 6809 assembler.

### 97. Dr. Dobb's Journal 7, Issue 9 (September, 1982)

- Donner, George C., "68XX Blurp," pg. 7.  
A users' group is forming for those interested in the 6809 microprocessor, the OS-9 operating system, and UNIX-like systems on 68xx machines.

### 98. PET Benelux Exchange 3, No. 2 (July, 1982)

- Anon., "SuperPET and 8096," pg. 3 (insert).  
Short note on the 6809-based SuperPET.

### 99. BYTE 7, No. 9 (September, 1982)

- Stuart, John, "Three Dee Tee," pg. 34-50.  
A computer game for the 6809-based TRS-80 Color Computer based on Rubik's Cube and Tic Tac Toe.
- Staff, "Software Received," pg. 494-496.  
Reviews a couple of programs for the 6809-based systems.

### 100. Compute! 4, No. 9 (September, 1982)

- Chastain, Linton S., "TRS-80 Color Computer Energy Monitor Graphics," pg. 130-131.  
A companion program for the 'Energy Monitor' program cited earlier.

### 101. 80 Micro (October, 1982)

- Calle, Carlos, "Personal Finance," pg. 38.  
A finance program for the Color Computer.
- Norman, Scott L., "Newtalk," pg. 38-39.  
A utility for those doing machine-language or assembly-language programming on a 6800 or 6809 system.
- Stone, Stephen G., III, "Color Scripsit."  
Word processing for the TRS-80 Color Computer.
- Barden, William, Jr., "The Color Computer on Parade — Part I," pg. 82-87.  
All about graphics on the 6809-based Color Computer.
- Stark, Peter A., "Income Tax Estimator," pg. 168-182.  
Use your 6809-based Color Computer for the IRS.

# In The Beginning Was The Word...

# MICROCOMPUTING<sup>®</sup>

October 1982  
USA \$2.95 (UK£2.00)  
Number 70

A WAYNE GREEN PUBLICATION

## Discover Sp Matchless

### MICROCOCCLUS•MICROLITER

**micrococcus**, mi kro kok' us, n. a microscopic organism of a round form.

**Microcomputing**, mi' kro kom put ing, n. (Gr. mikros, small, and L. computo, to calculate.) The multi-system monthly journal for computer enthusiasts, containing all the information needed to turn your microcomputer into a powerful machine. Includes dozens of new programs, articles on innovative computer applications, buyer's guides, new programming techniques, accurate reviews of hardware and software, complete coverage of new products, tips on your system's hidden capabilities, hardware modifications, tutorials, utilities, book reviews, industry news. Plus features on computers in business, science, education and games. Written in understandable language by experts in the field of computing. Special emphasis is placed on the Apple, Atari, Commodore, Heath and IBM systems, but not to the exclusion of other systems.

(Ed. note—A one year subscription to MICROCOMPUTING is only \$24.97. Call

**1-800-258-5473**

Or send in the coupon below.)

**microcopy**, mi' kro kop i, n. A photographic copy of printed material or photographs...

## MICROCOMPUTING<sup>®</sup>

**The First Word in Computer Publishing.**

\*Apple<sup>®</sup> is a registered trademark of Apple Computer, Inc.

YES! I want to get the First Word in Computer Publishing. Send me 12 issues of MICROCOMPUTING for only \$24.97.

Check enclosed  MC  VISA  AE  Bill me

731 RMC

Card# \_\_\_\_\_ Exp. Date \_\_\_\_\_

Interbank# \_\_\_\_\_

Name \_\_\_\_\_

Address \_\_\_\_\_

City \_\_\_\_\_ State \_\_\_\_\_ Zip \_\_\_\_\_

**MICROCOMPUTING<sup>®</sup>**

Box 997  
Farmingdale, NY 11737

Canada & Mexico \$27.97, 1 Year Only, U.S. Funds  
Foreign Surface \$44.97, 1 Year Only, U.S. Funds Drawn on U.S. Bank  
Allow 6-8 weeks for delivery.

# TRS-80C

## TRS-80C Data Sheet #12

TRS-80® Color Computer, 6809E-based computer, manufactured by Radio Shack,® a division of Tandy Corporation.

TRS-80C comes standard with 4K RAM, color BASIC-in-ROM, cassette, and serial interface. RS options include expansion to 16K RAM, joysticks, cassette recorder, printer, disk system. Additional options available are expansion to 64K, FLEX, and OS-9 operating systems. Standard screen output to TV; may be modified for use with monitor.

### RS232C PRINTER VARIABLES

Variable	Hex Address	Dec. Address	Hex Value	Dec. Value	Quant.
Baud Rate	95	149	01CA	1-202	120 Baud
			00BE	0-180	300 Baud
			0057	0-87	600 Baud
			0029	0-41	1200 Baud
			0012	0-18	2400 Baud
Line Delay	97	151	0001	0-1	None
			4000	64-0	.288 Sec.
			8000	128-0	.576 Sec.
			FFFF	255-255	1.15 Sec.
Line Width	9B	155	10	16	16 Char/Line
			20	32	"
			40	64	"
			84	132	"
			FF	255	"
Comma Field Width	99	153	10	16	16
Last Comma Field	9A	154	70	112	112

Decimal	Hex	Memory Contents
0-255	0-FF	Direct page RAM
256-273	100-111	Interrupt Vector's
274-276	112-114	USRJMP — Jump to BASIC's USR routine
278-279	116-117	RND Function SEED
282	11A	Keyboard Alpha lock — 0 = not locked, FF = locked
283-284	11B-11C	Keyboard delay constant
285-337	11D-151	BASIC token directory
338-345	152-159	Keyboard rollover table
346-349	15A-15D	Joystick pot values
350-425	15E-1A9	System Jump vectors
426-1023	1AA-3FF	I/O Buffers
1024-1535	400-5FF	Video display
1536-4095	600-0FFF	Program and variable storage (4K RAM)
1536-16383	600-3FFF	Program and variable storage (16K RAM)
1536-32767	600-7FFF	Program and variable storage (32K RAM)
32768-40959	8000-9FFF	Extended Color BASIC
40960-49151	A000-BFFF	COLOR BASIC (8K ROM)
49152-65279	C000-FFFF	Program Pak Memory
65280-65535	FF00-FFFF	Input/Output

### MEMORY MAP

#### RS232C Interface Pinout

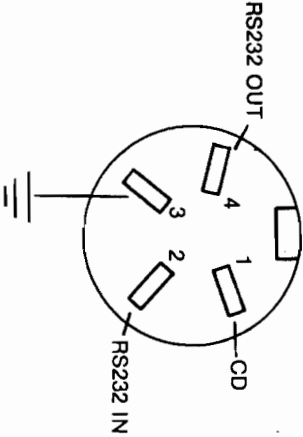

#### Cassette Interface Pinout

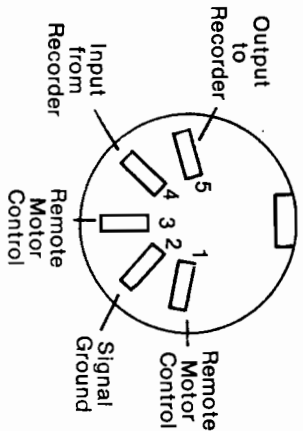

High Logic (Logic 1) voltage greater than +3 volts  
Low Logic (Logic 0) voltage less than -3 volts

It is assumed that: the printer generates a busy output when not ready. The printer automatically will carriage return at the end of a line. The data format is 1 Start Bit (Logic 0), 2 Stop Bits (Logic 1), 7 Data Bits (LSB First), and No Parity Bit.

# TRS-80C

## TRS-80C MICRO Data Sheet #12

Decimal	Hex	Inverse Screen	Keyboard	Hex	Keyboard	Normal Screen	Hex	Keyboard	Hex	Screen	BASIC	Hex	Screen	Hex	Screen	Decimal	Hex	Graphic Screen	Hex	Decimal	Hex	6809	
0	00	@	Space	40	@	@	80	FOR	128	GREEN	INT	192	GREEN	C0	192	SUBA #	6809	192	192	192	192	SUBA #	6809
1	01	A	Space	41	#A	A	81	GO	129	GREEN	ABS	193	GREEN	C1	193	CMPA #	6809	193	193	193	193	CMPA #	6809
2	02	B	Space	42	#B	B	82	REM	130	GREEN	USR	194	GREEN	C2	194	SBCA #	6809	194	194	194	194	SBCA #	6809
3	03	C	Space	43	#C	C	83	"	131	GREEN	RND	195	GREEN	C3	195	SUBD #	6809	195	195	195	195	SUBD #	6809
4	04	D	Space	44	#D	D	84	ELSE	132	GREEN	SIN	196	GREEN	C4	196	ANDA #	6809	196	196	196	196	ANDA #	6809
5	05	E	Space	45	#E	E	85	IF	133	GREEN	PEEK	197	GREEN	C5	197	BITA #	6809	197	197	197	197	BITA #	6809
6	06	F	Space	46	#F	F	86	DATA	134	GREEN	LEN	198	GREEN	C6	198	LDA #	6809	198	198	198	198	LDA #	6809
7	07	G	Space	47	#G	G	87	PRINT	135	GREEN	STR\$	199	GREEN	C7	199	---	6809	199	199	199	199	---	6809
8	08	H	Space	48	#H	H	88	ON	136	GREEN	VAL	200	GREEN	C8	200	EORA #	6809	200	200	200	200	EORA #	6809
9	09	I	Space	49	#I	I	89	INPUT	137	GREEN	ASC	201	GREEN	C9	201	ADCA #	6809	201	201	201	201	ADCA #	6809
10	0A	J	Space	4A	#J	J	8A	END	138	GREEN	CHR\$	202	GREEN	CA	202	ORA #	6809	202	202	202	202	ORA #	6809
11	0B	K	Space	4B	#K	K	8B	NEXT	139	GREEN	EOF	203	GREEN	CB	203	ADDA #	6809	203	203	203	203	ADDA #	6809
12	0C	L	Space	4C	#L	L	8C	DIM	140	GREEN	JOYSTK	204	GREEN	CC	204	CMX #	6809	204	204	204	204	CMX #	6809
13	0D	M	Space	4D	#M	M	8D	READ	141	GREEN	LEFT\$	205	GREEN	CD	205	ADD #	6809	205	205	205	205	ADD #	6809
14	0E	N	Space	4E	#N	N	8E	RUN	142	GREEN	RIGHT\$	206	GREEN	CE	206	LDX #	6809	206	206	206	206	LDX #	6809
15	0F	O	Space	4F	#O	O	8F	RESTORE	143	GREEN	MID\$	207	GREEN	CF	207	---	6809	207	207	207	207	---	6809
16	10	P	Space	50	#P	P	90	RETURN	144	GREEN	POINT	208	GREEN	D0	208	SUBA D	6809	208	208	208	208	SUBA D	6809
17	11	Q	Space	51	#Q	Q	91	STOP	145	GREEN	INKEY\$	209	GREEN	D1	209	CMPA D	6809	209	209	209	209	CMPA D	6809
18	12	R	Space	52	#R	R	92	POKE	146	GREEN	MEM	210	GREEN	D2	210	SBCA D	6809	210	210	210	210	SBCA D	6809
19	13	S	Space	53	#S	S	93	CONT	147	GREEN	---	211	GREEN	D3	211	SBCB D	6809	211	211	211	211	SBCB D	6809
20	14	T	Space	54	#T	T	94	LIST	148	GREEN	---	212	GREEN	D4	212	ADDD D	6809	212	212	212	212	ADDD D	6809
21	15	U	Space	55	#U	U	95	CLEAR	149	GREEN	---	213	GREEN	D5	213	BITB D	6809	213	213	213	213	BITB D	6809
22	16	V	Space	56	#V	V	96	NEW	150	GREEN	---	214	GREEN	D6	214	LDB D	6809	214	214	214	214	LDB D	6809
23	17	W	Space	57	#W	W	97	CLOAD	151	GREEN	---	215	GREEN	D7	215	STB D	6809	215	215	215	215	STB D	6809
24	18	X	Space	58	#X	X	98	CSAVE	152	GREEN	---	216	GREEN	D8	216	EORB D	6809	216	216	216	216	EORB D	6809
25	19	Y	Space	59	#Y	Y	99	OPEN	153	GREEN	---	217	GREEN	D9	217	ADCB D	6809	217	217	217	217	ADCB D	6809
26	1A	Z	Space	5A	#Z	Z	9A	CLOSE	154	GREEN	---	218	GREEN	DA	218	ORB D	6809	218	218	218	218	ORB D	6809
27	1B	[	Space	5B	#[	[	9B	LLIST	155	GREEN	---	219	GREEN	DB	219	ADDD D	6809	219	219	219	219	ADDD D	6809
28	1C	\	Space	5C	#\	\	9C	SET	156	GREEN	---	220	GREEN	DC	220	DD D	6809	220	220	220	220	DD D	6809
29	1D	]	Space	5D	#]	]	9D	RESET	157	GREEN	---	221	GREEN	DD	221	STDD	6809	221	221	221	221	STDD	6809
30	1E	^	Space	5E	#^	^	9E	CLS	158	GREEN	---	222	GREEN	DE	222	LDUD	6809	222	222	222	222	LDUD	6809
31	1F	~	Space	5F	#~	~	9F	MOTOR	159	GREEN	---	223	GREEN	DF	223	STU D	6809	223	223	223	223	STU D	6809
32	20	Space	Space	60	Space	Space	A0	SOUND	160	GREEN	---	224	GREEN	E0	224	SUBA	6809	224	224	224	224	SUBA	6809
33	21	1	Space	61	A	A	A1	AUDIO	161	GREEN	---	225	GREEN	E1	225	CMPA	6809	225	225	225	225	CMPA	6809
34	22	2	Space	62	B	B	A2	EXEC	162	GREEN	---	226	GREEN	E2	226	SBCA	6809	226	226	226	226	SBCA	6809
35	23	3	Space	63	C	C	A3	SKIPF	163	GREEN	---	227	GREEN	E3	227	SUBD	6809	227	227	227	227	SUBD	6809
36	24	4	Space	64	D	D	A4	TAB	164	GREEN	---	228	GREEN	E4	228	ANDA	6809	228	228	228	228	ANDA	6809
37	25	5	Space	65	E	E	A5	TO	165	GREEN	---	229	GREEN	E5	229	BITA	6809	229	229	229	229	BITA	6809
38	26	6	Space	66	F	F	A6	SUB	166	GREEN	---	230	GREEN	E6	230	LDA	6809	230	230	230	230	LDA	6809
39	27	7	Space	67	G	G	A7	THEN	167	GREEN	---	231	GREEN	E7	231	STA	6809	231	231	231	231	STA	6809
40	28	8	Space	68	H	H	A8	NOT	168	GREEN	---	232	GREEN	E8	232	EORA	6809	232	232	232	232	EORA	6809
41	29	9	Space	69	I	I	A9	STEP	169	GREEN	---	233	GREEN	E9	233	ADCA	6809	233	233	233	233	ADCA	6809
42	2A	0	Space	6A	J	J	AA	OFF	170	GREEN	---	234	GREEN	EA	234	ORA	6809	234	234	234	234	ORA	6809
43	2B	1	Space	6B	K	K	AB	+	171	GREEN	---	235	GREEN	EB	235	ADDA	6809	235	235	235	235	ADDA	6809
44	2C	2	Space	6C	L	L	AC	*	172	GREEN	---	236	GREEN	EC	236	CMPX	6809	236	236	236	236	CMPX	6809
45	2D	3	Space	6D	M	M	AD	^	173	GREEN	---	237	GREEN	ED	237	JSR	6809	237	237	237	237	JSR	6809
46	2E	4	Space	6E	N	N	AE	/	174	GREEN	---	238	GREEN	EE	238	LDX	6809	238	238	238	238	LDX	6809
47	2F	5	Space	6F	O	O	AF	↑	175	GREEN	---	239	GREEN	EF	239	STX	6809	239	239	239	239	STX	6809
48	30	6	Space	70	P	P	B0	AND	176	GREEN	---	240	GREEN	F0	240	SUBB E	6809	240	240	240	240	SUBB E	6809
49	31	7	Space	71	Q	Q	B1	OR	177	GREEN	---	241	GREEN	F1	241	CMPB E	6809	241	241	241	241	CMPB E	6809
50	32	8	Space	72	R	R	B2	>	178	GREEN	---	242	GREEN	F2	242	SBCB E	6809	242	242	242	242	SBCB E	6809
51	33	9	Space	73	S	S	B3	=	179	GREEN	---	243	GREEN	F3	243	ADDD E	6809	243	243	243	243	ADDD E	6809
52	34	0	Space	74	T	T	B4	<	180	GREEN	---	244	GREEN	F4	244	ANDB E	6809	244	244	244	244	ANDB E	6809
53	35	1	Space	75	U	U	B5	↓	181	GREEN	---	245	GREEN	F5	245	BITB E	6809	245	245	245	245	BITB E	6809
54	36	2	Space	76	V	V	B6	←	182	GREEN	---	246	GREEN	F6	246	LDB E	6809	246	246	246	246	LDB E	6809
55	37	3	Space	77	W	W	B7	→	183	GREEN	---	247	GREEN	F7	247	STB E	6809	247	247	247	247	STB E	6809
56	38	4	Space	78	X	X	B8	←	184	GREEN	---	248	GREEN	F8	248	EORB E	6809	248	248	248	248	EORB E	6809
57	39	5	Space	79	Y	Y	B9	→	185	GREEN	---	249	GREEN	F9	249	ADCB E	6809	249	249	249	249	ADCB E	6809
58	3A	6	Space	7A	Z	Z	BA	←	186	GREEN	---	250	GREEN	FA	250	ORB E	6809	250	250	250	250	ORB E	6809
59	3B	7	Space	7B	[	[	BB	→	187	GREEN	---	251	GREEN	FB	251	ADDD E	6809	251	251	251	251	ADDD E	6809
60	3C	8	Space	7C	\	\	BC	←	188	GREEN	---	252	GREEN	FC	252	ANDB E	6809	252	252	252	252	ANDB E	6809
61	3D	9	Space	7D	]	]	BD	→	189	GREEN	---	253	GREEN	FD	253	LDX E	6809	253	253	253	253	LDX E	6809
62	3E	0	Space	7E	~	~	BE	←	190	GREEN	---	254	GREEN	FE	254	STX E	6809	254	254	254	254	STX E	6809
63	3F	1	Space	7F	Space	Space	BF	→	191	GREEN	---	255	GREEN	FF	255	---	6809	255	255	255	255	---	6809

6809 COLUMN  
 I = INHERENT  
 # = IMMEDIATE  
 D = DIRECT  
 E = EXTENDED  
 R = RELATIVE  
 . = INDEXED  
 KEYBOARD  
 # = SHIFT

# NATIONAL ADVERTISING REPRESENTATIVES

## WEST COAST

The R.W. Walker Co., Inc.  
**Gordon Carnie**  
2716 Ocean Park Boulevard  
Suite 1010  
Santa Monica, California 90405  
(213) 450-9001

*serving: Washington, Oregon, Idaho, Montana, Wyoming, Colorado, New Mexico, Arizona, Utah, Nevada, California, Alaska, and Hawaii (also British Columbia and Alberta, Canada).*

## MID-WEST TERRITORY

Thomas Knorr & Associates  
**Thomas H. Knorr, Jr.**  
333 N. Michigan Avenue  
Suite 707  
Chicago, Illinois 60601  
(312) 726-2633

*serving: Ohio, Oklahoma, Arkansas, Texas, North Dakota, South Dakota, Nebraska, Kansas, Missouri, Indiana, Illinois, Iowa, Michigan, Wisconsin, and Minnesota.*

## MIDDLE ATLANTIC AND SOUTHEASTERN STATES

Dick Busch Inc. <b>Richard V. Busch</b> 6 Douglass Dr., R.D. #4 Princeton, NJ 08540 (201) 329-2424	Dick Busch, Inc. <b>Eleanor M. Angone</b> 74 Brookline E. Atlantic Beach, NY 11561 (516) 432-1955
--	---

*serving: New York, Pennsylvania, New Jersey, Delaware, Maryland, West Virginia, Virginia, D.C., North Carolina, South Carolina, Louisiana, Tennessee, Mississippi, Alabama, Georgia, and Florida.*

## NEW ENGLAND

**Kevin B. Rushalko**  
Peterboro, New Hampshire 03458  
(603) 547-2970

*serving: Maine, New Hampshire, Vermont, Massachusetts, Rhode Island, Connecticut, and Kentucky.*

## ADVERTISING MANAGER

**Cathi Bland**

address materials directly to:  
MICRO INK, Advertising  
34 Chelmsford Street  
Chelmsford, Massachusetts 01824  
(617) 256-5515

## Advertiser's Index

Aardvark Technical Services, Ltd.	68
ABC Data Products	79
Anthro-Digital Software	24
Apex Co.	62
Appletree Electronics	17
Ark Computing	20
Artsci, Inc.	IFC
CGRS Microtech	54
Chameleon Computing	18
Commander Micro Systems Specialties	53
Compu \$ense	10
CompuTech	74
Computer Mail Order	56-57
Computer Science Engineering	90
Datamost, Inc.	34, 91
Digicom Engineering, Inc.	53
Digital Acoustics	14
D&N Micro Products, Inc.	88
Eastern House Software	12
Elcomp	98
Excert, Inc.	44
Execom Corp.	70
Gimix, Inc.	1
Gooth Software	29
Hudson Digital Electronics Inc.	75
Human Systems Dynamics	29
Interesting Software	16
John Bell Engineering	4
Leading Edge	BC
Logical Devices	62
Lyc0 Computing	27
MICRObits (Classifieds)	77
MICRO INK	8, 18, 93, IBC
Microcomputing	108
Micro Signal	13
Micro-Ware Distributing Inc.	42
Modular Mining Systems	9
Modular Systems	79
Nibble	55
Orion Software	106
Perry Peripherals	61
Power Processing	63
Privac, Inc.	33
Pterodactyl Software	37
Skyles Electric Works	2
Softronics	6
Softside Publications	58, 103
Software Options	80
Spectrum Systems	80
Star Micronics	30
Universal Data Research	70
XPS, Inc.	67

MICRO INK is not responsible for claims made by its advertisers. Any complaint should be submitted directly to the advertiser. Please also send written notification to MICRO.



# Next Month in MICRO

## February: Language Feature

- **APPLE Pascal Hi-Res Screen Dump** — Use this high-resolution graphics dump to send APPLE Pascal Turtlegraphics to an Epson printer with Grafrax.
- **APL on the SuperPET**— APL offers powerful features, high execution speeds, and a cryptic character set. This article discusses APL's history and advantages, with specific reference to the Waterloo version on the SuperPET.
- **Parameter Passing in Assembly Language** — The author describes various methods for passing parameters to and from assembly-language programs. The Motorola 6502, 6809, 68000, and National Semiconductor 16032 are emphasized.
- **EDIT: A FORTH Screen-Oriented Editor** — EDIT uses the Atari 800 display as a text window into a FORTH disk screen and allows full use of the Atari special function keys to prepare FORTH applications.

## Plus...

FORTH for the 6809  
LISP for the APPLE  
OSI PROM BASIC  
IEEE Control with Logical Files on the PET  
OSI Renummer BASIC  
Applesoft BASIC Routine for CAI

## Columns

APPLE Slices  
PET Vet  
From Here to ATARI  
CoCo Bits

## Departments

Reviews in Brief  
Software and Hardware Catalogs  
New Publications  
FORTH Data Sheet

# 20% OFF

**Your money goes farther when you subscribe.** During the course of a year, when you subscribe, you save 20% (in the U.S.).

Pay only \$24.00 (\$2.00 a copy) for 12 monthly issues of MICRO sent directly to your home or office in the U.S.

## More MICRO for Less Money When You Subscribe

But on the newsstand — if you can locate the issue you want — you pay \$30.00 a year (\$2.50 a copy).

**Special Offer** — Subscribe for 2 years (\$42.00) and get 30% off the single issue price.

Subscribe to MICRO today.

**MICRO**  
34 Chelmsford Street  
P.O. Box 6502  
Chelmsford, MA 01824

Please send me MICRO for  1 year  2 years  
NOTE: Airmail subscriptions accepted for 1 year only.

Check enclosed \$ \_\_\_\_\_  
Charge my \_\_\_\_\_ VISA account  
\_\_\_\_\_ Mastercard account

No. \_\_\_\_\_

Expiration date \_\_\_\_\_

Name \_\_\_\_\_

Address \_\_\_\_\_

City/State \_\_\_\_\_ Zip \_\_\_\_\_

## Subscription Rates Effective January 1, 1982

Country	Rate
United States	\$24.00 1 yr. 42.00 2 yr.
Foreign surface mail	27.00
Europe (air)	42.00
Mexico, Central America, Mid East, N. & C. Africa	48.00
South Am., S. Afr., Far East, Australasia, New Zealand	72.00

\* Airmail subscriptions accepted for only 1 year.  
For U.S. and Canadian 2-year rates, multiply by 2.

Job Title: \_\_\_\_\_

Type of Business/Industry: \_\_\_\_\_

**Don't Miss  
A Single Issue**

**MICRO**

*Advancing Computer Knowledge*

**Subscribe Today!**

**Stay on the Forefront of the**

**Revolution in Computer Knowledge**

**Complete Postage-Paid Card  
and Mail Today**

# THE PROWRITER COMETH.

*(And It Cometh On Like Gangbusters.)*

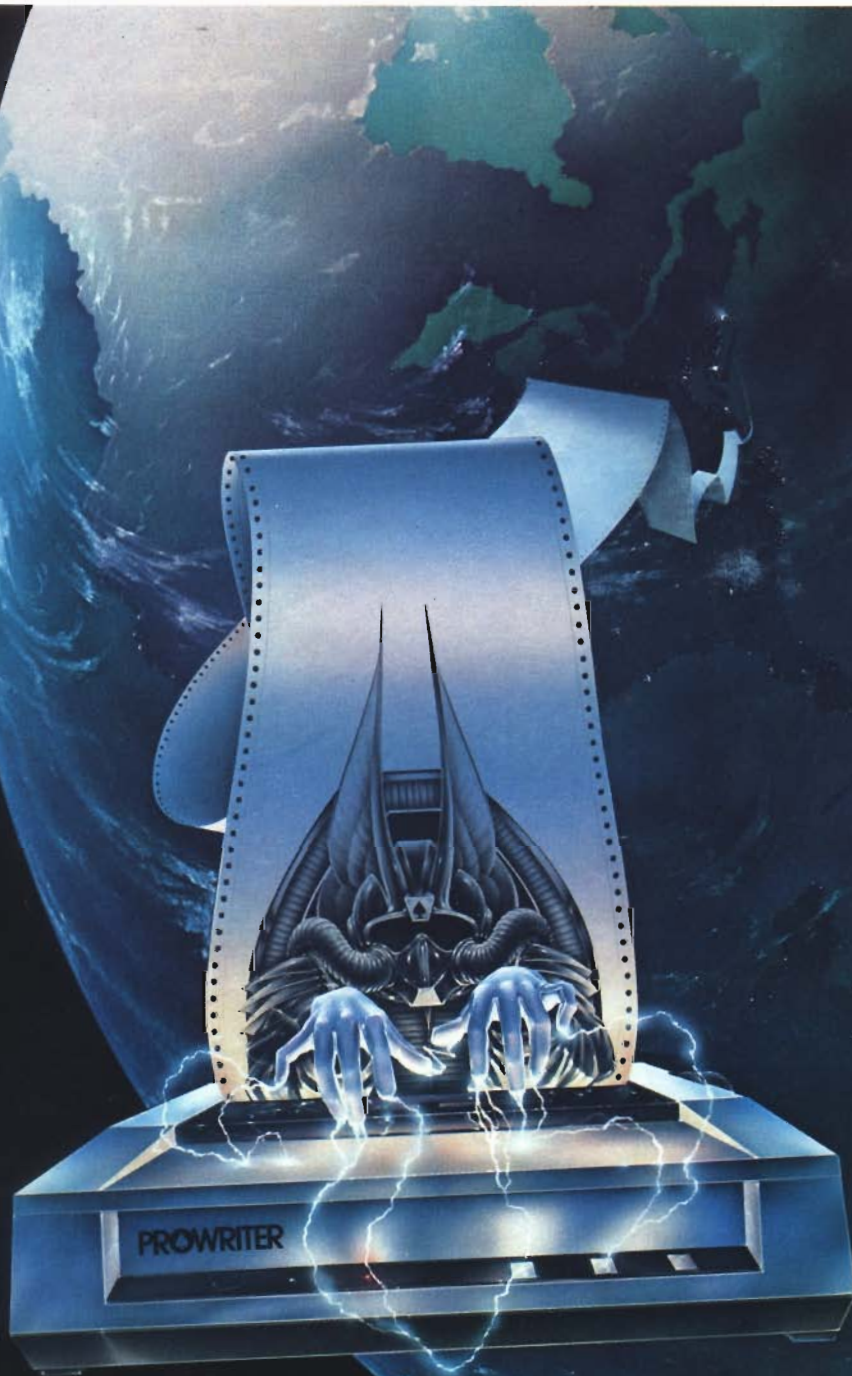

Evolution.

It's inevitable. An eternal verity.

Just when you think you've got it knocked, and you're resting on your laurels, somebody comes along and makes a dinosaur out of you.

Witness what happened to the Centronics printer when the Epson MX-80 came along in 1981.

And now, witness what's happening to the MX-80 as the ProWriter cometh to be the foremost printer of the decade.

## **SPEED**

MX-80: 80 cps, for 46 full lines per minute throughput.

PROWRITER: 120 cps, for 63 full lines per minute throughput.

## **GRAPHICS**

MX-80: Block graphics standard, fine for things like bar graphs.

PROWRITER: High-resolution graphics features, fine for bar graphs, smooth curves, thin lines, intricate details, etc.

## **PRINTING**

MX-80: Dot matrix business quality.

PROWRITER: Dot matrix correspondence quality, with incremental printing capability standard.

## **FEED**

MX-80: Tractor feed standard; optional friction-feed kit for about \$75 extra.

PROWRITER: Both tractor and friction feed standard.

## **INTERFACE**

MX-80: Parallel interface standard; optional serial interface for about \$75 extra.

PROWRITER: Available standard—either parallel interface or parallel/serial interface.

## **WARRANTY**

MX-80: 90 days, from Epson.

PROWRITER: One full year, from Leading Edge.

## **PRICE**

Heh, heh.

*Marketed Exclusively by Leading Edge Products, Inc., 225 Turnpike Street, Canton, Massachusetts 02021. Call: toll-free 1-800-343-6833; or in Massachusetts call collect (617) 828-8150. Telex 951-624.*

## **LEADING EDGE<sup>®</sup>**

*For a free poster of "Ace" (Prowriter's pilot) doing his thing, please write us.*

# Model Rocket Simulation in BASIC

by David Eagle

**This article describes a program to determine the altitude performance of single-stage model rockets, including burnout conditions, flight time, and maximum altitude of a model rocket.**

**ROCKET1**  
requires:  
**BASIC**

ROCKET1 solves the problem of vertical model rocket motion by using several assumptions that allow the equation of motion to be solved exactly or analytically. These assumptions involve the boost phase of flight where an average thrust and average model rocket mass are assumed. The atmospheric density and drag coefficient are also assumed to be constant during the entire model rocket flight. ROCKET1 also compensates for non-standard launch sites that are not at sea level and launchings on hot or cold days.

## User Inputs and Selections

ROCKET1 will prompt the user for the necessary inputs. A description of these requests and a discussion of how the user should respond follows. Information that pertains to the model rocket engine characteristics is available from manufacturers' catalogs.

### LAUNCH SITE ALTITUDE (METERS)?

The user responds with the altitude of the launch site relative to sea level. This altitude is input in meters and is positive for sites above sea level and negative for sites below sea level.

### LAUNCH SITE TEMPERATURE (DEG F)?

The user responds with the temperature at the launch site in decimal degrees Fahrenheit.

### THRUST DURATION (SECONDS)?

The user inputs the total thrust duration of the model rocket engine in seconds.

### TOTAL IMPULSE (NEWTON-SECONDS)?

The user responds with the total impulse of the model rocket engine in the units of newton-seconds.

### INITIAL MASS (GRAMS)?

The user inputs the lift-off or gross mass of the entire model rocket in grams.

### PROPELLANT MASS (GRAMS)?

The user responds with the propellant mass of the model rocket engine in grams.

### FRONTAL DIAMETER (MM)?

The user inputs the maximum body tube diameter of the model rocket in millimeters.

### DRAG COEFFICIENT?

The user responds with the drag co-

efficient of the complete model rocket. This number is non-dimensional.

After the program has run it will prompt the user for another selection. A description of each prompt follows. The user responds with "Y" if he/she desires the particular selection, or "N" if not.

### ANOTHER SELECTION (Y = YES, N = NO)?

The user responds with "N" to exit the program.

### ANOTHER LAUNCH SITE (Y = YES, N = NO)?

The user responds with "Y" to compute the model rocket flight performance at another launch site.

### ANOTHER ROCKET ENGINE (Y = YES, N = NO)?

The user responds with "Y" to compute a model rocket's flight performance with a different model rocket engine.

### DIFFERENT MASS OR DRAG (Y = YES, N = NO)?

## Sample Run

```

PROGRAM ROCKET1

LAUNCH SITE ALTITUDE (METERS)? 0
LAUNCH SITE TEMPERATURE (DEG F)? 59
THRUST DURATION (SECONDS)? 1.2
TOTAL IMPULSE (NEWTON-SECONDS)? 5
INITIAL MASS (GRAMS)? 40
PROPELLANT MASS (GRAMS)? 8.33
FRONTAL DIAMETER (MM)? 18
DRAG COEFFICIENT? .321

      BURNOUT ALTITUDE (METERS)           74.0671213
      BURNOUT VELOCITY (METERS/SECOND)    119.35939
      COAST TIME (SECONDS)                 7.93162468
      TOTAL FLIGHT TIME (SECONDS)         9.13162468
      MAXIMUM ALTITUDE (METERS)           451.393595
      ANOTHER SELECTION (Y=YES, N=NO)?

```