

TANDY®

Portable Disk Drive

OPERATION MANUAL

Cat. No. 26-3808

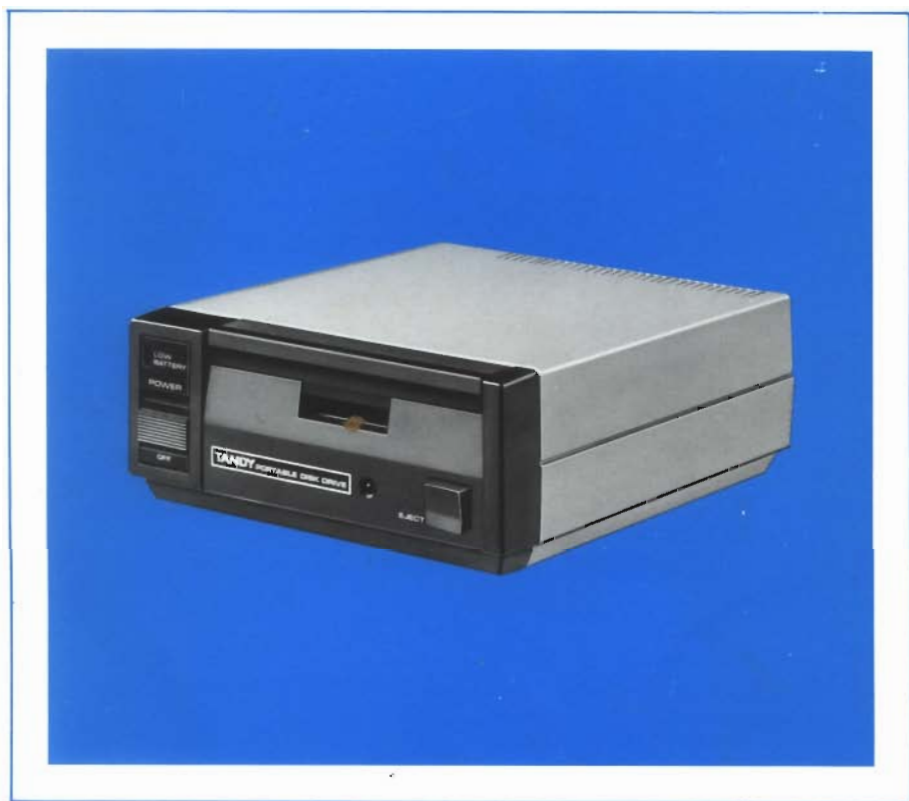

The FCC Wants You to Know

This equipment generates and uses radio frequency energy. If not installed and used properly, that is, in strict accordance with the manufacturer's instructions, it may cause interference to radio and television reception.

It has been type tested and found to comply with the limits for a Class B computing device in accordance with the specifications in Subpart J of Part 15 of FCC Rules, which are designed to provide reasonable protection against such interference in a residential installation. However, there is no guarantee that interference will not occur in a particular installation.

If this equipment does cause interference to radio or television reception, which can be determined by turning the equipment off and on, the user is encouraged to try to correct the interference by one or more of the following measures:

- Reorient the receiving antenna
- Relocate the computer with respect to the receiver
- Move the computer away from the receiver
- Plug the computer into a different outlet so that computer and receiver are on different branch circuits.

If necessary, you should consult the dealer or an experienced radio television technician for additional suggestions. You may find the following booklet prepared by the Federal Communications Commission helpful: *How to Identify and Resolve Radio-TV Interference Problems*.

This booklet is available from the US Government Printing Office, Washington DC 20402, Stock No. 004-000-00345-4.

Warning

This equipment has been certified to comply with the limits for a Class B computing device, pursuant to Subpart J of Part 15 of FCC Rules. Only peripherals (computer input/output devices, terminals, printers, etc.) certified to comply with the Class B limits may be attached to this computer. Operation with non-certified peripherals is likely to result in interference to radio and TV reception.

TERMS AND CONDITIONS OF SALE AND LICENSE OF TANDY COMPUTER EQUIPMENT AND SOFTWARE
PURCHASED FROM RADIO SHACK COMPANY-OWNED COMPUTER CENTERS, RETAIL STORES AND
RADIO SHACK FRANCHISEES OR DEALERS AT THEIR AUTHORIZED LOCATIONS

LIMITED WARRANTY

I. CUSTOMER OBLIGATIONS

- A. CUSTOMER assumes full responsibility that this computer hardware purchased (the "Equipment"), and any copies of software included with the Equipment or licensed separately (the "Software") meets the specifications, capacity, capabilities, versatility, and other requirements of CUSTOMER.
- B. CUSTOMER assumes full responsibility for the condition and effectiveness of the operating environment in which the Equipment and Software are to function, and for its installation.

II. LIMITED WARRANTIES AND CONDITIONS OF SALE

- A. For a period of ninety (90) calendar days from the date of the Radio Shack sales document received upon purchase of the Equipment, RADIO SHACK warrants to the original CUSTOMER that the Equipment and the medium upon which the Software is stored is free from manufacturing defects. **This warranty is only applicable to purchases of Tandy Equipment by the original customer from Radio Shack company-owned computer centers, retail stores, and Radio Shack franchisees and dealers at their authorized locations.** The warranty is void if the Equipment's case or cabinet has been opened, or if the Equipment or Software has been subjected to improper or abnormal use. If a manufacturing defect is discovered during the stated warranty period, the defective Equipment must be returned to a Radio Shack Computer Center, a Radio Shack retail store, a participating Radio Shack franchisee or a participating Radio Shack dealer for repair, along with a copy of the sales document or lease agreement. The original CUSTOMER'S sole and exclusive remedy in the event of a defect is limited to the correction of the defect by repair, replacement, or refund of the purchase price, at RADIO SHACK'S election and sole expense. RADIO SHACK has no obligation to replace or repair expendable items.
- B. RADIO SHACK makes no warranty as to the design, capability, capacity, or suitability for use of the Software, except as provided in this paragraph. Software is licensed on an "AS IS" basis, without warranty. The original CUSTOMER'S exclusive remedy, in the event of a Software manufacturing defect, is its repair or replacement within thirty (30) calendar days of the date of the Radio Shack sales document received upon license of the Software. The defective Software shall be returned to a Radio Shack Computer Center, a Radio Shack retail store, a participating Radio Shack franchisee or Radio Shack dealer along with the sales document.
- C. Except as provided herein no employee, agent, franchisee, dealer or other person is authorized to give any warranties of any nature on behalf of RADIO SHACK.
- D. **EXCEPT AS PROVIDED HEREIN, RADIO SHACK MAKES NO EXPRESS WARRANTIES, AND ANY IMPLIED WARRANTY OF MERCHANTABILITY OR FITNESS FOR A PARTICULAR PURPOSE IS LIMITED IN ITS DURATION TO THE DURATION OF THE WRITTEN LIMITED WARRANTIES SET FORTH HEREIN.**
- E. Some states do not allow limitations on how long an implied warranty lasts, so the above limitation(s) may not apply to CUSTOMER.

III. LIMITATION OF LIABILITY

- A. **EXCEPT AS PROVIDED HEREIN, RADIO SHACK SHALL HAVE NO LIABILITY OR RESPONSIBILITY TO CUSTOMER OR ANY OTHER PERSON OR ENTITY WITH RESPECT TO ANY LIABILITY, LOSS OR DAMAGE CAUSED OR ALLEGED TO BE CAUSED DIRECTLY OR INDIRECTLY BY "EQUIPMENT" OR "SOFTWARE" SOLD, LEASED, LICENSED OR FURNISHED BY RADIO SHACK, INCLUDING, BUT NOT LIMITED TO, ANY INTERRUPTION OF SERVICE, LOSS OF BUSINESS OR ANTICIPATORY PROFITS OR CONSEQUENTIAL DAMAGES RESULTING FROM THE USE OR OPERATION OF THE "EQUIPMENT" OR "SOFTWARE." IN NO EVENT SHALL RADIO SHACK BE LIABLE FOR LOSS OF PROFITS, OR ANY INDIRECT, SPECIAL, OR CONSEQUENTIAL DAMAGES ARISING OUT OF ANY BREACH OF THIS WARRANTY OR IN ANY MANNER ARISING OUT OF OR CONNECTED WITH THE SALE, LEASE, LICENSE, USE OR ANTICIPATED USE OF THE "EQUIPMENT" OR "SOFTWARE."**
NOTWITHSTANDING THE ABOVE LIMITATIONS AND WARRANTIES, RADIO SHACK'S LIABILITY HEREUNDER FOR DAMAGES INCURRED BY CUSTOMER OR OTHERS SHALL NOT EXCEED THE AMOUNT PAID BY CUSTOMER FOR THE PARTICULAR "EQUIPMENT" OR "SOFTWARE" INVOLVED.
- B. RADIO SHACK shall not be liable for any damages caused by delay in delivering or furnishing Equipment and/or Software.
- C. No action arising out of any claimed breach of this Warranty or transactions under this Warranty may be brought more than two (2) years after the cause of action has accrued or more than four (4) years after the date of the Radio Shack sales document for the Equipment or Software, whichever first occurs.
- D. Some states do not allow the limitation or exclusion of incidental or consequential damages, so the above limitation(s) or exclusion(s) may not apply to CUSTOMER.

IV. SOFTWARE LICENSE

RADIO SHACK grants to CUSTOMER a non-exclusive, paid-up license to use the TANDY Software on one computer, subject to the following provisions:

- A. Except as otherwise provided in this Software License, applicable copyright laws shall apply to the Software.
- B. Title to the medium on which the Software is recorded (cassette and/or diskette) or stored (ROM) is transferred to CUSTOMER, but not title to the Software.
- C. CUSTOMER may use Software on one host computer and access that Software through one or more terminals if the Software permits this function.
- D. CUSTOMER shall not use, make, manufacture, or reproduce copies of Software except for use on one computer and as is specifically provided in this Software License. Customer is expressly prohibited from disassembling the Software.
- E. CUSTOMER is permitted to make additional copies of the Software **only** for backup or archival purposes or if additional copies are required in the operation of one computer with the Software, but only to the extent the Software allows a backup copy to be made. However, for TRSDOS Software, CUSTOMER is permitted to make a limited number of additional copies for CUSTOMER'S own use.
- F. CUSTOMER may resell or distribute unmodified copies of the Software provided CUSTOMER has purchased one copy of the Software for each one sold or distributed. The provisions of this Software License shall also be applicable to third parties receiving copies of the Software from CUSTOMER.
- G. All copyright notices shall be retained on all copies of the Software.

V. APPLICABILITY OF WARRANTY

- A. The terms and conditions of this Warranty are applicable as between RADIO SHACK and CUSTOMER to either a sale of the Equipment and/or Software License to CUSTOMER or to a transaction whereby Radio Shack sells or conveys such Equipment to a third party for lease to CUSTOMER.
- B. The limitations of liability and Warranty provisions herein shall inure to the benefit of RADIO SHACK, the author, owner and/or licensor of the Software and any manufacturer of the Equipment sold by Radio Shack.

VI. STATE LAW RIGHTS

The warranties granted herein give the original CUSTOMER specific legal rights, and the original CUSTOMER may have other rights which vary from state to state.

Portable Disk Drive Operation Manual
Copyright 1985 Tandy Corporation
All Rights Reserved.

Reproduction or use, without express written permission from Tandy Corporation and/or its licensor, of any portion of this manual is prohibited. While reasonable efforts have been taken in the preparation of this manual to assure its accuracy, Tandy Corporation assumes no liability resulting from any errors or omissions in this manual, or from the use of the information contained herein.

Contents

Introduction	1
1 General information	3
Description of the Portable Disk Drive	3
Diskette	4
Installation	5
Connecting to the Portable Computer	5
Battery installation	5
Connecting the AC adapter (option)	6
System start-up	6
Setting the system disk	7
Loading the file management software	7
Setting the DIP switches of the Portable Disk Drive	9
2 File management	11
File management functions	11
File management start-up	11
Commands	13
Files	13
Load	13
Save	14
Bkup	16
Kill	18
Name	18
Format	19
Menu	20
3 Error messages	21
Appendices	
A Specifications	25
B Schematic diagram	27

Introduction

Congratulations on your purchase of the TANDY Portable Disk Drive.

Your Portable Disk Drive interfaces to your Portable Computer through the RS-232C port and may be powered by batteries for maximum portability. Its compactness and light weight enable you to carry it along with your Portable Computer. Although tiny in size, a 3.5-inch diskette can store up to 100,000 bytes of data.

Now you can utilize your Portable Computer to its greatest potential without worrying about a shortage of memory space.

General information 1

Description of the Portable Disk Drive

Open the package and take out the Portable Disk Drive. Do not throw away the packing material or the box. They may be useful if you ever need to transport the Portable Disk Drive.

The Portable Disk Drive package includes:

- a Portable Disk Drive
- a Utility Diskette
- a cable for connection to a Portable Computer

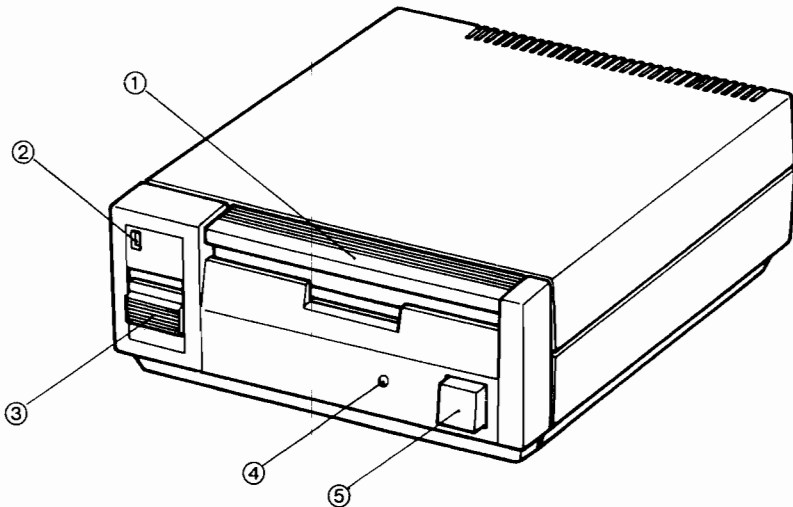

- ① Disk In/Out Bar
- ② Low Battery Indicator
- ③ Power Switch
- ④ Access Indicator
- ⑤ Eject Button

Figure 1

Diskette

Always handle your diskettes carefully. Take the same precautions you would use with your music cassettes and high-fidelity phonograph records. A small indentation, dust particle or scratch can render all or part of a diskette unreadable — permanently!

1. Always remove a diskette from the Drive before turning the system on or off. (Do not eject a diskette when the access indicator is lit.)
2. Keep diskettes away from magnetic fields (transformers, AC motors, TVs, radios, etc.). Strong magnetic fields will erase data stored on a diskette.
3. Handle a diskette with the shutter closed. (Refer to Figure 2 below.) Do not touch any of the exposed surfaces. Do not try to wipe or clean the diskette surface; it scratches very easily.
4. Keep diskettes out of direct sunlight and away from heat.
5. Avoid contaminating diskettes with cigarette ashes, dust or other particles.
6. In extremely dusty environments, you may need to provide filtered air to the room where you use your Portable Computer.

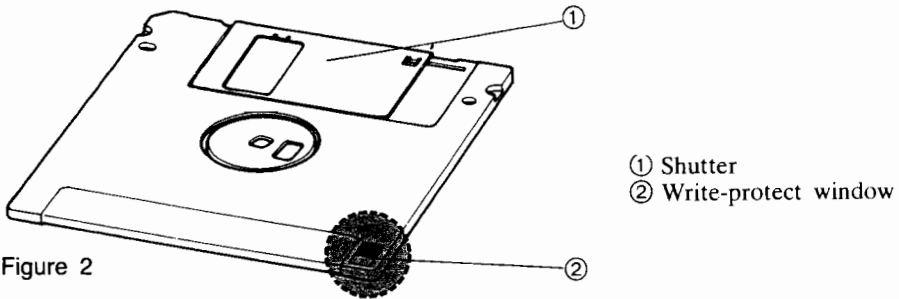
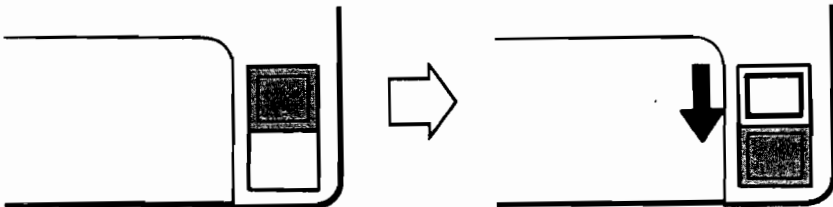

Figure 2



When the write-protect tab is positioned so that the window is closed, data can be written to the diskette.

Figure 3

When the tab is positioned so that the window is open, data is write-protected.

Figure 4

Installation

Connecting to the Portable Computer

Connect the Portable Computer and the Portable Disk Drive using the connection cable referred to in Figure 5. The larger connector plugs into the RS-232C port on the rear side of the Portable Computer; the smaller connector plugs into the RS-232C port on the rear side of the Portable Disk Drive. Both plugs are asymmetrical, so if a plug can't be inserted easily, don't force it. Just turn the plug over and try again. Be sure that the cable connections are secure. Loose connections will cause problems since data is transferred through this cable.

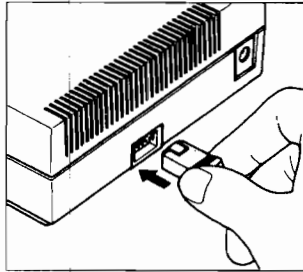

Figure 5

Battery installation

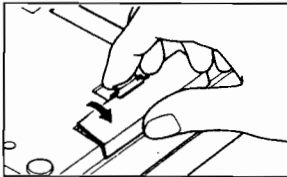

Figure 6

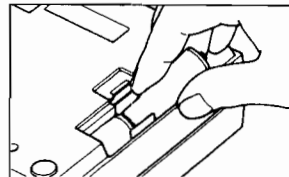

Figure 7

1. Press the tab as illustrated in Figure 6. Remove the battery compartment cover.
2. Insert four "AA" batteries. Be sure the batteries are set in the battery compartment as shown in Figure 7.
3. Replace the battery compartment cover.

General information

With four new alkaline batteries, the Portable Disk Drive can operate continuously for up to two full hours. When the low battery indicator lights up, you should still have approximately 30 minutes of continuous operating time left. No operation will occur if the batteries are too low; in fact, the low battery indicator will not even light up.

Notes:

- A) When the batteries become weak, the low battery indicator will light up. When this happens, replace all four batteries with new ones. We recommend our 23-552 alkaline batteries.
- B) Turn off the power switch when the unit is not being used. If the unit will not be used for a long time, or if the AC adapter is to be used for an extended period of time, remove the batteries to avoid damaging fluid leakage.
(Be aware that even commercially available batteries which are guaranteed may sometimes leak.)

Connecting the AC adapter (option)

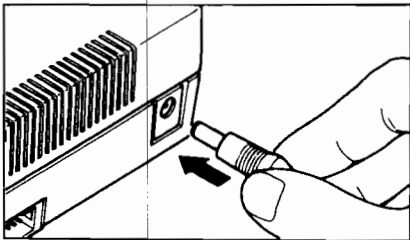

Figure 8

Connect the AC adapter (Cat. No. 26-3804) to the DC6V jack, and then plug the adapter into a wall outlet.

Notes:

- A) Use only the 26-3804 AC adapter.
 - B) The batteries will be automatically disconnected from the power supply circuit when the AC adapter is connected.
- C) If the unit will not be used for a long period of time, disconnect the AC adapter from both the wall outlet and this unit's jack.
 - D) Don't connect and disconnect the AC adapter while the disk is inserted in the unit.

System start-up

Be sure that the cable connections are secure and that the batteries have been installed or the AC adapter has been connected according to the instructions in the **Installation** section.

If you are ready, start-up the Portable Disk Drive by following the procedure below.

Note: This software cannot be used with any Portable Computer operating in conjunction with the Disk/Video Interface (Cat. No. 26-3806).

Setting the system disk

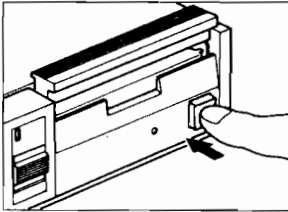

Figure 9

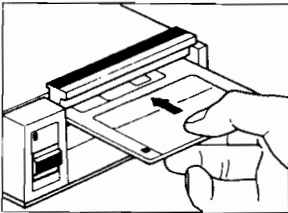

Figure 10

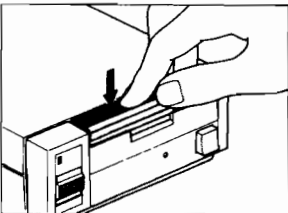

Figure 11

1. Power-up your Portable Disk Drive and your Portable Computer.
2. Push the eject button.

3. Insert the utility disk (that was provided) with the labelside up, as shown in Figure 10.

Notes:

- A) Use only a 3.5-inch floppy disk.
- B) If you insert the disk with the wrong side up, damage to the diskette will occur.

4. Push down on the disk in/out bar until it snaps into place.

Note: To remove the disk from the unit, push the eject button. If the diskette doesn't pop out the first time, just press the eject button again.

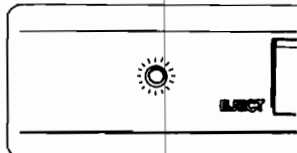

Figure 12

When the access indicator is lit, don't remove the disk from the unit.

Loading the file management software

1. Before loading the file management software into your Portable Computer, be sure that all of the DIP switches are in the ON position. (Refer to the next section, **Setting the DIP switches of the Portable Disk Drive.**)
2. Turn on the Portable Computer and the Portable Disk Drive. Insert your utility diskette.
3. You will automatically enter the main Menu of the Portable Computer. With the cursor over the word **BASIC** , press **ENTER** .

General information

4. Type in the following program (Be sure to use all capital letters):

```
10 OPEN"COM:88N1DMM"FOR OUTPUT AS#1
20 PRINT#1,"S10985157C00AD7EF08B3AS901FE"
30 LOAD"COM:88N1ENNA",R
SAVE"IPL.BA"
```

5. To exit BASIC and return to the Menu, press **F8**.

6. Highlight the program name IPL.BA with the cursor. Then run the program simply by pressing **ENTER**.

The following message will be displayed:

```
---INITIAL PROGRAM LOADER---
      WAIT A MINUTE!

now loading file-manager
```

Notes:

- A) If this message does not appear on the LCD, you may have made a mistake in programming. Press **SHIFT** **BREAK**; when the Ok prompt appears, type: `LOAD"IPL"`. List and check the program; edit it, if necessary. Then run the program again.
- B) If "OM Error" appears on the screen, your Portable Computer does not have enough free memory to run the IPL program. (You need at least 8K of free RAM.) To resolve this problem, just kill some files and try again.
- C) If the low battery indicator on the Disk Drive flickers, the DIP switches on the bottom of the Portable Disk Drive are not set correctly. See the next section (**Setting the DIP switches of the Portable Disk Drive**) and set all four switches to the ON position. Then begin again with step 2.
- D) After running the IPL program, the terminal setting for Telcom will need to be changed back to your normal settings. Refer to your Portable Computer owner's manual for information on changing these settings.
- E) Check your system date and time. Loading the file management software may cause this date and time to change.

7. After about 20 seconds, the LCD will return to the Menu automatically. You will find " FLOPPY.CO " in the Menu.

Now all of the file management programs are stored in the RAM of the Portable Computer.

Note: " FLOPPY.CO " is the file name of the file management program. If you do not find " FLOPPY.CO " on the main Menu, the program was not successfully loaded. Chances are that there was not enough free memory. (You need to have at least 8K of free RAM available.) Kill some files and try again, beginning with step 2 above.

8. If you should have any problems with your system locking up while loading " FLOPPY.CO ", press **SHIFT** **BREAK** to free up the system and **F8** to return to the main Menu. Eject the diskette and turn the Portable Disk Drive's power switch to OFF; then begin again with step 2 above.

Setting the DIP switches of the Portable Disk Drive

Before you use the Portable Disk Drive, set the DIP switches on the bottom side of the Portable Disk Drive. Follow these steps.

1. Remove the diskette from the Portable Disk Drive.
2. Turn off the power switch of the Portable Disk Drive.
3. Turn the Portable Disk Drive upside down, and you will see the DIP switch cover.
4. Remove the DIP switch cover by inserting the tip of a pen or a screwdriver into the small opening so that the cover pops off. Then you will be able to see all four switches.

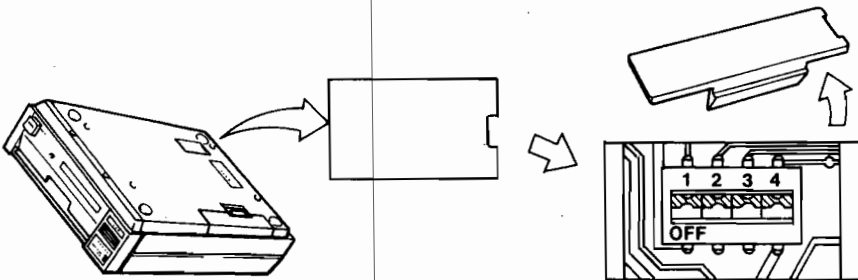

Figure 13

General information

5. Change the position of the four switches to the OFF position if you will now be using the file management program. Change the switch positions to ON if you are just starting-up the system and loading the file management program.

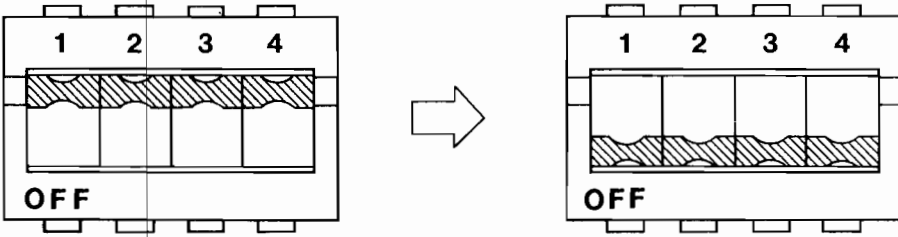

Figure 14

Important Note!

If you don't set the DIP switches, the file management software will not work. If you try to use it without setting these switches, the low battery indicator of the Portable Disk Drive will flicker on and off very fast to remind you. Remove the diskette from the Drive, turn off the power and set the DIP switches to their correct positions.

File management 2

File management functions

The Portable Disk Drive performs the following file management functions:

Command	Key	Function
Files	F1	Displays the file names of all the DO , BA and CO files on the disk to the Portable Computer's LCD.
Load	F2	Loads the DO , BA or CO file on the disk to the Portable Computer.
Save	F3	Saves the DO , BA or CO file in the RAM of the Portable Computer to the disk.
Bkup	F4	Duplicates information from one disk to another.
Kill	F5	Erases the DO , BA or CO file on the disk.
Name	F6	Changes the file name on the disk.
Format	F7	Formats the disk.
Menu	F8	Exits and returns to the main Menu of the Portable Computer.

Table 1

File management start-up

Before you start-up the system, make sure that the DIP switches are set correctly. (Refer to **Setting the DIP switches of the Portable Disk Drive.**)

1. Turn on the power switches of the Portable Computer and the Portable Disk Drive. Insert a diskette.
2. In the main Menu on the LCD of the Portable Computer, move the cursor to **FLOPPY.CD** and press **ENTER**.
3. The following command menu appears on the LCD:

File management

```
Disk File Manager  Ver.01.00.00
                                00:00:00
F1: Files      F2: Load
F3: Save       F4: Bkup
F5: Kill       F6: Name
F7: Format     F8: Menu

Select F1 - F8 ?      xxxxx Bytes free
```

00:00:00 is "hour:minute:second" which is the same as the time shown on the main Menu.

xxxxx Bytes free indicates the amount of free RAM available in your Portable Computer.

4. By pressing any of the **F1** - **F8** keys, you can select and execute the commands of the file management program.

Notes:

- A) If you should choose to load another machine language program (e.g., Spectaculator) into the RAM of your Portable Computer, that program may be written over the file management program that resides in high memory. If this happens, you will need to reload `FLOPPY.CO` into high memory. To do this, go into `BASIC`. If you are using a Model 100 Portable Computer, type: `CLEAR 256,59400`. For TANDY 200, type: `CLEAR 256,57500`. Exit back to the main Menu. Then highlight the file `FLOPPY.CO` and press **ENTER** to run the program.
- B) Also note that, once loaded, `FLOPPY.CO` is stored in both high and low memory, even after you return to the main Menu (see the free memory number on the main Menu decreased). To clear the file management program from high memory, go into `BASIC` and type `CLEAR 256,MAXRAM` **ENTER**. To remove `FLOPPY.CO` from the main Menu, go into `BASIC` and type: `KILL "FLOPPY.CO"`. This will completely eliminate `FLOPPY.CO` from your Portable Computer.

Commands

Files

1. When the command menu appears on the LCD, press **[F1]**.
2. All file names and their file size (in bytes) will be displayed.
For example:

```

AMERIC.DO    2300    BCC    .BA    699
CANADA.DO    5829    F5HC    .BA    59
TTCFG .BA    49      WGH50 .CO    2119

```

Note: File names are displayed with up to 12 or 28 names on one screen, depending on the Portable Computer you are using. If there are more than 12 or 28 names, press any key. Then the rest of the file names will be displayed on the next screen. There can be a maximum of 40 file names on each diskette.

3. At the bottom of the last screen of file names on the disk, you will see the amount of free space available on the disk.
For example:

```

15600 Bytes free
Hit any Key.

```

4. Press any key, and the LCD will return to the command menu.

Load

1. When the command menu appears on the LCD, press **[F2]**.
2. The Portable Computer will ask you which file you want to load from the disk.

```
File Load
```

```
File Name on Disk:
```

3. After you type in the file name with the appropriate extension (e.g., TANDY.DO **[ENTER]**), the Portable Computer will ask you for the file name in RAM to which this disk file is to be loaded.

```
File Name on RAM :
```

If you want to assign the same file name as on disk, just press **[ENTER]**. The Portable Computer will name the file in RAM the same as on disk.

File management

Note: The extension (file type, **.DO**, **.BA**, **.CO**) of the file name in RAM will automatically be the same as on the disk file name, even if you don't key it in. If you key in a different extension, the Computer will disregard it and make the extension the same anyway.

4. If the file name designated in step 3 already exists in RAM, the Portable Computer will ask you:

Already Exists. Are you sure? (Y/N)

If you want to overwrite the existing file in RAM and load the file from disk, press Y ENTER .

If you don't want to overwrite the existing file in RAM, press N ENTER .

Then the LCD will return to the command menu.

Note: If the free RAM area on the Portable Computer is not sufficient to load the file, "Lack of Space" will be displayed. This means you will need to kill some files.

5. After loading a file, you will see the following message:

Ok
Hit any Key.

6. Press any key, and the LCD will return to the command menu.

Save

1. When the command menu appears on the LCD, Press F3 .
2. The Portable Computer will ask you which file you want to save from RAM:

File Save

File Name on RAM :

3. After you type in the file name with the appropriate extension (e.g., AAA.D0), the Portable Computer will ask you for the file name on the disk to which the RAM file is to be saved.

File Name on Disk:

If you want to assign the same file name as in RAM, just press . The Portable Computer will name the file on disk the same as in RAM.

Note: The extension (file type) of the file name on disk will automatically be the same as that of the RAM file, even if you don't key it in. If you key in a different extension, the Computer will disregard it and make the extension the same anyway.

4. If the file name designated in step 3 already exists on disk, the Portable Computer will ask you:

Already Exists. Are you sure? (Y/N)

If you want to overwrite the existing file on disk and save the file from RAM, press .

If you don't want to overwrite the existing file on disk, press .

Then the LCD will return to the command menu.

Note: If the free area on the disk is not sufficient to save the file, "Lack of Space" will be displayed. This means you will need to kill some files or use another disk with more free area.

5. After saving a file, you will see the following message:

Ok
Hit any Key.

6. Press any key, and the LCD will return to the command menu.

Note: If you attempt to save a file to a diskette that is only partially formatted, the file may not be properly saved, even though the "Ok" prompt appears on the LCD. After you save a file on a newly-formatted disk, press (the Files command) to be sure the file was properly saved. If it was not, begin again by re-formatting the disk.

Bkup

Note: Before you execute the Bkup command, write-protect the source diskette so that source data will not be erased. Follow the instructions in the **Diskette** section.

1. When the command menu appears on the LCD, press .
2. The following message will appear on the LCD:

Insert Blank Disk. Are you sure? (Y/N)

After you insert the blank disk, press .

If the disk contains data, the Portable Computer will ask you:

Diskette Contains Data.
Continue? (Y/N)

If you want to retain the data and stop the backup procedure, respond by pressing ; the display will return to the command menu. If you want to continue, respond by pressing . The Portable Disk Drive will begin formatting the blank disk and the message "Formatting..." will be displayed on the LCD at the same time. It will take about 100 seconds.

3. After formatting, the following message will be displayed:

Insert Source Disk, then Hit any Key. **[Reading
hard sector No.]**

After you insert the source disk, press any key.

4. The following message will be displayed:

Insert Blank Disk, then Hit any Key. **[Writing
hard sector No.]**

After you insert the blank disk again, press any key.

5. Repeat steps 3 and 4, until all data is copied from the source disk to a blank disk.

Note: The number of hard sectors copied at one time depends on the amount of free space available in RAM.

If a lot of free space is available in RAM, fewer disk changes will be required.

For your reference, the hard sector number being accessed is displayed at each Bkup operation.

After backing-up all data, you will see the following message:

```
Ok
Hit any Key.
```

6. Press any key, and the LCD will return to the command menu.

Note: If a mistake is made in the disk change operation, or if an error has occurred, the LCD will prompt you as follows:

```
Abort
Continue? (Y/N)
```

A) If you want to attempt the backup procedure again, press Y ENTER .
The following message will be displayed:

```
Insert Source Disk, then Hit any Key.
```

Proceed to backup according to the messages on the LCD, as in steps 3 and 4 above.

B) If you want to stop the backup procedure, press N ENTER .
The LCD will return to the command menu.

Notes:

A) To stop the backup procedure once it has begun, press SHIFT BREAK .

B) Use the F1 command to verify that a complete backup was accomplished.

Kill

1. When the command menu appears on the LCD, press .
The Computer will ask you for the name you want to erase.

Erase File Name:

2. After you type in the file name (e.g., USA.DO), the Portable Computer will make sure you want to erase the file:

Are you sure? (Y/N)

- A) If you key in , the file will be erased and you will see the following message:

Ok
Hit any Key.

The LCD will return to the command menu.

- B) If you don't want to erase this file, press .
The LCD will return to the command menu.

Name

1. When the command menu appears on the LCD, press .
2. The Portable Computer will ask you which file you want to rename:

Rename
Old File Name on Disk:

3. After you key in the file name (e.g., TANDY.DO), the Computer will ask you for the new file name.

New File Name on Disk:

4. Key in the new file name (e.g., RADIOS.D0).

If a file with the same name as the one you just entered already exists on disk, the Computer will tell you:

Already Exists
Hit any Key.

Press any key, and the LCD will return to the command menu.

Note: The extension (file type) of the file name in the new name will be the same as in the old one, even if you don't key it in.

If you key in a different extension, the Computer will disregard it and make the extension the same anyway.

Sometimes it will take 20 seconds to execute a rename.

5. After renaming, you will see the following message:

Ok
Hit any Key.

The LCD will return to the command menu.

Note: Do not press to stop renaming.

Format

1. When the command menu appears on the LCD, press .
2. The Portable Computer will make sure you want to format the disk.

Format. Are you sure? (Y/N)

- A)After you insert the disk, press . If the disk contains data, the Portable Computer will ask you:

Diskette Contains Data.
Continue? (Y/N)

File management

If you want to retain the data and stop the formatting procedure, respond by pressing N ENTER ; the display will return to the command menu. If you want to continue, respond by pressing Y ENTER . While the Portable Computer is formatting the disk, the LCD will display the message “ Formatting ... ”. It will take about 100 seconds to format.

After formatting, you will see the following message:

```
Ok
Hit any Key.
```

· Press any key, and the LCD will return to the command menu.

B) If you don't want to format the disk, press N ENTER .

The LCD will return to the command menu.

Note: If you interrupt the formatting process by pressing SHIFT BREAK , the Portable Disk Drive will continue to access the disk. If this happens, the disk may not be completely formatted.

Menu

When you want to return to the main Menu of the Portable Computer, press F8 . The LCD returns to the main Menu.

Error messages 3

When errors occur in the system, the display will show an error message. These error messages are listed below, along with some possible causes for each one. If you should get an error message, press any key to return to the command menu.

Drive not Ready

1. The Drive is not turned on or batteries installed in the Drive are exhausted.
2. The cable is not connected.
3. The Drive has a mechanical problem.
4. The Drive is formatting a disk.
5. DIP switches are set to ON.

Communication Error

1. During communication with the Computer, the power to the Drive is cut off.
2. During communication with the Computer, the cable is disconnected from the Portable Computer and/or from the Drive.
3. During communication with the Computer, a checksum error occurs.

Abort

1. By pressing **SHIFT** **BREAK**, the command being executed is stopped.
2. Abort occurs if you change the diskette while executing the Name command.

File not Found

1. The file designated doesn't exist in the RAM of the Computer or on disk.

Already Exists

1. The file designated already exists in the RAM of the Computer or on disk.

Lack of Space

1. The free area for creating a new file is lacking in the RAM of the Computer or on disk.
2. When executing the Name or Bkup command, the working area in the RAM of the Computer is insufficient.

Error messages

Write Protected

1. The disk is write-protected; the Drive cannot write the data to the disk.

Hard Trouble

1. When this message is displayed, return to the command menu; eject the diskette and turn the Drive off and on. If this message is still displayed repeatedly, there is a mechanical problem in the Drive.

Disk I/O Error

1. The data on the disk is destroyed.
2. The disk is not formatted.
3. The disk is physically damaged.
4. The Drive has a mechanical problem.

Disk not In

1. The disk is not inserted in the Drive.

File Empty

1. An attempt was made to save a file with no data.

Invalid File Type

1. An attempt was made to load a file type other than **.BA**, **.DO** or **.CO**.

Appendices

Specifications **A**

Storage capacity (Formatted)

Per disk	101.12K bytes
Per track	2,560 bytes
Per hard sector	1,280 bytes

Disk

Number of surfaces	1
Number of memory blocks	
Total number of tracks	40
Total number of hard sectors	80

Recording systems

Recording method	FM
Recording density	4,064 BPI
Track density	67.5 TPI
Data transfer rate	125K bits/sec.

Process time

Average access time	820 ms
Track to track	60 ms
Settling time	20 ms
Motor start time	1 s

Rotational speed 300 rpm

Number of Index 2

Power sources 4 AA alkaline batteries
(Cat. No. 23-552)
or
AC Adapter
(Cat. No. 26-3804)

Specifications

Power consumption	Operating	1.5 W
	Waiting	0.16W
Battery life	Continuous Read/Write	
	Minimum 2 hours	
	Waiting only	
	Minimum 10 hours	
Low Battery	Alarm lamp average voltage	4.1V
	Power down average voltage	3.7V
Weight	1 lb 14 oz	
	850 grams	
	(Including 4 batteries)	
Dimensions	5-1/4" × 6-13/32" × 2-1/8"	
	133 (W) × 163 (L) × 54 (H) m/m	
Media used	3.5-inch micro floppy disk	
	Single sided	
Interface	RS-232C	
Transfer rate	Booting	9600 bits/sec.
	Operating	19200 bits/sec.

Schematic diagram

B

Main PCB

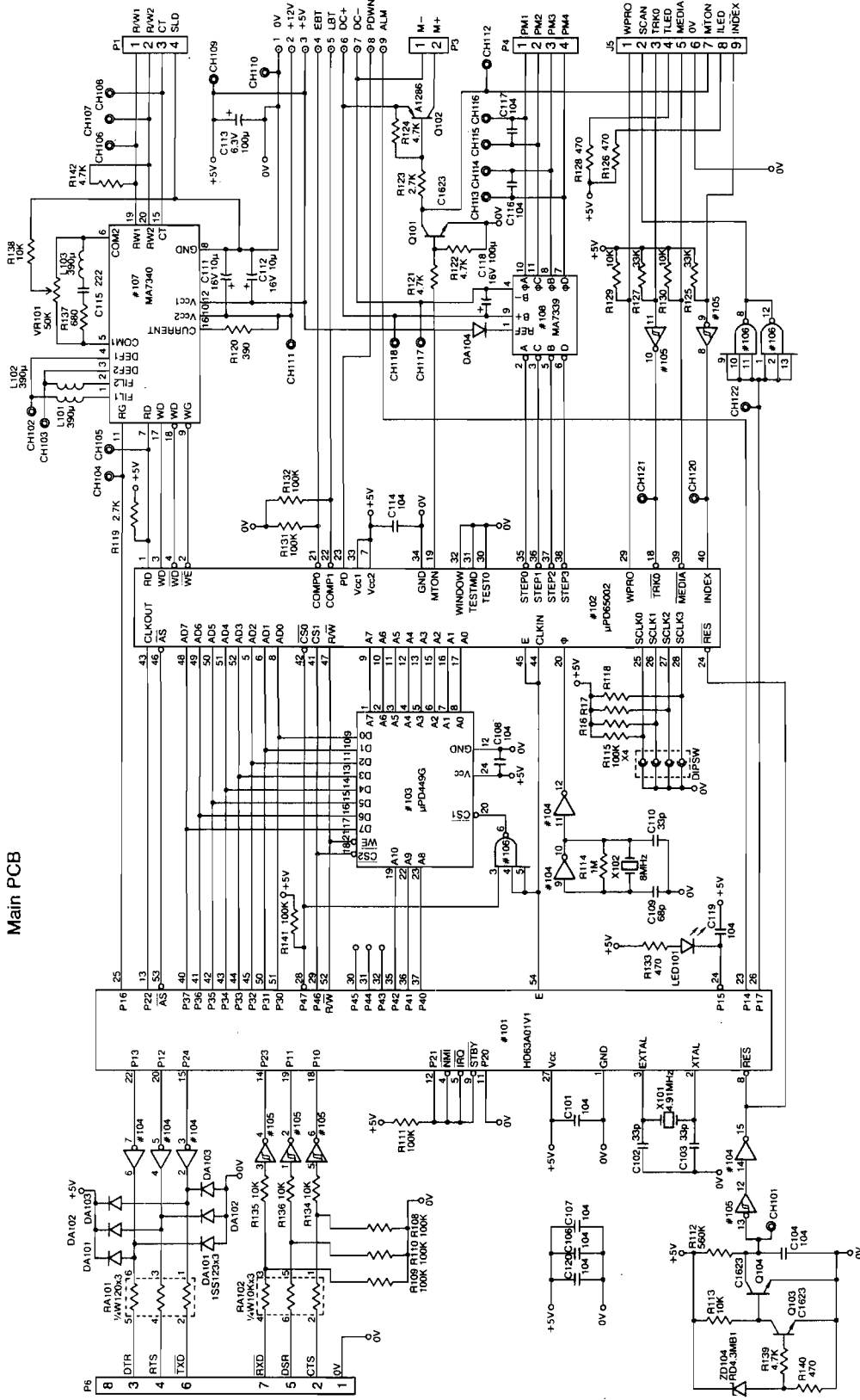

NOTES:
 A) RATED POWER OF UNSPECIFIED RESISTOR: 1/8W
 B) #104: TC50H000F, #105: TC4584F, #106: TC40H010F

SERVICE POLICY

Radio Shack's nationwide network of service facilities provides quick, convenient, and reliable repair services for all TANDY/Radio Shack computer products, in most instances. Warranty service will be performed in accordance with Radio Shack's Limited Warranty. Non-warranty service will be provided at reasonable parts and labor costs.

Because of the sensitivity of computer products, and the problems which can result from improper servicing, the following limitations also apply to the services offered by Radio Shack:

1. If any of the warranty seals on any Radio Shack and Tandy computer products it sells are broken, Radio Shack reserves the right to refuse to service the product or to void any remaining warranty on the product.
2. If any computer product purchased from Radio Shack has been modified so that it is not within manufacturer's specifications, including, but not limited to, the installation of any non-Radio Shack parts, components, or replacement boards, then Radio Shack reserves the right to refuse to service the product, void any remaining warranty, remove and replace any non-Radio Shack part found in the product, and perform whatever modifications are necessary to return the product to original factory manufacturer's specifications.
3. The cost for the labor and parts required to return the computer product to original manufacturer's specifications will be charged to the customer in addition to the normal repair charge.

**CUSTOM MANUFACTURED FOR RADIO SHACK,
A DIVISION OF TANDY CORPORATION**

**U.S.A.: FORT WORTH, TEXAS 76102
CANADA: BARRIE, ONTARIO L4M 4W5**

TANDY CORPORATION

AUSTRALIA

**91 KURRAJONG AVENUE
MOUNT DRUITT, N.S.W. 2770**

BELGIUM

**PARC INDUSTRIEL
5140 NANINNE (NAMUR)**

U. K.

**BILSTON ROAD WEDNESBURY
WEST MIDLANDS WS10 7JN**